

ELECTRONIC CASH REGISTER

TE-4000F

TE-4500F

User's Manual



TE-4000F



TE-4500F

**Introduction**

*Setting Up*

**Getting Started**

*Paper Installation*

*Set Date/time*

**Introducing the Terminal**

*Display/Keyboard*

*Sheet Holder*

**Basic Operations & Setups**

*Registrations*

*Programs*

**Advanced Operations**

*Useful Features*

*Reports*

**Troubleshooting**

*Error Code Table*

**User Maintenance**

*Paper Replacement*

Eu

Di

U.K.

CI

Canada

**CASIO®**



# Introduction

Congratulations on your selection of a CASIO TE-4000F/4500F series electronic cash register. This ECR is the product of the world's most advanced electronic technology, for outstanding versatility and reliability. Simplified operation is made possible by a specially designed keyboard layout and a wide selection of automated, programmable functions.

A specially designed keyboard layout and a bright, easy-to-read display help to take the fatigue out of long hours operation.



Casio Electronics Co., Ltd.  
Unit 6, 1000 North Circular Road  
London NW2 7JD, U.K.

**WARNING:** This is a Class A product. In a domestic environment this product may cause radio interference in which case the user may be required to take adequate measures.

*Please keep all information for future reference.*

## GUIDELINES LAID DOWN BY FCC RULES FOR USE OF THE UNIT IN THE U.S.A. (Not applicable to other areas)

**WARNING:** This equipment has been tested and found to comply with the limits for a Class A digital device, pursuant to Part 15 of the FCC Rules. These limits are designed to provide reasonable protection against harmful interference when the equipment is operated in a commercial environment. This equipment generates, uses, and can radiate radio frequency energy and, if not installed and used in accordance with the instruction manual, may cause harmful interference to radio communications. Operation of this equipment in a residential area is likely to cause harmful interference in which case the user will be required to correct the interference at his own expense.

**FCC WARNING:** Changes or modifications not expressly approved by the party responsible for compliance could void the user's authority to operate the equipment.

Apparaten skall anslutas till jordat nätuttag.

The main plug on this equipment must be used to disconnect mains power. Please ensure that the socket outlet is installed near the equipment and shall be easily accessible.

---

## Safety Precautions

- To use this product safely and correctly, read this manual thoroughly and operate as instructed.  
After reading this guide, keep it close at hand for easy reference.  
Please keep all informations for future reference.
- Always observe the warnings and cautions indicated on the product.

## About the icons

In this guide various icons are used to highlight safe operation of this product and to prevent injury to the operator and other personnel and also to prevent damage to property and this product. The icons and definitions are given below.



Indicates that there is a risk of severe injury or death if used incorrectly.



Indicates that injury or damage may result if used incorrectly.

## Icon examples

To bring attention to risks and possible damage, the following types of icons are used.



The  $\triangle$  symbol indicates that it includes some symbol for attracting attention (including warning). In this triangle the actual type of precautions to be taken (electric shock, in this case) is indicated.



The  $\otimes$  symbol indicates a prohibited action. In this symbol the actual type of prohibited actions (disassembly, in this case) will be indicated.



The  $\bullet$  symbol indicates a restriction. In this symbol the type of actual restriction (removal of the power plug from an outlet, in this case) is indicated.

---

## Warning!

---

## Handling the register



**Should the register malfunction, start to emit smoke or a strange odor, or otherwise behave abnormally, immediately shut down the power and unplug the AC plug from the power outlet. Continued use creates the danger of fire and electric shock.**

- Contact CASIO service representative.



**Do not place containers of liquids near the register and do not allow any foreign matter to get into it. Should water or other foreign matter get into the register, immediately shut down the power and unplug the AC plug from the power outlet. Continued use creates the danger of shorting, fire and electric shock.**

- Contact CASIO service representative.



**Should you drop the register and damage it, immediately shut down the power and unplug the AC plug from the power outlet. Continued use creates the danger of shorting, fire and electric shock.**

- Attempting to repair the register yourself is extremely dangerous. Contact CASIO service representative.
-

## ⚠ Warning!



**Never try to take the register apart or modify it in any way. High-voltage components inside the register create the danger of fire and electric shock.**

- Contact CASIO service representative for all repair and maintenance.

### Power plug and AC outlet



**Use only a proper AC electric outlet (100V~240V) . Use of an outlet with a different voltage from the rating creates the danger of malfunction, fire, and electric shock. Overloading an electric outlet creates the danger of overheating and fire.**



**Make sure the power plug is inserted as far as it will go. Loose plugs create the danger of electric shock, overheating, and fire.**

- Do not use the register if the plug is damaged. Never connect to a power outlet that is loose.



**Use a dry cloth to periodically wipe off any dust built up on the prongs of the plug. Humidity can cause poor insulation and create the danger of electric shock and fire if dust stays on the prongs.**



**Do not allow the power cord or plug to become damaged, and never try to modify them in any way. Continued use of a damaged power cord can cause deterioration of the insulation, exposure of internal wiring, and shorting, which creates the danger of electric shock and fire.**

- Contact CASIO service representative whenever the power cord or plug requires repair or maintenance.

## ⚠ Caution!



**Do not place the register on an unstable or uneven surface. Doing so can cause the register — especially when the drawer is open — to fall, creating the danger of malfunction, fire, and electric shock.**



**Do not place the register in the following areas.**

- Areas where the register will be subject to large amounts of humidity or dust, or directly exposed to hot or cold air.
- Areas exposed to direct sunlight, in a close motor vehicle, or any other area subject to very high temperatures.

**The above conditions can cause malfunction, which creates the danger of fire.**



**Do not overlay bend the power cord, do not allow it to be caught between desks or other furniture, and never place heavy objects on top of the power cord. Doing so can cause shorting or breaking of the power cord, creating the danger of fire and electric shock.**



**Be sure to grasp the plug when unplugging the power cord from the wall outlet. Pulling on the cord can damage it, break the wiring, or cause short, creating the danger of fire and electric shock.**



**Never touch the plug while your hands are wet. Doing so creates the danger of electric shock. Pulling on the cord can damage it, break the wiring, or cause short, creating the danger of fire and electric shock.**

**Never touch the printer head and the platen.**

# Introduction & Contents

---

<b>Introduction &amp; Contents</b> .....	<b>3</b>
<b>Getting Started</b> .....	<b>10</b>
Remove the cash register from its box. ....	10
Remove the tape holding parts of the cash register in place. ....	10
Remove the cash drawer from its box. ....	10
Connect the drawer. ....	10
Mount the cash register. ....	11
Plug the cash register into a wall outlet. ....	11
Insert the mode key marked "OW" into the mode switch. ....	11
Install receipt/journal paper. ....	12
Set the date. ....	15
Set the time. ....	15
<b>Introducing TE-4000F/4500F</b> .....	<b>16</b>
General guide .....	16
Display .....	20
Keyboard (TE-4000F) .....	22
Keyboard (TE-4500F) .....	24
Allocatable functions .....	26
How to remove/replace the sheet holder (TE-4000F only) .....	28
How to install a menu sheet in the sheet holder (TE-4000F only) .....	29
<b>Basic Operations and Setups</b> .....	<b>30</b>
How to read the printouts .....	30
How to use your cash register .....	31
Assigning a clerk .....	32
Clerk button .....	32
Clerk lock/clerk key .....	32
Clerk secret number key .....	32
Displaying the time and date .....	33
To display and clear the date/time .....	33
Preparing coins for change .....	33
Preparing and using department/flat-PLU keys .....	34
Registering department/flat-PLU keys .....	34
Programming department/flat-PLU keys .....	35
To program a unit price for each department/flat-PLU .....	35
To program the tax calculation status for each department/flat-PLU .....	35
To program high amount limit for each department/flat-PLU .....	36
Registering department/flat-PLU keys by programming data .....	37
Preset price .....	37
Preset tax status .....	37
Locking out high amount limitation .....	37
Preparing and using PLUs .....	38
Programming PLUs .....	38
To program a unit price for each PLU .....	38
To program tax calculation status for each PLU .....	38
Registering PLUs .....	39
Shifting the taxable status of an item .....	41
Calculation merchandise subtotal .....	41
Preparing and using discounts .....	42
Programming discounts .....	42
Registering discounts .....	42
Discount for items and subtotals .....	42
Preparing and using reductions .....	43
Programming for reductions .....	43
To program preset reduction amount .....	43

Registering reductions .....	43
Reduction for items .....	43
Reduction for subtotal .....	44
Registering credit and check payments .....	45
Check .....	45
Credit .....	45
Mixed tender (cash, credit and check) .....	45
Registering both the Euro and local currency .....	46
Registering returned goods in the REG mode .....	48
Registering returned goods in the RF mode .....	48
Normal refund transaction .....	48
Reduction of amounts paid on refund .....	49
Registering money received on account .....	49
Registering money paid out .....	49
Registering loan amounts .....	50
Registering pick up amounts .....	50
Changing media in drawer .....	50
Making corrections in a registration .....	51
To correct an item you input but not yet registered .....	51
To correct an item you input and registered .....	52
To cancel all items in a transaction .....	53
No sale registration .....	53
Printing the daily sales reset report .....	54
<b>Advanced Operations .....</b>	<b>56</b>
Stock check .....	56
Clerk interrupt function .....	56
Single item cash sales .....	57
Addition .....	58
Addition (plus) .....	58
Premium (%+) .....	59
Tray total .....	60
Tray total premium/discount .....	60
Multiple item totalling function .....	60
Coupon transactions .....	61
Coupon registration using <COUPON> (coupon key) .....	61
Coupon registration using <COUPON2> (coupon 2 key) .....	61
Registering the second unit price .....	62
Preset tender amount .....	63
Bottle link operation .....	64
Bottle returns .....	64
Bottle return key .....	64
Arrangement key registrations .....	65
Set menu .....	65
Currency exchange function .....	66
Registering foreign currency .....	66
Full amount tender in foreign currency .....	66
Partial tender in a foreign currency .....	67
Food stamp function .....	68
Food stamp registration .....	68
No change due .....	68
Mixed food stamp/cash change .....	69
Food stamp registration (Illinois rule) .....	71
No change due .....	71
Mixed food stamp/cash change .....	73

# Introduction & Contents

---

Electronic benefits transfer .....	75
About mixed EBT card tenders .....	75
No change due .....	75
Tips .....	76
Inputting the number of customers .....	77
Temporarily releasing compulsion .....	78
Text recall .....	78
Printing slip .....	79
Printing slips .....	79
To perform auto batch printing 1 .....	80
To perform auto batch printing 2 .....	80
About the maximum number of slip lines .....	80
Check tracking systems .....	80
Check tracking system .....	80
Opening a check .....	81
Adding to a check .....	81
Issuing a guest receipt .....	82
Closing a check memory .....	82
New/old check key operation .....	83
Add check .....	84
Separate check .....	85
Clerk transfer .....	86
Table transfer .....	86
Price reductions (red price) .....	87
Condiment/preparation PLUs .....	88
VAT breakdown printing .....	89
Deposit registrations .....	89
Deposit from customer .....	89
Deposit from customer during sales transaction .....	89
Bill copy .....	90
Actual stock quantity inquiry .....	91
Unit price inquiry .....	91
Previous item void using <review> .....	92
Scanning PLU .....	93
Item registration .....	93
By scanner/code input/one touch NLU key .....	93
Not found PLU .....	93
Programming to clerk .....	94
Programming clerk number .....	94
Programming trainee status .....	94
Programming commission rate .....	94
Programming descriptors and messages .....	95
Programming receipt message, machine No. and clerk name .....	95
Programming department/transaction key descriptor .....	97
Programming flat-PLU descriptor .....	98
Entering characters .....	99
Using character keyboard .....	99
Entering characters by code .....	100
Character code list .....	100
Editing characters .....	101
Correcting a character just entered .....	101
Correcting and adding a PLU descriptor already set .....	101
Correcting a key descriptor already set .....	101
Correcting a message descriptor already set .....	101



Printing read/reset reports .....	102
To print the individual department, PLU/flat-PLU read report .....	102
To print the financial read report .....	103
To print the individual clerk read/reset report .....	103
To print the daily sales read/reset report .....	104
To print the PLU/flat-PLU read/reset report .....	106
To print the hourly sales read/reset report .....	106
To print the monthly sales read/reset report .....	107
To print the group read/reset report .....	107
To print the periodic 1/2 sales read/reset reports .....	108
To print other sales read/reset reports .....	110
Reading the cash register's program .....	111
To print unit price/rate program (except PLU/scanning PLU) .....	111
To print key descriptor, name, message program (except PLU) .....	112
To print the PLU/flat-PLU program .....	113
<b>Troubleshooting .....</b>	<b>114</b>
When an error occurs .....	114
When the register does not operate at all .....	116
Clearing a machine lock up .....	117
In case of power failure .....	117
<b>User Maintenance and Options .....</b>	<b>118</b>
To replace journal paper .....	118
To replace receipt paper .....	119
Options .....	119
<b>Specifications .....</b>	<b>120</b>
<b>Index .....</b>	<b>121</b>

# Getting Started

This section outlines how to unpack the cash register and get it ready to operate. You should read this part of the manual even if you have used a cash register before. The following is the basic set up procedure, along with page references where you should look for more details.

## 1. Remove the cash register from its box.

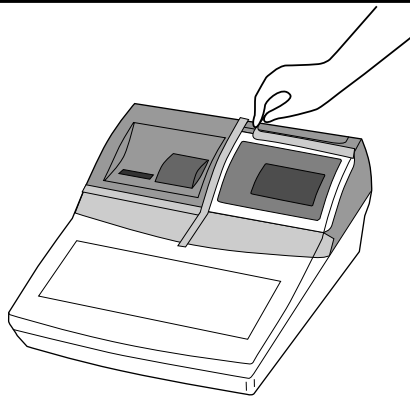
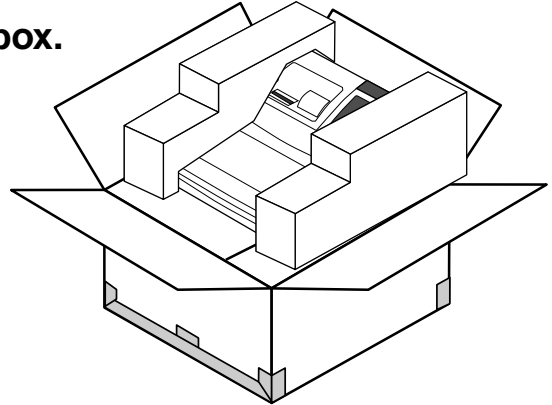

## 2. Remove the tape holding parts of the cash register in place.

Also remove the small plastic bag taped to the printer cover. Inside you will find the mode keys.

## 3. Remove the cash drawer from its box.

The cash register and cash drawer are packed separately.

## 4. Connect the drawer.

1. Connect drawer connector (three color lead on drawer) to the cash register.
2. Connect frame drawer connector (green lead on drawer) to the cash register.

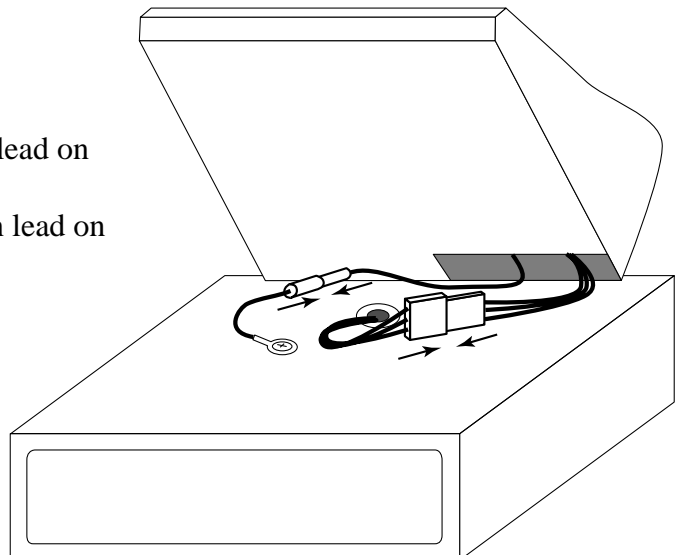

## 5. Mount the cash register.

1. Screw in 2 fixing screws bottom side of the register.
2. Stick rubber plate on the each corner of the bottom side of the register.
3. Mount the cash register on the top of the drawer, ensuring that the feet on the bottom of the cash register go into the holes on the drawer.

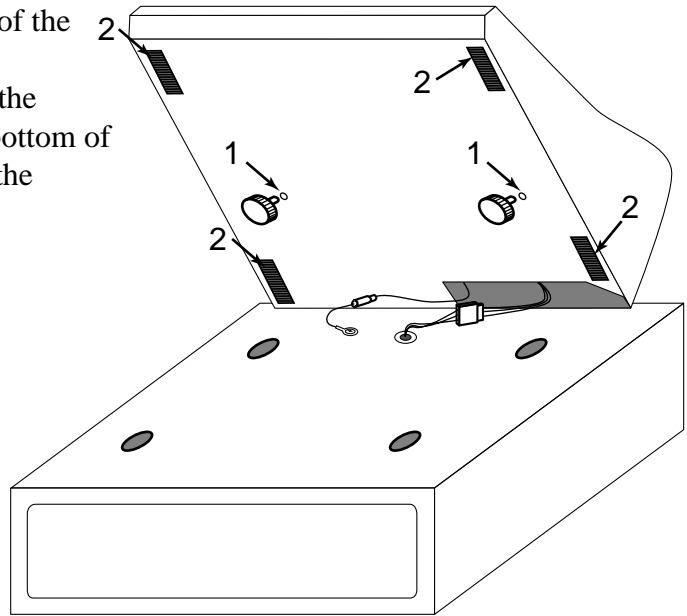

## 6. Plug the cash register into a wall outlet.

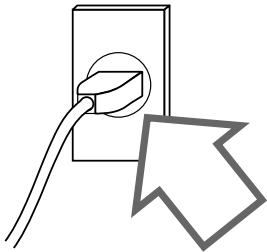

Be sure to check the sticker on the side of the cash register to make sure that its voltage matches that of the power supply in your area. The printer will operate for a few seconds. Please do not pass the power cable under the drawer.

## 7. Insert the mode key marked "OW" into the mode switch.

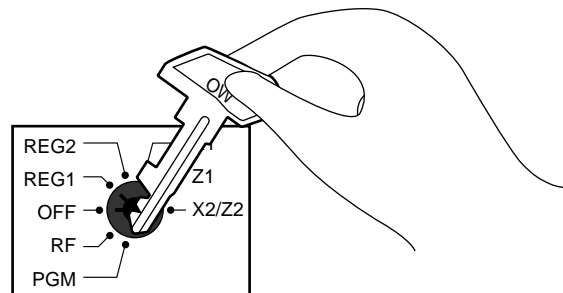

## 8. Install receipt/journal paper.

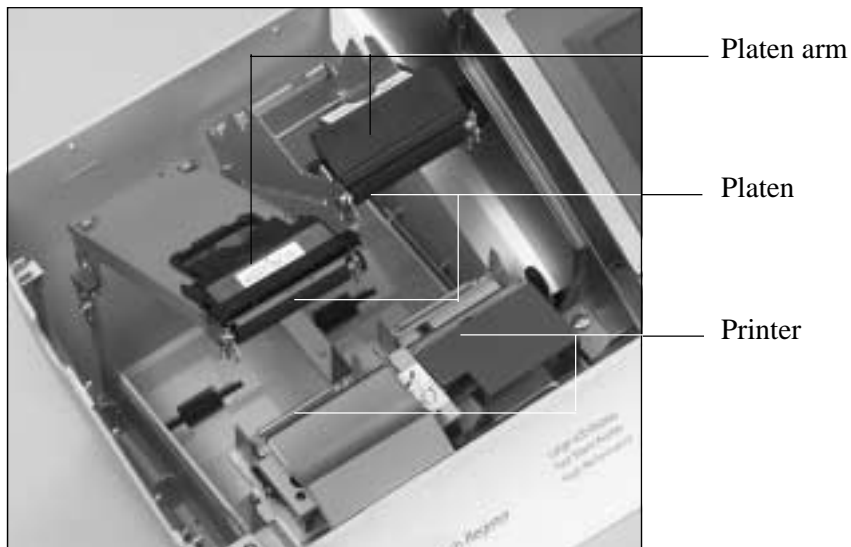

### Important!

Take away the head protection sheet from the printer and close the platen arm.

### Caution! (in handling the thermal paper)

- Never touch the printer head and the platen.
- Unpack the thermal paper just before your use.
- Avoid heat/direct sunlight.
- Avoid dusty and humid places for storage.
- Do not scratch the paper.
- Do not keep the printed paper under the following circumstances:  
High humidity and temperature/direct sunlight/contact with glue, thinner or a rubber eraser.

## To install receipt paper

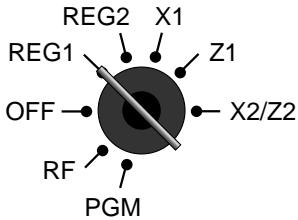

### Step 1

Turn the mode switch to REG1 position.



### Step 2

Remove the printer cover. (If the cover is locked, unlock by using the printer cover key before this step.)



### Step 5

Put the leading end of the paper over the printer.



### Step 3

Open the platen arm.

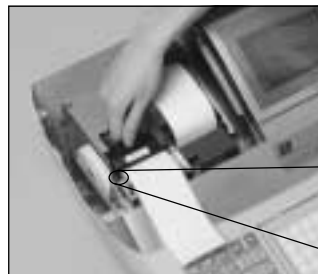

### Step 6

Close the platen arm slowly until it locks steadily.

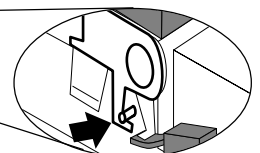

Locking platen

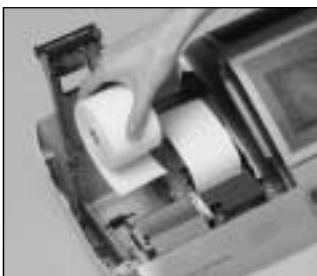

### Step 4

Ensuring the paper is being fed from the bottom of the roll, lower the roll into the space behind the printer.



### Complete

Close the printer cover, passing the leading end of the paper through the cutter slot.

## To install journal paper

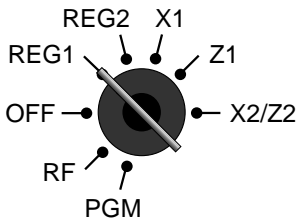

**Step 1**  
Turn the mode switch to REG1 position.

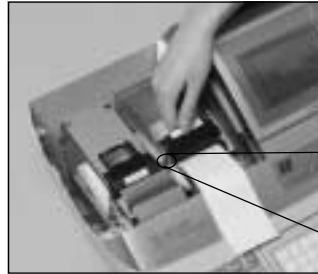

**Step 6**  
Close the platen arm slowly until it locks steadily.

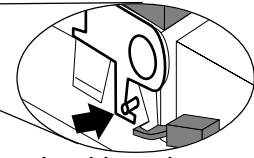

Locking platen



**Step 2**  
Remove the printer cover. (If the cover is locked, unlock by using the printer cover key before this step.)



**Step 7**  
Slide the leading end of the paper into the groove on the spindle of the take-up reel and wind it onto the reel two or three turns.



**Step 3**  
Open the platen arm.



**Step 8**  
Place the take-up reel into place behind the printer, above the roll paper.

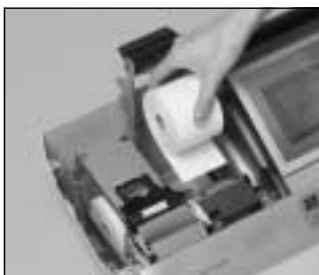

**Step 4**  
Ensuring the paper is being fed from the bottom of the roll, lower the roll into the space behind the printer.



**Step 9**  
Press the **JOURNAL FEED** key to take up any slack in the paper.

During machine installation, press the **JOURNAL FEED** key after power on.



**Step 5**  
Put the leading end of the paper over the printer.



**Complete**  
Close the printer cover.

## 9. Set the date.

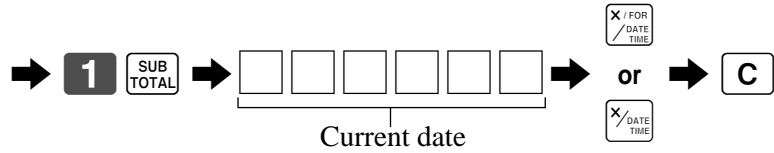
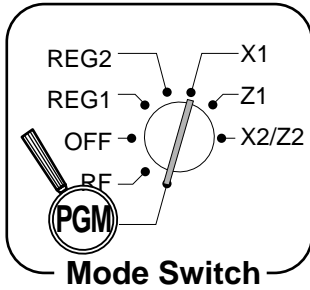

Example:

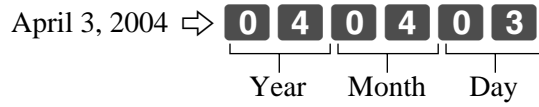

## 10. Set the time.

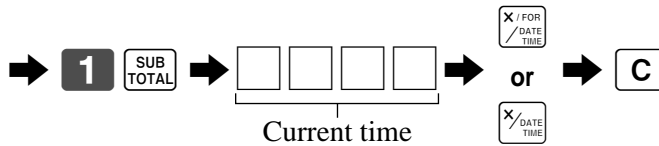
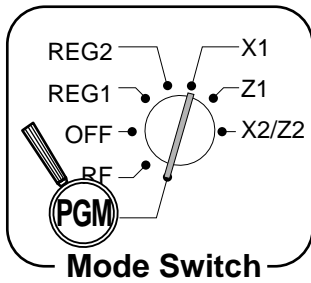

Example:

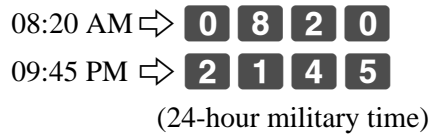

# Introducing TE-4000F/4500F

## General guide

This part of the manual introduces you to the cash register and provides a general explanation of its various parts.

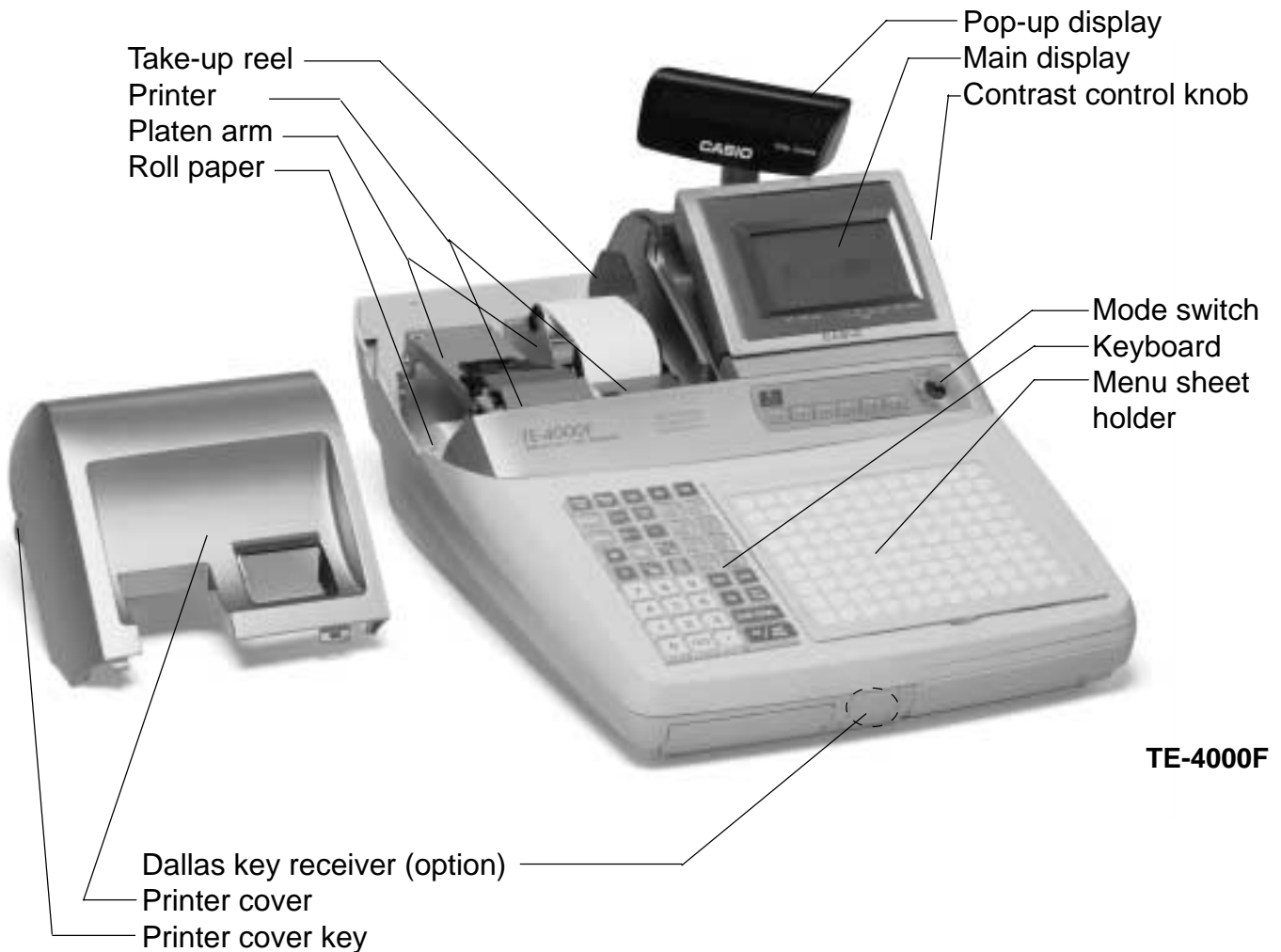

### Roll paper

You can use the roll paper to print receipts and a journal (pages 12 ~ 14).

### Receipt on/off switch / key

Use the receipt on/off switch/key in REG1, REG2 and RF modes to control issuance of receipts. In other modes, receipts or reports are printed regardless the receipt switch/key setting.

A post-finalization receipt can still be issued after finalization when the switch/key is set to off. The cash register can also be programmed to issue a post-finalization receipt even when the switch/key is set to on.

### Receipt on/off switch

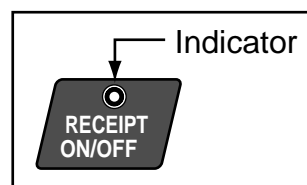

### Receipt on/off key

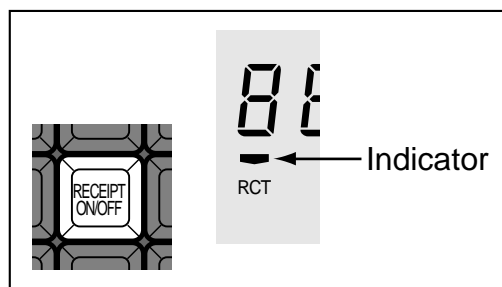

When the register issues receipts, this indicator is lit.



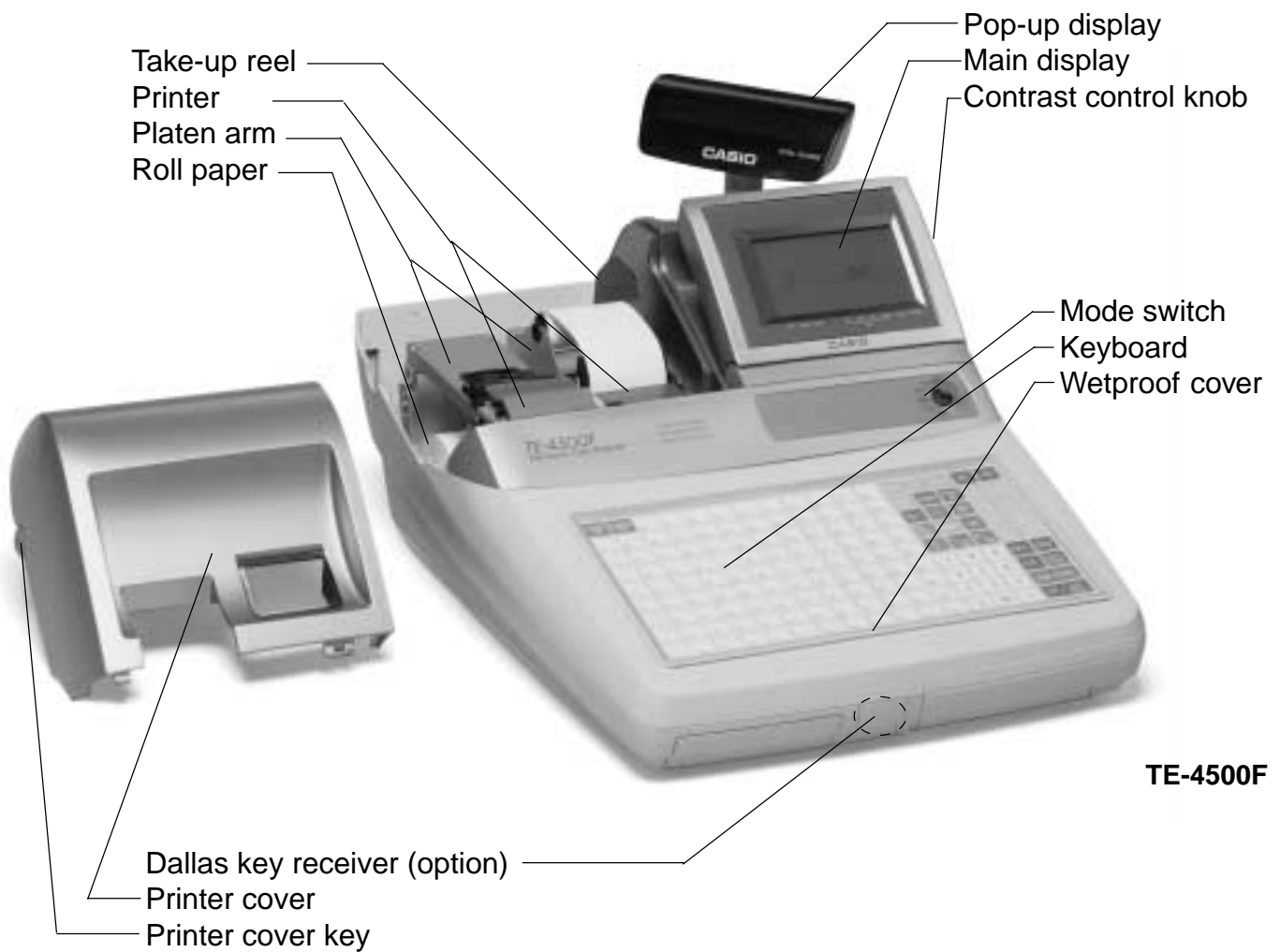

TE-4500F

Introducing TE-4000F/4500F

### Mode key (for U.K., U.S. and Canada)

The following four types of mode keys are provided with the unit in the United Kingdom, the United States and Canada.

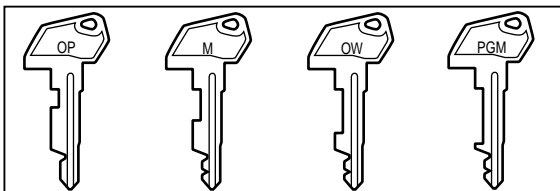

- a. OP (Operator) key  
Switches between OFF and REG1.
- b. M (Master) key  
Switches between OFF, REG1, REG2, X1 and RF.
- c. OW (Owner) key  
Switches between OFF, REG1, REG2, X1, Z1, X2/  
Z2 and RF.
- d. PGM (Program) key  
Switches to any position.

### Mode key (for other area)

The following three types of mode keys are provided with the unit in areas outside of the United Kingdom, the United States and Canada.

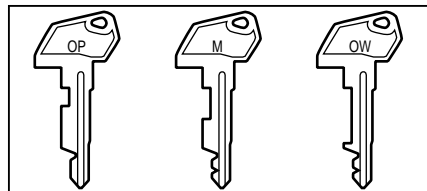

- a. OP (Operator) key  
Switches between OFF and REG1.
- b. M (Master) key  
Switches between OFF, REG1, REG2, X1 and RF.
- c. OW (Owner) key  
Switches to any position.

# Introducing TE-4000F/4500F

## Mode switch

Use the mode keys to change the position of the mode switch and select the mode you want to use.

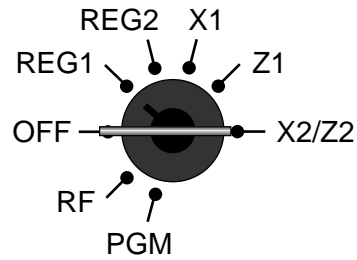

Mode switch	Mode name	Description
<b>OFF</b>	Stand-by	Any of the mode control keys can be inserted and removed from the mode switch in this position.
<b>REG1</b>	Register 1	Used for normal sales transactions. Any of the mode control keys can be inserted and removed from the mode switch in this position.
<b>REG2</b>	Register 2	Used for special operations. Since switching to REG2 requires a special key, such functions as discounts, credit sales, charge sales, check payments, and paid outs can be controlled by programming them as prohibited in REG1 and allowed in REG2.
<b>RF</b>	Refund Reg minus	Used for processing refunds. When the mode switch of the register is in RF position, you can access either the refund mode or the register minus mode.
<b>X1</b>	Daily sales read	Used to obtain daily reports without resetting (clearing) all total data.
<b>Z1</b>	Daily sales reset	Used to obtain daily reports while resetting (clearing) all total data.
<b>X2/Z2</b>	Periodic sale read/ reset	Used to obtain periodic sales reports without resetting total data or while resetting all total data.
<b>PGM</b>	Program	Used when programming functions and preset data such as unit prices and tax rates. Also used when reading program data.

## Clerk key/button/lock

On models available in the United States, Canada and Germany, clerk or cashier assignment can be performed using clerk secret numbers only (clerk buttons are not equipped).

In other areas, you can assign clerks or cashiers by using clerk button or by clerk secret number. The method you are assigning clerk depends on the programming of your cash register.

### Clerk secret number key

When the cash register is programmed to use clerk secret numbers for clerk or cashier assignment, the clerk buttons are not functional.

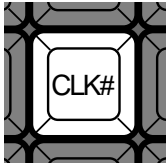

### Clerk button

You can assign the clerk or cashier using the six buttons located below the display panel.

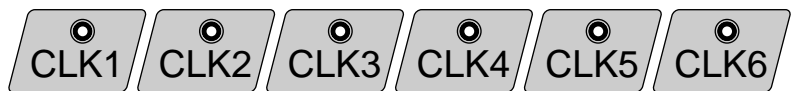

## Drawer

The drawer opens automatically whenever you finalize a registration and whenever you issue a read or reset report.

### Drawer lock (for medium size drawer)

Use the drawer key to lock and unlock the drawer.

### Drawer open key (for large size drawer)

Use the drawer open key to open the drawer.

### When the cash drawer does not open! (for medium size drawer only)

In case of power failure or the machine is in malfunction, the cash drawer does not open automatically. Even in these cases, you can open the cash drawer by pulling drawer release lever (see below).

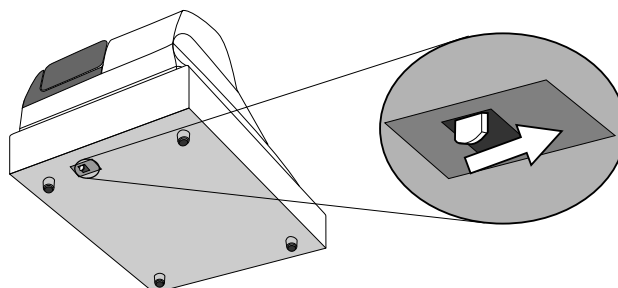

#### Important!

The drawer will not open, if it is locked with a drawer lock key.

# Introducing TE-4000F/4500F

## Display

### Display panel

#### Main display



#### Customer display

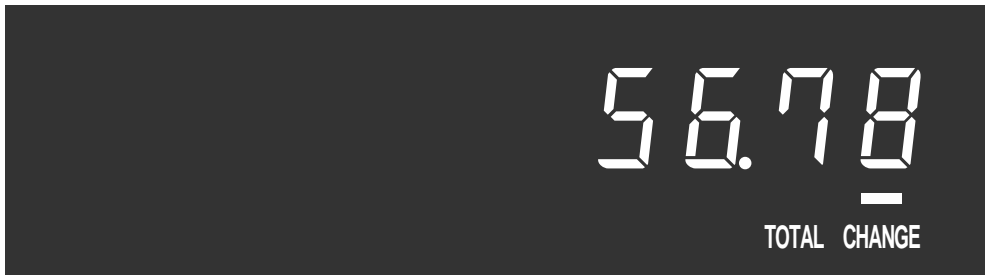

#### Contrast control knob

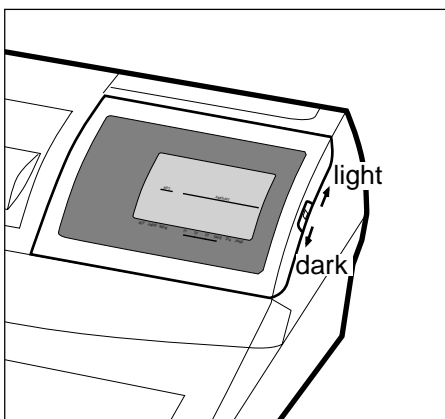

#### Tilt the LCD

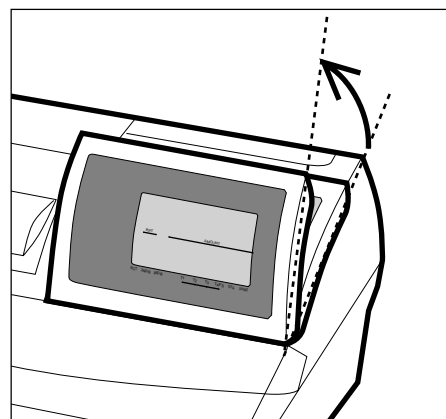

#### Backlight color control switch

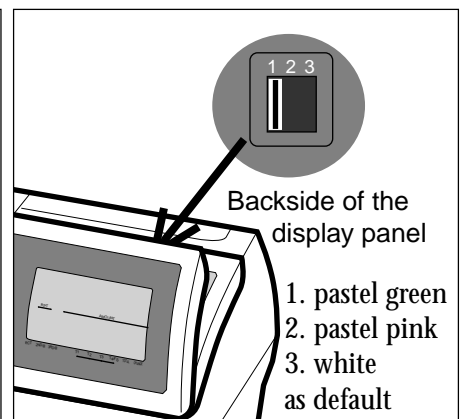

## Display example

### Item registration

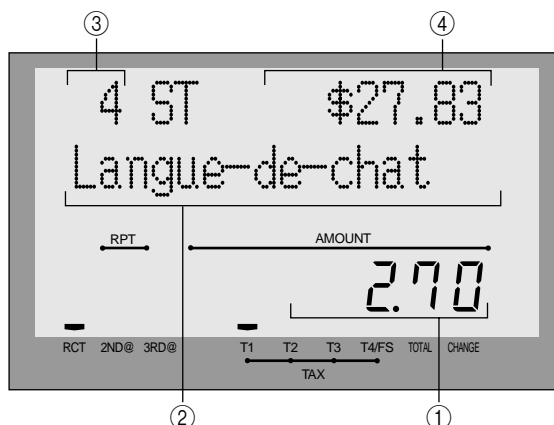

- ① **Amount/Quantity**  
This part of the display shows monetary amounts. It also can be used to show the current time.
- ② **Item descriptor**  
When you register a department/PLU/scanning PLU, the item descriptor appears here.
- ③ **Item counter**  
Number of item sold is displayed.
- ④ **Subtotal amount**  
Current subtotal amount (add-on tax excluded) is displayed.

### Repeat registration



- ⑤ **Number of repeats**  
Anytime you perform a repeat registration (pages 34, 39), the number of repeats appears here. Note that only one digit is displayed for the number of repeats. This means that a “5” could mean 5, 15 or even 25 repeats.
- ⑥ **2nd, 3rd menu indicator**  
When you press PRICE SHIFT to designate the 2nd/3rd unit price, the corresponding number is displayed.

### Totalize operation

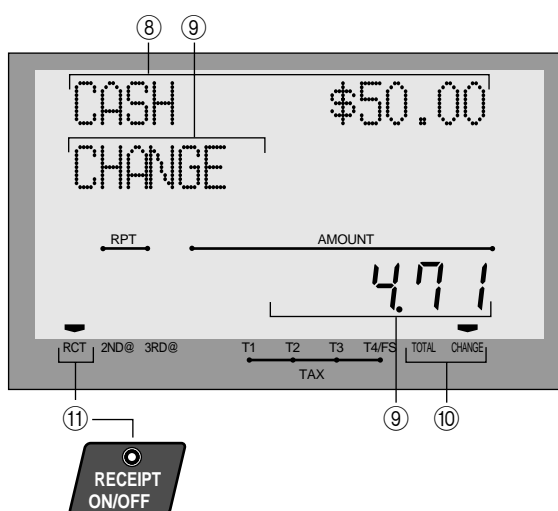

- ⑦ **Taxable sales status indicators**  
When you register a taxable item, the corresponding indicator is lit.
- ⑧ **Amount tendered key descriptor/amount**
- ⑨ **Change descriptor/amount**
- ⑩ **Total/Change indicators**  
When the TOTAL indicator is lit, the displayed value is monetary total or subtotal amount. When the CHANGE indicator is lit, the displayed value is the change due.
- ⑪ **RCT indicator**  
When the register issues receipts, this indicator is lit.

# Introducing TE-4000F/4500F

## Keyboard (TE-4000F)

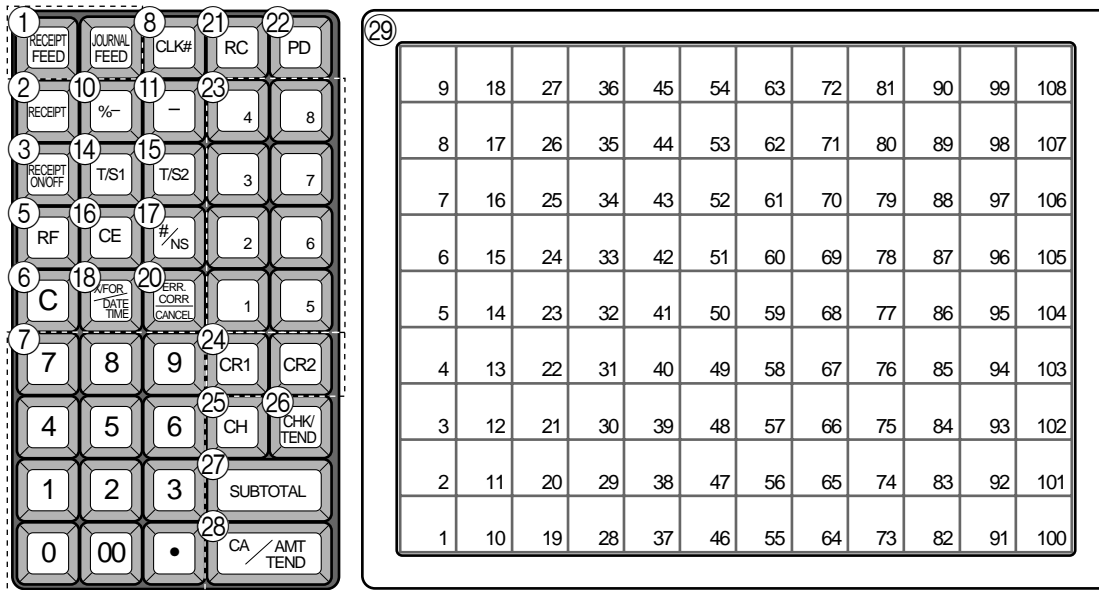

for the U.S.

### • Register Mode

- ① **Paper feed key** RECEIPT FEED, JOURNAL FEED  
Hold this key down to feed paper from the printer.
- ② **Post receipt key** RECEIPT  
Use this key to produce a post-finalization receipt.
- ③ **Receipt on/off key** RECEIPT ON/OFF  
Use this key twice to change the status “receipt issue” or “no receipt.” In case of “receipt issue”, the indicator is lit.
- ④ **Open key** OPEN  
Use this key to temporarily release a limitation on the number of digits that can be input for a unit price.
- ⑤ **Refund key** RF  
Use this key to input refund amounts and void certain entries.
- ⑥ **Clear key** C  
Use this key to clear an entry that has not yet been registered.
- ⑦ **Ten key pad** 0, 1 ~ 9, 00, .  
Use these keys to input numbers.
- ⑧ **Clerk number key** CLK#  
Use this key to sign clerk on and off the register.
- ⑨ **VAT key** VAT  
Use this key to print a VAT breakdown.
- ⑩ **Discount key** %-  
Use this key to register discounts.
- ⑪ **Minus key** -  
Use this key to input values for subtraction.
- ⑫ **Loan key** LOAN  
This key is used to input the amount of money provided for making change. This operation affects media totals, rather than sales totals. Loans are made for all types of money which can be specified by the finalize key.
- ⑬ **Pick up key** PICK UP  
When the amount in drawer exceeds the limit value (sentinel function), the manager performs a pick up operation. This key is used for this function. This operation affects media totals, rather than sales totals. Pick ups are made for all types of money which can be specified by the finalize key.
- ⑭ **Tax status shift 1 key** T/S1  
Use this key to change the Taxable 1 status of the next item.
- ⑮ **Tax status shift 2 key** T/S2  
Use this key to change the Taxable 2 status of the next item.
- ⑯ **Currency exchange** CE  
Use this key to convert foreign currency to local currency or vice versa using the exchange rate preset for the key and displays the result.  
Use this key for conversions of a home currency subtotal or merchandise subtotal to equivalent of another country's currency.  
Use this key for conversions of another country's currency to the equivalent of the home currency.

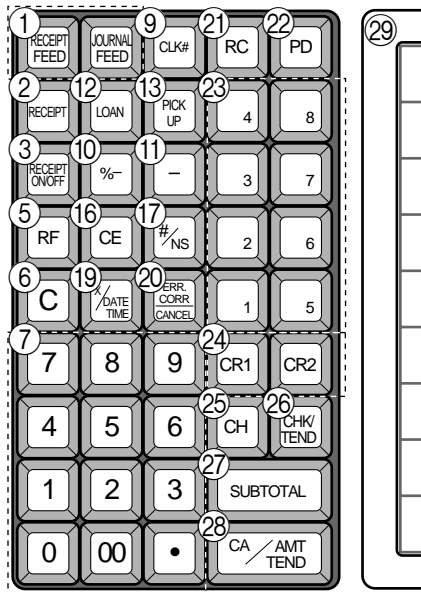

for German

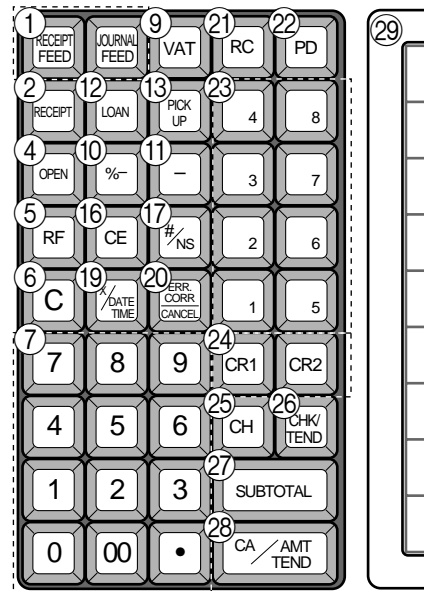

for other area

- 17 Non-add/No sale key** #/NS

Non-add key: To print reference number (to identify a personal check, credit card, etc.) during a transaction, use this key after some numerical entries.

No sale key: Use this key to open the drawer without registering anything.
- 18 Multiplication/For/Date/Time key** X / FOR  
/ DATE  
/ TIME

Use this key to input a quantity for a multiplication operation and registration of split sales of packaged items. Between transactions, this key displays the current time and date.
- 19 Multiplication/Date/Time key** X / DATE  
/ TIME

Use this key to input a quantity for a multiplication operation. Between transactions, this key displays the current time and date.
- 20 Error correction/Cancellation key** ERR CORR  
CANCEL

Use this key to correct registration errors and to cancel registration of entire transactions.
- 21 Received on account key** RC

Use this key following a numeric entry to register money received for non-sale transactions.
- 22 Paid out key** PD

Use this key following a numeric entry to register money paid out from the drawer.

Except for the U.S. and Canada, use this key to convert the main currency to the sub currency (the euro/the local money), when registering a subtotal amount. This key is also used for specifying sub currency while entering an amount of payment or declaration in drawers.
- 23 Department keys** 1, 2, 3 ~ 8

Use these keys to register items to departments.
- 24 Credit key** CR1, CR2

Use this key to register a credit sale.
- 25 Charge key** CH

Use this key to register a charge sale.
- 26 Check key** CHK/  
TEND

Use this key to register a check tender.
- 27 Subtotal key** SUB  
TOTAL

Use this key to display and print the current subtotal (includes add-on tax) amount.
- 28 Cash/Amount tendered key** CA/AMT  
TEND

Use this key to register a cash tender.
- 29 Flat PLU key** 001, 002 ~ 108

Use these keys to register items to flat PLUs.





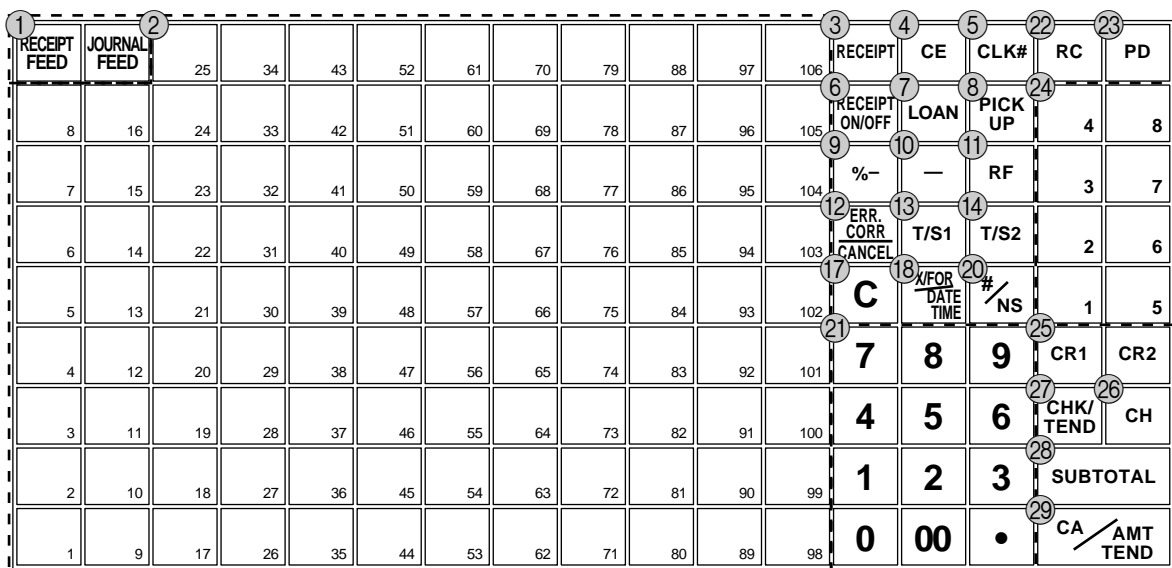













# Introducing TE-4000F/4500F

## Keyboard (TE-4500F)



for the U.S./Canada

### • Register Mode

- ① **Paper feed key** ,   
Hold this key down to feed paper from the printer.
- ② **Flat PLU key** ,  ~   
Use these keys to register items to flat PLUs.
- ③ **Post receipt key**   
Press this key to produce a post-finalization receipt.
- ④ **Currency exchange**   
Use this key to convert foreign currency to local currency or vice versa using the exchange rate preset for the key and displays the result.  
Use this key for conversions of a home currency subtotal or merchandise subtotal to equivalent of another country's currency.  
Use this key for conversions of another country's currency to the equivalent of the home currency.
- ⑤ **Clerk number key**   
Use this key to sign clerk on and off the register.
- ⑥ **Receipt on/off key**   
Use this key twice to change the status "receipt issue" or "no receipt." In case of "receipt issue", the indicator is lit.
- ⑦ **Loan key**   
This key is used to input the amount of money provided for making change. This operation affects media totals, rather than sales totals. Loans are made for all types of money which can be specified by the finalize key.
- ⑧ **Pick up key**   
When the amount in drawer exceeds the limit value (sentinel function), the manager performs a pick up operation. This key is used for this function. This operation affects media totals, rather than sales totals. Pick ups are made for all types of money which can be specified by the finalize key.
- ⑨ **Discount key**   
Use this key to register discounts.
- ⑩ **Minus key**   
Use this key to input values for subtraction.
- ⑪ **Refund key**   
Use this key to input refund amounts and void certain entries.
- ⑫ **Error correction/Cancellation key**   
Use this key to correct registration errors and to cancel registration of entire transactions.
- ⑬ **Tax status shift 1 key**   
Use this key to change the Taxable 1 status of the next item.
- ⑭ **Tax status shift 2 key**   
Use this key to change the Taxable 2 status of the next item.
- ⑮ **Open key**   
Use this key to temporarily release a limitation on the number of digits that can be input for a unit price.
- ⑯ **VAT key**   
Use this key to print a VAT breakdown.



1	RECEIPT FEED	2	JOURNAL FEED	25	34	43	52	61	70	79	88	97	106	3	RECEIPT	4	CE	5	CLK#	22	RC	23	PD																																																																																															
8	16	24	33	42	51	60	69	78	87	96	105	104	103	102	101	100	99	98	6	RECEIPT ON/OFF	7	LOAN	8	PICK UP	4	8																																																																																												
7	15	23	32	41	50	59	68	77	86	95	104	103	102	101	100	99	98	97	96	95	94	93	92	91	90	89	88	87	86	85	84	83	82	81	80	79	78	77	76	75	74	73	72	71	70	69	68	67	66	65	64	63	62	61	60	59	58	57	56	55	54	53	52	51	50	49	48	47	46	45	44	43	42	41	40	39	38	37	36	35	34	33	32	31	30	29	28	27	26	25	24	23	22	21	20	19	18	17	16	15	14	13	12	11	10	9	8	7	6	5	4	3	2	1	0	00	.	CA / AMT TEND
6	14	22	31	40	49	58	67	76	85	94	103	102	101	100	99	98	97	96	95	94	93	92	91	90	89	88	87	86	85	84	83	82	81	80	79	78	77	76	75	74	73	72	71	70	69	68	67	66	65	64	63	62	61	60	59	58	57	56	55	54	53	52	51	50	49	48	47	46	45	44	43	42	41	40	39	38	37	36	35	34	33	32	31	30	29	28	27	26	25	24	23	22	21	20	19	18	17	16	15	14	13	12	11	10	9	8	7	6	5	4	3	2	1	0	00	.	CA / AMT TEND	
5	13	21	30	39	48	57	66	75	84	93	102	101	100	99	98	97	96	95	94	93	92	91	90	89	88	87	86	85	84	83	82	81	80	79	78	77	76	75	74	73	72	71	70	69	68	67	66	65	64	63	62	61	60	59	58	57	56	55	54	53	52	51	50	49	48	47	46	45	44	43	42	41	40	39	38	37	36	35	34	33	32	31	30	29	28	27	26	25	24	23	22	21	20	19	18	17	16	15	14	13	12	11	10	9	8	7	6	5	4	3	2	1	0	00	.	CA / AMT TEND		
4	12	20	29	38	47	56	65	74	83	92	101	100	99	98	97	96	95	94	93	92	91	90	89	88	87	86	85	84	83	82	81	80	79	78	77	76	75	74	73	72	71	70	69	68	67	66	65	64	63	62	61	60	59	58	57	56	55	54	53	52	51	50	49	48	47	46	45	44	43	42	41	40	39	38	37	36	35	34	33	32	31	30	29	28	27	26	25	24	23	22	21	20	19	18	17	16	15	14	13	12	11	10	9	8	7	6	5	4	3	2	1	0	00	.	CA / AMT TEND			
3	11	19	28	37	46	55	64	73	82	91	100	99	98	97	96	95	94	93	92	91	90	89	88	87	86	85	84	83	82	81	80	79	78	77	76	75	74	73	72	71	70	69	68	67	66	65	64	63	62	61	60	59	58	57	56	55	54	53	52	51	50	49	48	47	46	45	44	43	42	41	40	39	38	37	36	35	34	33	32	31	30	29	28	27	26	25	24	23	22	21	20	19	18	17	16	15	14	13	12	11	10	9	8	7	6	5	4	3	2	1	0	00	.	CA / AMT TEND				
2	10	18	27	36	45	54	63	72	81	90	99	98	97	96	95	94	93	92	91	90	89	88	87	86	85	84	83	82	81	80	79	78	77	76	75	74	73	72	71	70	69	68	67	66	65	64	63	62	61	60	59	58	57	56	55	54	53	52	51	50	49	48	47	46	45	44	43	42	41	40	39	38	37	36	35	34	33	32	31	30	29	28	27	26	25	24	23	22	21	20	19	18	17	16	15	14	13	12	11	10	9	8	7	6	5	4	3	2	1	0	00	.	CA / AMT TEND					
1	9	17	26	35	44	53	62	71	80	89	98	97	96	95	94	93	92	91	90	89	88	87	86	85	84	83	82	81	80	79	78	77	76	75	74	73	72	71	70	69	68	67	66	65	64	63	62	61	60	59	58	57	56	55	54	53	52	51	50	49	48	47	46	45	44	43	42	41	40	39	38	37	36	35	34	33	32	31	30	29	28	27	26	25	24	23	22	21	20	19	18	17	16	15	14	13	12	11	10	9	8	7	6	5	4	3	2	1	0	00	.	CA / AMT TEND						

for U.K.

- 17 **Clear key** **C**  
Use this key to clear an entry that has not yet been registered.
- 18 **Multiplication/For/Date/Time key** **X / FOR DATE TIME**  
Use this key to input a quantity for a multiplication operation and registration of split sales of packaged items. Between transactions, this key displays the current time and date.
- 19 **Multiplication/Date/Time key** **X / DATE TIME**  
Use this key to input a quantity for a multiplication operation. Between transactions, this key displays the current time and date.
- 20 **Non-add/No sale key** **# / NS**  
Non-add key: To print reference number (to identify a personal check, credit card, etc.) during a transaction, use this key after some numerical entries.  
No sale key: Use this key to open the drawer without registering anything.
- 21 **Ten key pad** **0, 1 ~ 9, 00, .**  
Use these keys to input numbers.
- 22 **Received on account key** **RC**  
Use this key following a numeric entry to register money received for non-sale transactions.
- 23 **Paid out key** **PD**  
Use this key following a numeric entry to register money paid out from the drawer.  
Except for the U.S. and Canada, use this key to convert the main currency to the sub currency (the euro/the local money), when registering a subtotal amount. This key is also used for specifying sub currency while entering an amount of payment or declaration in drawers.
- 24 **Department keys** **1, 2, 3 ~ 8**  
Use these keys to register items to departments.
- 25 **Credit key** **CR1, CR2**  
Use this key to register a credit sale.
- 26 **Charge key** **CH**  
Use this key to register a charge sale.
- 27 **Check key** **CHK / TEND**  
Use this key to register a check tender.
- 28 **Subtotal key** **SUB TOTAL**  
Use this key to display and print the current subtotal (includes add-on tax) amount.
- 29 **Cash/Amount tendered key** **CA / AMT TEND**  
Use this key to register a cash tender.

## Allocatable functions

You can tailor a keyboard to suit your particular type of business.

### Add check

Use this key in a check tracking system to combine the details of more than one check into a single check.

### Arrangement

Use this key to activate an arrangement program programmed in the arrangement file. Any operation that can be performed from the keyboard, as well as mode, can be programmed in an arrangement program, and can be performed merely by pressing this key. In addition, one numeric entry can be included in an arrangement program. In this case, input the number and press this key.

The mode control function of this key can be programmed for all modes except for the OFF and PGM mode.

### Bill copy

Use this key to issue bill copy.

### Bottle return

Use this key to specify next item as bottle return.

### Cancel

Invalidates all preceding data registered for departments, PLUs and set menus within a transaction. This key must be pressed before the transaction involving the data to be invalidated is finalized. It is also effective even after calculation of subtotal amount.

### Check endorsement

Use this key to print a preset check endorsement message using the slip printer.

### Check print

Use this key to print the check on the slip printer.

### Clerk transfer

Use this key to transfer opened checks to another clerk.

### Clock-in/-out

Use this key to register the time when the employees start/finish their job.

### Coupon

Use this key for registering coupons.

### Coupon 2

Use this key to declare the next item registration as coupon.

### Cube

This key provides the same functions as the Square key. In addition, this key also has a cube multiplication function.

### Customer number

Use this key to register the number of customers.

### Declaration

Use this key to declare in drawer amount for money declaration.

### Deposit

Use this key to register deposits.

### Eat-in

Use this key to specify if the customer eats in the restaurant. Before closing a transaction press this key.

### EBT (electronic benefit transfer)

Use this key to register an EBT amount with a tender amount input.

### Food stamp shift

Use this key to change food stamp status.

### Food stamp subtotal

Use this key to obtain the food stamp applicable amount.

### Food stamp tender

Use this key to register a food stamp payment amount with a tender amount input.

### Ketten Bon

Use this key to enter quantities for multiplication. Multiplication by this key issues singular order prints.

### Manual tax

Use this key to register a tax amount.

### Media change

Use this key to change media in drawer amount. Pressing this key enters media change operation.

### Menu shift

Use this key to shift key to the 1st ~ 6th menu.

### Merchandise subtotal

Use this key to obtain subtotal excluding the add-on tax amount and the previous balance.

### New balance

Use this key for adding the latest registered total amount to the previous balance to obtain a new balance.

### New check

Use this key in a check tracking system to input a new check number in order to open a new check under that number.

### New/Old check

Use this key in a check tracking system to input check numbers in order to open new checks and to reopen existing checks. When the clerk inputs a check number, the register checks to see if that number already exists in the check tracking memory. If there is no matching number in the memory, a new check is opened under the input number. If the check number input matches a number already stored in the memory, that check is reopened for further registration or finalization.

### No sale

Use this key to open the drawer between transaction.

### Non add

Use this key to print reference numbers (personal check number, card number, etc.)

### Normal receipt

Use this key to change the order status from Bon to normal.

### OBR (Optical barcode reader)

Use this key to input optical barcodes manually.

### Old check

Use this key in a check tracking system to input the number of an existing check (previously created by the New check key) whose details are stored in the check tracking memory. Existing checks are reopened to perform further registration or to finalize them.

### One touch NLU

Use this key to register scanning PLU directly from the keyboard. There is one One touch NLU key for one scanning PLU, and multiple one touch NLU keys can be set on the keyboard.

### Open 2

Use this key to suspend the compulsory specifications.

**Open check**

Use this key to issue an open check report of an assigned clerk.

**Operator number**

Use this key to enter a clerk number during clerk transfer.

**Operator X/Z**

Use this key to issue a clerk's individual X/Z report.

**Plus**

Use this key for registering surcharge.

**Premium**

Use this key to apply a preset % or manual input % to obtain the premium amount for the last registered item or subtotal.

**Previous balance**

Use this key to register the previous negative/positive balance at the beginning of or during a transaction.

**Previous balance subtotal**

Use this key to obtain subtotal excluding the add-on tax amount and current balance.

**Price**

Use this key to register an open PLU.

**Price change**

Use this key to change scanning PLU unit price temporarily.

**Price inquiry**

Use this key to confirm the price and descriptors of PLU without registering.

**Price shift**

Use this key to shift a PLU item/flat-PLU key to the 1st ~ 2nd unit price, a scanning PLU to the 1st ~ 3rd unit price.

**Rate tax**

Use this key to activate the preset tax rate or manually input rate to obtain the tax for the preceding taxable status 1 amount.

**Recall**

Use this key for recalling the transferred check number by the store key. When this key is pressed, the check number will appear in order of the oldest record.

**Red price**

Use this key to register a new (discounted) price of an item.

**Review**

Use this key to examine the current transaction by displaying item descriptor and registered amount. This key is also used for void operation or separate check operation.

**Scale**

Use this key to read the weight of the item and shows it on the display. This key is also used to input the weight manually.

**Separate check**

Use this key in a check tracking system to separate selected items from one check to another check.

**Slip feed/release**

Use this key to feed slips inserted into the slip printer. This is done by specifying the number of feed lines. This key is also used to release the slip paper holder if numbers are not entered.

**Slip back feed/release**

Use this key to back feed slips inserted into the slip printer. This is done by specifying the number of feed lines. This key is also used to release the slip paper holder if numbers are not entered.

**Slip print**

Use this key to execute a slip batch printing on the slip printer. Pressing this key prints the sales details. Actual printing is performed following receipt issuance.

**Square**

This key provides the same functions as the Multiplication key. In addition, this key also has a square multiplication function.

**Stock inquiry**

Use this key to check the current stock quantity for a PLU without registering.

**Store**

Use this key for storing the check number of the registered items. When this key is pressed, registered item data will be stored, and then these data will transfer to the youngest check number.

**Table number**

Use this key to input table numbers.

**Table transfer**

Use this key to transfer the contents of a check to another check.

**Takeout**

Use this key to specify if the customer takes out items. Before total a transaction. Press this key for the tax exemption.

**Tare**

Use this key to input tare weight.

**Tax exempt**

Use this key to change taxable amounts to nontaxable amounts.

**Taxable amount subtotal**

Use this key to obtain taxable amount subtotal.

**Text print**

Use this key to enter characters to print.

**Text recall**

Use this key to print preset characters.

**Tip**

Use this key to register tips.

**Tray total**

Use this key to display the total amount for all registrations from the last registration until this key is pressed or registrations between presses of this key.

**Unit weight**

Use this key to input the unit weight of a scalable item.

**Validation**

Use this key to validate transaction amounts on slip.

**Void**

Use this key to invalidate preceding item data registered.

# Introducing TE-4000F/4500F

---

## How to remove/replace the sheet holder (TE-4000F only)

### Remove the sheet holder

Follow steps 1 ~ 2.

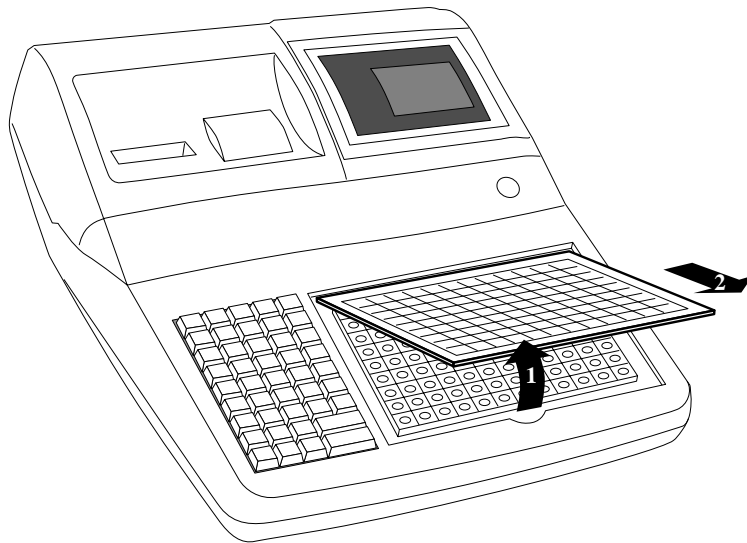

### Replace the sheet holder

Follow steps 3 ~ 4.

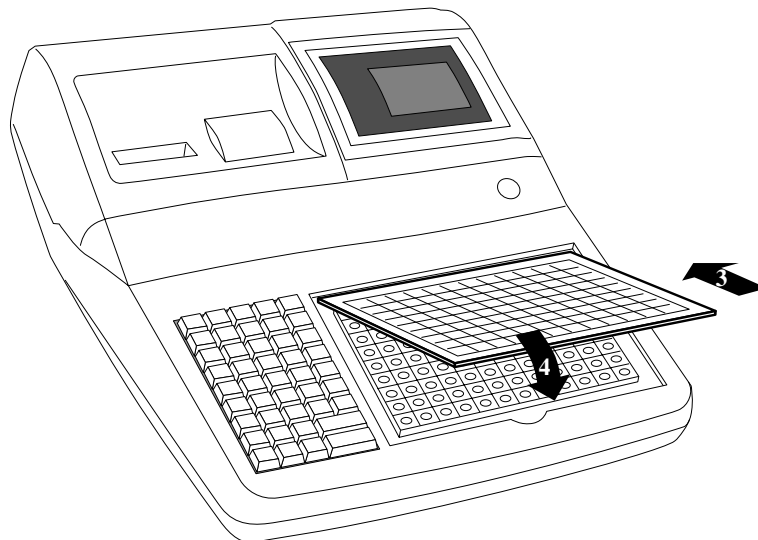

## How to install a menu sheet in the sheet holder (TE-4000F only)

### Open the sheet holder

Follow the steps 1 ~ 3.

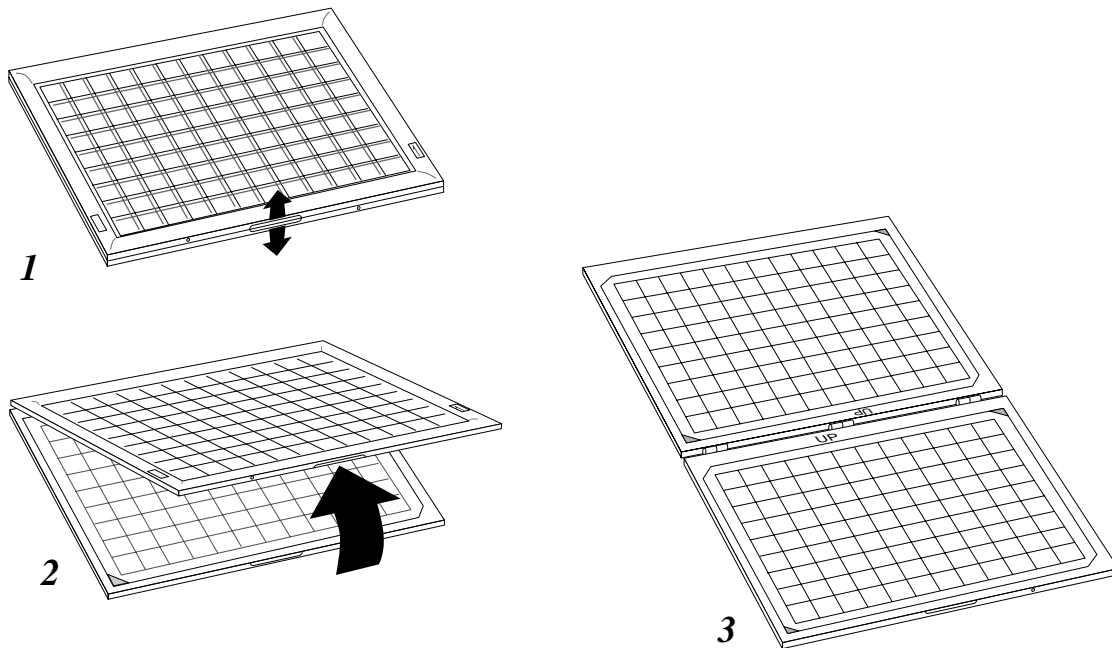

### Set a menu sheet in the sheet holder

Follow the steps 4 ~ 6.

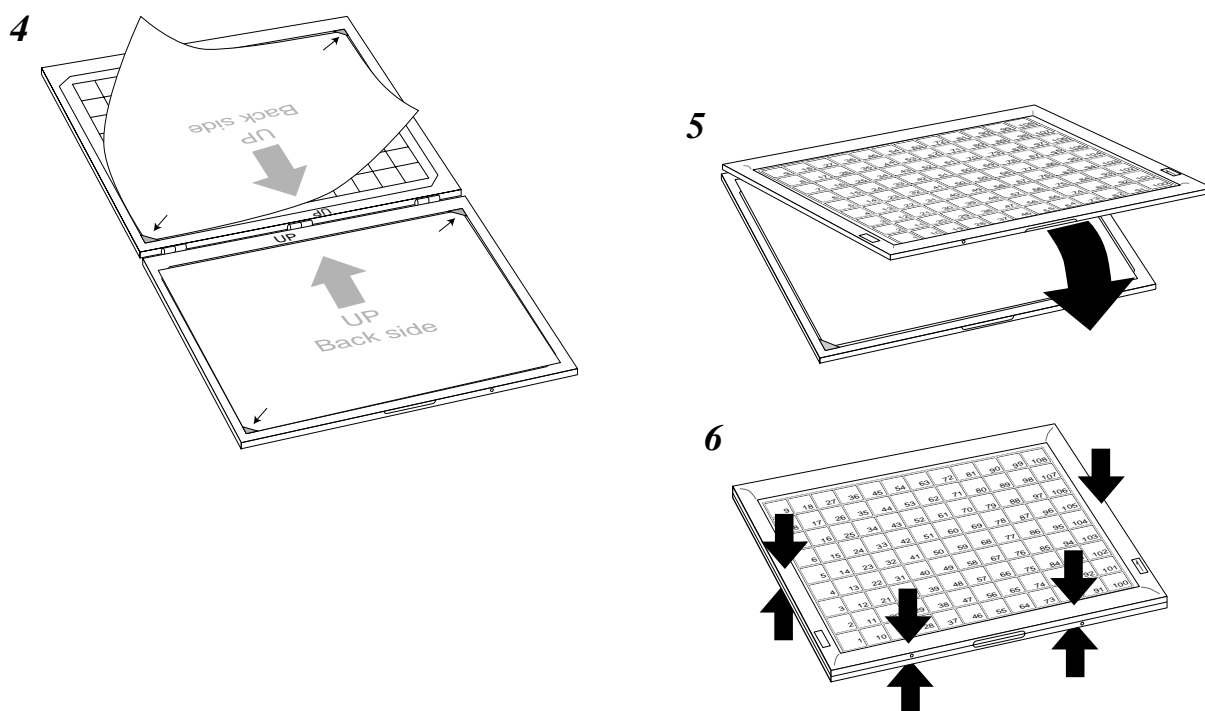

## How to read the printouts

- The journal and receipts are records of all transactions and operations.
- The contents printed on receipts and journal are almost identical.
- You can choose the journal skip function.

If the journal skip function is selected, the cash register will print the total amount of each transaction, and the details of premium, discount and reduction operations only, without printing department and PLU item registrations on the journal.

- The following items can be skipped on receipts and journal.
  - Consecutive number
  - Taxable status
  - Taxable amount
  - Item counter

**Receipt Sample**

***** * THANK YOU * ** CALL AGAIN ** *****	Logo message
* COMMERCIAL MESSAGE * * COMMERCIAL MESSAGE * * COMMERCIAL MESSAGE * * COMMERCIAL MESSAGE *	Commercial message
REG 03-06-2000(SAT) 11:58 C01 MC#01 000123	Mode/Date/Time Clerk/Machine No. Consecutive No.
1 DEPT01 T1 -1.00 1 DEPT02 T1 -2.00 5 DEPT03 -5.00	Q'ty/Item
7 No	Item counter
TA1 -3.00 TX1 -0.15 TL -8.15 CASH -10.00 CG -1.85	
*** BOTTOM MESSAGE *** *** BOTTOM MESSAGE *** *** BOTTOM MESSAGE *** *** BOTTOM MESSAGE ***	Bottom message

**Journal Sample  
(Item lines Included)**

REG 03-06-2000(SAT) 11:58 C01 MC#01 000123
1 DEPT01 T1 -1.00 1 DEPT02 T1 -2.00 5 DEPT03 -5.00
7 No
TA1 -3.00 TX1 -0.15 TL -8.15 CASH -10.00 CG -1.85
REG 03-06-2000(SAT) 11:59 C01 MC#01 000124
1 DEPT01 T1 -1.00 1 DEPT12 T1 -1.00 5 DEPT03 -6.00
7 No
TA1 -2.00 TX1 -0.10 TL -8.10 CASH -10.00 CG -1.90
REG 03-06-2000(SAT) 11:59 C01 MC#01 000124

**Journal Sample  
(Item lines Skipped)**

REG 03-06-2000(SAT) 11:58 C01 MC#01 000123
1 DEPT01 T1 -1.00 1 DEPT02 T1 -2.00 5 DEPT03 -5.00
7 No
TA1 -3.00 TX1 -0.15 TL -8.15 CASH -10.00 CG -1.85
REG 03-06-2000(SAT) 11:59 C01 MC#01 000124
1 DEPT01 T1 -1.00 1 DEPT12 T1 -1.00 5 DEPT03 -6.00
7 No
TA1 -2.00 TX1 -0.10 TL -8.10 CASH -10.00 CG -1.90
REG 03-06-2000(SAT) 11:59 C01 MC#01 000125

In the operation examples contained in this manual, the print samples are what would be produced if the roll paper is being used for receipts. They are not actual size. Actual receipts are 58 mm wide. Also, all sample receipts and journals are printout images.

---

# How to use your cash register

The following describes the general procedure you should use in order to get the most out of your cash register.

## BEFORE business hours...

---

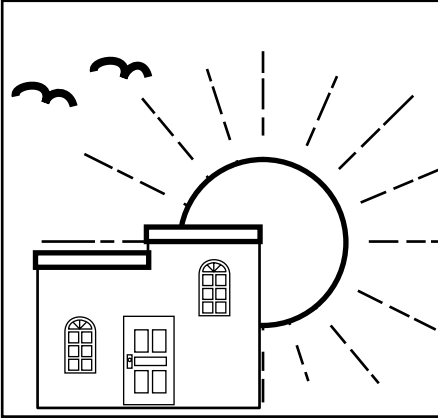

- Check to make sure that the cash register is plugged in securely. Page 11
- Check to make sure there is enough paper left on the roll. Pages 13, 14
- Read the financial totals to confirm that they are all zero. Page 103
- Check the date and time. Page 33

## DURING business hours...

---

- Register transactions. Page 34
- Periodically read totals. Page 102

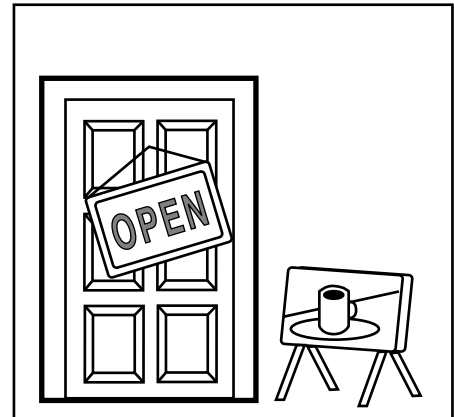

## AFTER business hours...

---

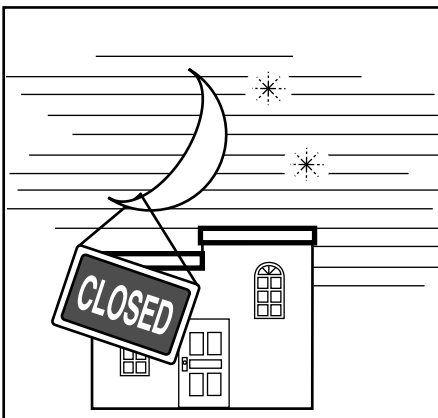

- Reset the daily totals. Page 54
- Remove the journal. Page 118
- Empty the cash drawer and leave it open. Page 19
- Take the cash and journal to the office.

# Basic Operations and Setups

## Assigning a clerk



On models available in the United States and Canada, clerk or cashier assignment can be performed using clerk secret numbers only (clerk buttons are not equipped). In Germany, you can assign clerks by using clerk key or by clerk secret number (clerk key is equipped). In other areas, you can assign clerks by using clerk button or by clerk secret number. The method you of assigning clerk depends on the programming of your cash register.

## Clerk button

You can assign the clerk or cashier using the six buttons located below the display panel.

## Clerk lock/clerk key

You can assign the clerk or cashier inserting a clerk key into the clerk lock .

## Clerk secret number key

When the cash register is programmed to use clerk secret numbers for clerk or cashier assignment, the clerk buttons are not functional.

### Clerk sign on

	OPERATION	RECEIPT
Signing clerk 1 on:	<b>1</b> → <input type="button" value="CLK#"/>	
Signing clerk 2 on:	<b>2</b> → <input type="button" value="CLK#"/>	
...	...	
Signing clerk 15 on:	<b>1 5</b> → <input type="button" value="CLK#"/> Clerk secret number (1 ~ 15 is set as default.)	

- If you do not want the clerk secret number to be shown on the display, press  before entering the number.

### Clerk sign off

	OPERATION
Signing clerk off: (except PGM mode)	<b>0</b> → <input type="button" value="CLK#"/>

- The current clerk is also signed off whenever you set the mode switch to OFF position.

## Important!

- The error code “E008” appears on the display whenever you try to perform a registration, a read/ reset operation without signing on.
- A clerk cannot sign on unless other clerk is signed off.
- The signed on clerk is also identified on the receipt/journal.





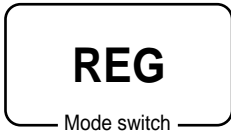

## Displaying the time and date

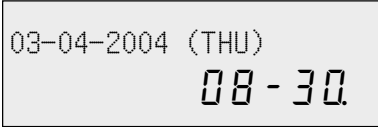

You can show the time or date on the display of the cash register whenever there is no registration being made.

### To display and clear the date/time



OPERATION	DISPLAY
 or  <p>Date/time appears on the display.</p>	 <p>03-04-2004 (THU) 08-30</p>
 <p>Clears the date/time display.</p>	 <p>REG 01 0.00</p>

## Preparing coins for change



You can use the following procedure to open the drawer without registering an item. This operation must be performed out of a sale. (You can use the **RC** key instead of the **#/NS** key. See page 49.)

### Opening the drawer without a sale

OPERATION	RECEIPT
	 <p>#/NS                   .....</p>

## Preparing and using department/flat-PLU keys

### Registering department/flat-PLU keys



The following examples show how you can use the department/flat-PLU keys in various types of registrations.

### Single item sale

#### Example 1

#### OPERATION

#### RECEIPT

Item	Unit price	\$1.00
	Quantity	1
	Dept.	1
Payment	Cash	\$1.00

**1 00**  
Unit price

1 DEPT01	.1.00	Department No./ unit price Total amount
TL	- 1.00	
CASH	.1.00	

**1**

Department

CA/AMT  
TEND

#### Example 2 (Subtotal registration and change computation)

#### OPERATION

#### RECEIPT

Item	Unit price	\$12.34
	Quantity	1
	Flat-PLU	1
Payment	Cash	\$20.00

**1 2 3 4**

Unit price

**001**

Flat-PLU

SUB  
TOTAL

1 PLU001	.12.34	Total amount Amount tendered Change
TL	- 12.34	
CASH	.20.00	
CG	.7.66	

**2 0 00** CA/AMT  
TEND

Amount tendered

### Repeat

#### OPERATION

#### RECEIPT

Item	Unit price	\$1.50
	Quantity	3
	Dept.	1
Payment	Cash	\$10.00

**1 5 0 1**

**1**

**1**

SUB  
TOTAL

1 DEPT01	.1.50	Repeat
1 DEPT01	.1.50	
1 DEPT01	.1.50	Repeat
TL	- 4.50	
CASH	.10.00	
CG	.5.50	

**1 0 00** CA/AMT  
TEND

## Multiplication

Item	Unit price	\$1.00
	Quantity	12
	Flat-PLU	1
Payment	Cash	\$20.00

**OPERATION**

**1 2**  /FOR DATE TIME

Quantity  
(4-digit integer/2-digit decimal)

**1 00**  /FOR DATE TIME

**001**  /FOR DATE TIME

**2 0 00**  /FOR DATE TIME

CA/AMT/TEND

**RECEIPT**

12 PLU0001	. 12.00	Quantity/result
12X @1/ 1.00		or
PLU0001	. 12.00	Quantity/unit q'ty/@
		Result
TL	- 12.00	
CASH	. 20.00	
CG	. 8.00	

- The model for the U.S./Canada, use  /FOR DATE TIME instead of  /FOR DATE TIME.

## Split sales of packaged items

Item	Unit price	4 for \$10.00
	Quantity	3
	Dept.	1
	Taxable	No
Payment	Cash	\$10.00

**OPERATION**

**3**  /FOR DATE TIME

Quantity being purchased  
(4-digit integer/2-digit decimal)

**4**  /FOR DATE TIME

Package quantity  
(4-digit integer/2-digit decimal)

**1 0 00**  /FOR DATE TIME

**1**  /FOR DATE TIME

Package price

**1 0 00**  /FOR DATE TIME

CA/AMT/TEND

**RECEIPT**

3 DEPT01	. 7.50	Quantity/result
3X @4/ 10.00		or
DEPT01	. 7.50	Quantity/unit q'ty/@
		Result
TL	- 7.50	
CASH	. 10.00	
CG	. 2.50	

- If  /FOR DATE TIME is not allocated on the keyboard, key allocation is necessary.

## Programming department/flat-PLU keys

To program a unit price for each department/flat-PLU

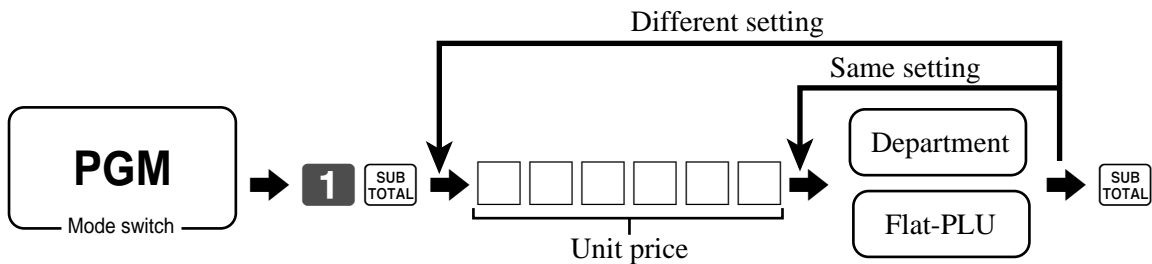

To program the tax calculation status for each department/flat-PLU

### Tax calculation status

This specification defines which tax table should be used for automatic tax calculation.

# Basic Operations and Setups

## Programming procedure

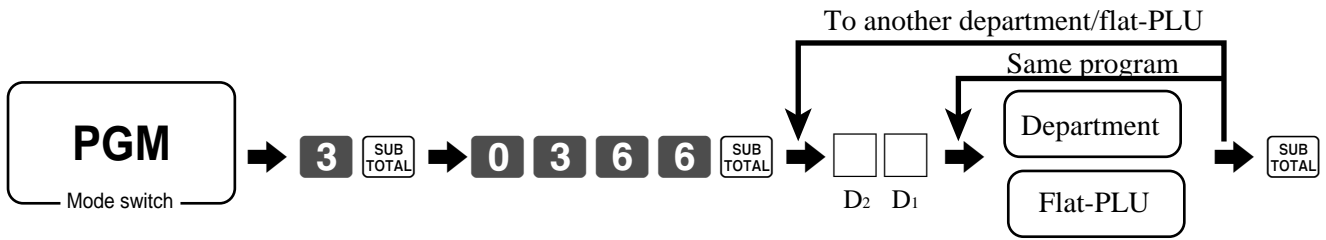

Description	Choice	Program code
-------------	--------	--------------

for the U.S. / Singapore

Food stamp (for Singapore, always "0".)	Yes = 1 No = 0	<input type="checkbox"/> D <sub>2</sub>
Taxable 1 status	a Yes = 1 No = 0	a+b+c <input type="checkbox"/> D <sub>1</sub>
Taxable 2 status	b Yes = 2 No = 0	
Taxable 3 status	c Yes = 4 No = 0	

for Canada

Donuts status	Yes = 1 No = 0	<input type="checkbox"/> D <sub>2</sub>
Non tax = 0 Taxable 1 = 1 Taxable 2 = 2	Taxable 3 = 3 Taxable 4 = 4 Taxable 1 & 2 = 5	Significant number <input type="checkbox"/> D <sub>1</sub>
	Taxable 1 & 3 = 6 Taxable 1 & 4 = 7	

for other area

Non tax = 0 Taxable 1 = 1 Taxable 2 = 2 Taxable 3 = 3	Taxable 4 = 4 Taxable 5 = 5 Taxable 6 = 6 Taxable 7 = 7	Taxable 8 = 8 Taxable 9 = 9 Taxable 10 = 10	Significant numbers <input type="checkbox"/> <input type="checkbox"/> D <sub>2</sub> D <sub>1</sub>
--	--	---	--

## To program high amount limit for each department/flat-PLU

### Programming procedure

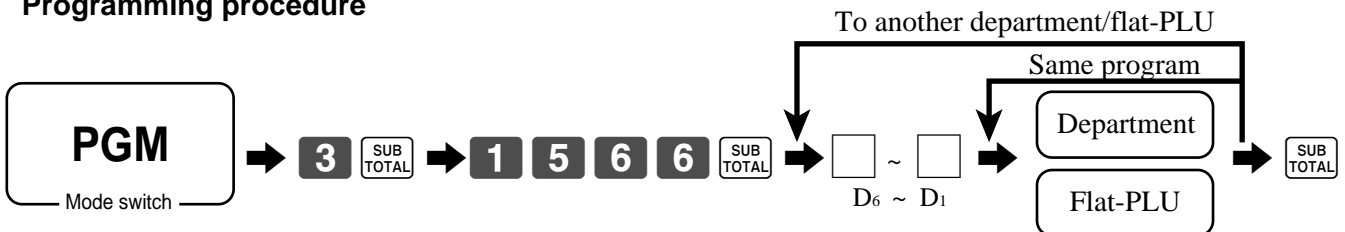

Description	Choice	Program code
High amount limit for entering unit price manually.	Significant numbers	<input type="checkbox"/> ~ <input type="checkbox"/> D <sub>6</sub> ~ D <sub>1</sub>

## Registering department/flat-PLU keys by programming data



### Preset price

Item	Unit price	(\$1.00) <sub>preset</sub>
	Quantity	1
	Dept.	2
Payment	Cash	\$1.00

#### OPERATION

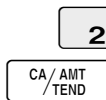

#### RECEIPT

1 DEPT02		. 1.00	Department No./ unit price
TL	- 1.00		
CASH		. 1.00	

### Preset tax status

Item 1	Unit price	(\$2.00) <sub>preset</sub>
	Quantity	5
	Dept.	3
	Taxable	(1) <sub>preset</sub>
Item 2	Unit price	(\$2.00) <sub>preset</sub>
	Quantity	1
	Dept.	4
	Taxable	(2) <sub>preset</sub>
Payment	Cash	\$20.00

#### OPERATION

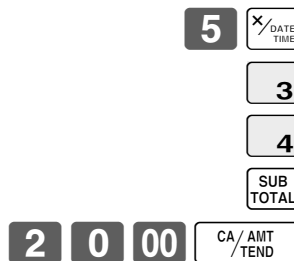

#### RECEIPT

5 DEPT03	T1	. 10.00	Tax status
1 DEPT04	T2	. 2.00	
TA1		. 10.00	Taxable Amount 1
TX1		. 0.40	Tax 1
TA2		. 2.00	Taxable Amount 2
TX2		. 0.20	Tax 2
TL		- 12.60	
CASH		. 20.00	
CG		. 7.40	

- The model for the U.S./Canada, use  FOR DATE TIME instead of  DATE TIME.

### Locking out high amount limitation

Item	Unit price	\$1.05
	Quantity	1
	Dept.	3
	Max.amount	(\$10.00) <sub>preset</sub>
Payment	Cash	\$2.00

#### OPERATION

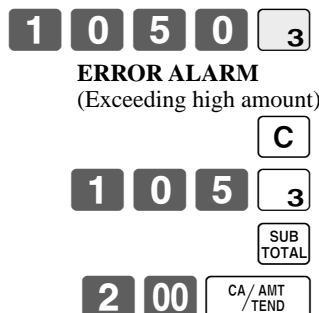

#### RECEIPT

1 DEPT03		. 1.05
TL	- 1.05	
CASH		. 2.00
CG		. 0.95

## Preparing and using PLUs

This section describes how to prepare and use PLUs.

### CAUTION:

Before you use PLUs, you must first program the unit price and tax status.

### Programming PLUs

#### To program a unit price for each PLU

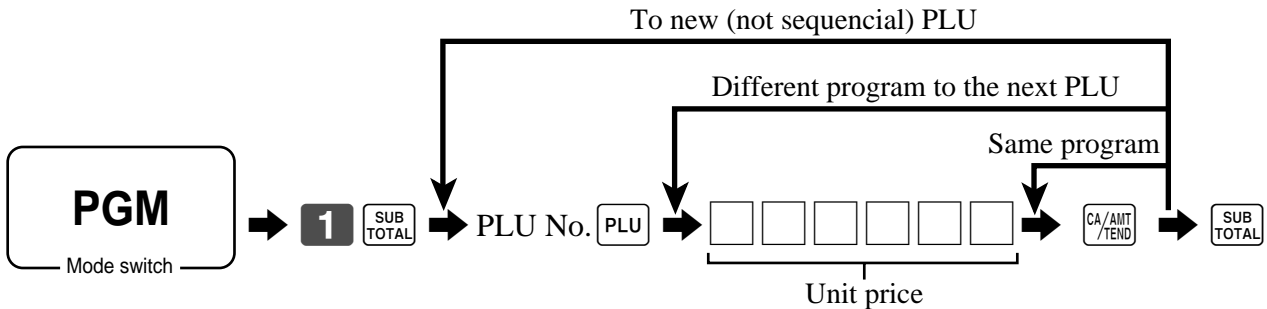

#### To program tax calculation status for each PLU

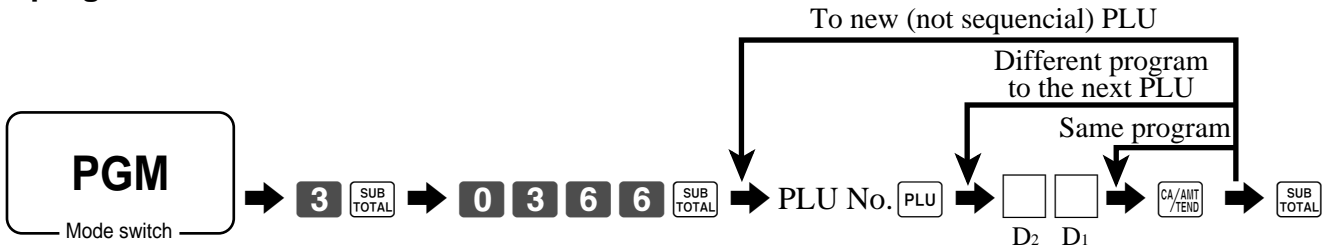

Description	Choice	Program code
-------------	--------	--------------

for the U.S. / Singapore

Food stamp (for Singapore, always "0").	Yes = 1 No = 0	<input type="checkbox"/> D <sub>2</sub>
Taxable 1 status	a Yes = 1 No = 0	a+b+c <input type="checkbox"/> D <sub>1</sub>
Taxable 2 status	b Yes = 2 No = 0	
Taxable 3 status	c Yes = 4 No = 0	

for Canada

Donuts status	Yes = 1 No = 0	<input type="checkbox"/> D <sub>2</sub>
Non tax = 0 Taxable 1 = 1 Taxable 2 = 2	Taxable 3 = 3 Taxable 4 = 4 Taxable 1 & 2 = 5	Significant number <input type="checkbox"/> D <sub>1</sub>
	Taxable 1 & 3 = 6 Taxable 1 & 4 = 7	

for other area

Non tax = 0 Taxable 1 = 1 Taxable 2 = 2 Taxable 3 = 3	Taxable 4 = 4 Taxable 5 = 5 Taxable 6 = 6 Taxable 7 = 7	Taxable 8 = 8 Taxable 9 = 9 Taxable 10 = 10	Significant numbers <input type="checkbox"/> <input type="checkbox"/> D <sub>2</sub> D <sub>1</sub>
--	--	---	---

## Registering PLUs

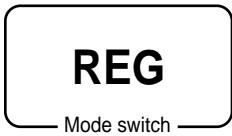

The following examples show how you can use PLUs in various types of registrations.

### PLU single item sale

Item	Unit price	(\$2.50) <sub>preset</sub>
	Quantity	1
	PLU	14
Payment	Cash	\$3.00

#### OPERATION

**1 4**  
PLU code

**PLU**

**SUB TOTAL**

**3 00** CA/AMT/TEND

#### RECEIPT

1 PLU0014	·2.50	PLU No./unit price
TL	- 2.50	
CASH	·3.00	
CG	·0.50	

### PLU repeat

Item	Unit price	(\$2.50) <sub>preset</sub>
	Quantity	3
	PLU	14
Payment	Cash	\$10.00

#### OPERATION

**1 4** **PLU**

**PLU**

**PLU**

**SUB TOTAL**

**1 0 00** CA/AMT/TEND

#### RECEIPT

1 PLU0014	·2.50
1 PLU0014	·2.50
1 PLU0014	·2.50
TL	- 7.50
CASH	·10.00
CG	·2.50

### PLU multiplication

Item	Unit price	(\$2.00) <sub>preset</sub>
	Quantity	10
	PLU	7
Payment	Cash	\$20.00

#### OPERATION

**1 0**  DATE TIME

Quantity  
(4-digit integer/2-digit decimal)

**7** **PLU**

**SUB TOTAL**

**2 0 00** CA/AMT/TEND

#### RECEIPT

10 PLU0007	·20.00	Quantity/result or Quantity/unit q'ty/@ Result
10X @1/ 2.00		
PLU0007	·20.00	
TL	- 20.00	
CASH	·20.00	
CG	·0.00	

- The model for the U.S./Canada, use  FOR DATE TIME instead of  DATE TIME.

# Basic Operations and Setups

## Split sales of packaged item

Item	Unit price	(5for\$20.00) <small>preset</small>
	Quantity	3
	PLU	28
Payment	Cash	\$15.00

**OPERATION**

3 X / FOR  
DATE  
TIME  
 Quantity being purchased  
 (4-digit integer/2-digit decimal)

5 X / FOR  
DATE  
TIME  
 Package quantity  
 (4-digit integer/2-digit decimal)

2 8 PLU

SUB  
TOTAL

1 5 00 CA / AMT  
TEND

**RECEIPT**

3 PLU0028	· 12.00	Quantity/result
3X @5/ 20.00		or
PLU0028	· 12.00	Quantity/unit q'ty/@
TL	- 12.00	Result
CASH	· 15.00	
CG	· 3.00	

- If X / FOR  
DATE  
TIME is not allocated on the keyboard, key allocation is necessary.

## Open PLU

Item 1	Unit price	\$32.80
	Quantity	1
	PLU	30
Item 2	Unit price	\$13.00
	Quantity	2
	PLU	31
Payment	Cash	\$60.00

**OPERATION**

3 0 PLU  
3 2 8 0 PRICE  
 Unit price

3 1 PLU  
1 3 00 PRICE  
 Repeat PRICE

SUB  
TOTAL

6 0 00 CA / AMT  
TEND

**RECEIPT**

1 PLU0030	· 32.80	
1 PLU0031	· 13.00	
1 PLU0031	· 13.00	
TL	- 58.80	
CASH	· 60.00	
CG	· 1.20	

- Before registering an open PLU, it is necessary to preset it as an open PLU.



# Shifting the taxable status of an item

By pressing “Tax Shift” key, you can shift the taxable status of an item.

**REG**

Mode switch

## Calculation merchandise subtotal

			OPERATION	RECEIPT																																	
Item 1	Dept. 1	\$4.00	<b>4 00</b> <b>1</b>	<table border="1"> <tr><td>1 DEPT01</td><td>T2</td><td>-4.00</td></tr> <tr><td>1 DEPT02</td><td>T1</td><td>-2.00</td></tr> <tr><td>1 DEPT03</td><td>T12</td><td>-6.00</td></tr> <tr><td>1 DEPT04</td><td></td><td>-7.00</td></tr> <tr><td>TA1</td><td></td><td>-8.00</td></tr> <tr><td>TX1</td><td></td><td>-0.32</td></tr> <tr><td>TA2</td><td></td><td>-10.00</td></tr> <tr><td>TX2</td><td></td><td>-0.50</td></tr> <tr><td>TL</td><td></td><td>-19.82</td></tr> <tr><td>CASH</td><td></td><td>-20.00</td></tr> <tr><td>CG</td><td></td><td>-0.18</td></tr> </table>	1 DEPT01	T2	-4.00	1 DEPT02	T1	-2.00	1 DEPT03	T12	-6.00	1 DEPT04		-7.00	TA1		-8.00	TX1		-0.32	TA2		-10.00	TX2		-0.50	TL		-19.82	CASH		-20.00	CG		-0.18
	1 DEPT01	T2	-4.00																																		
	1 DEPT02	T1	-2.00																																		
1 DEPT03	T12	-6.00																																			
1 DEPT04		-7.00																																			
TA1		-8.00																																			
TX1		-0.32																																			
TA2		-10.00																																			
TX2		-0.50																																			
TL		-19.82																																			
CASH		-20.00																																			
CG		-0.18																																			
Quantity	1	<b>2 00</b> <b>2</b>																																			
Taxable	(2) <sub>preset</sub>	Pressing <b>T/S1</b> changes the tax status from Nontaxable to Taxable 1																																			
Item 2	Dept. 2	\$2.00	<b>6 00</b> <b>3</b>																																		
	Quantity	1	Pressing <b>T/S2</b> changes the tax status from Taxable 1 to Taxable 1, 2																																		
	Taxable	(No)→1																																			
Item 3	Dept. 3	\$6.00	<b>7 00</b> <b>4</b>																																		
	Quantity	1	Pressing <b>T/S2</b> changes the tax status from Taxable 2 to Nontaxable																																		
	Taxable	(1)→1, 2																																			
Item 4	Dept. 4	\$7.00	<b>2 0 0 0</b> <b>CA/AMT/TEND</b>																																		
	Quantity	1	<b>SUB TOTAL</b>																																		
	Taxable	(2)→No																																			
Payment	Cash	\$20.00																																			

### Important!

- To change the tax status of the next item to be registered, be sure to press **T/S1**, **T/S2**.  
If the last item registered is programmed as nontaxable, a discount (**%-** key) operation on this item is always nontaxable.  
In this case, you cannot manually change the tax status to Taxable 1 or 2 by pressing the **T/S1**, **T/S2** keys.

## Preparing and using discounts

This section describes how to prepare and register discounts.

### Programming discounts

To program a rate to the **%-** key

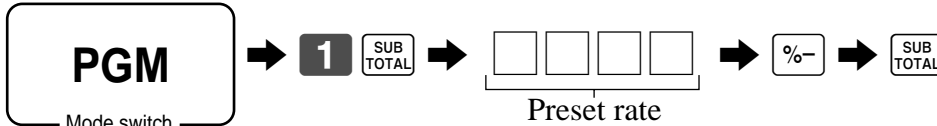

**Example:**

10% ⇨ **1 0**  
 5.5% ⇨ **5 . 5**  
 12.34% ⇨ **1 2 . 3 4**

### Registering discounts



The following example shows how you can use the **%-** key in various types of registration.

### Discount for items and subtotals

	Dept. 1	\$5.00
Item 1	Quantity	1
	Taxable	(1) <sub>preset</sub>
Item 2	PLU 16 (\$10.00) <sub>preset</sub>	
	Quantity	1
	Taxable	(2) <sub>preset</sub>
Discount	Rate	(5%) <sub>preset</sub>
Subtotal discount	Rate	3.5%
	Taxable	Nontaxable
Payment	Cash	\$15.00

#### OPERATION

#### RECEIPT

**5 00** **1**  
**1 6** **PLU**  
**%-**  
 Applies the preset discount rate to the last item registered.

**3 . 5** **%-**  
**SUB TOTAL**  
 The input value takes priority of the preset value.

**1 5 00** **CA/AMT TEND**

1 DEPT01	T1	-5.00
1 PLU0016	T2	· 10.00
5%		
%-	T2	-0.50
ST		· 14.50
3.5%		
%-		-0.51
TA1		· 5.00
TX1		· 0.20
TA2		· 9.50
TX2		· 0.48
TL		- 14.67
CASH		· 15.00
CG		· 0.33

- You can manually input rates up to 4 digits long (0.01% to 99.99%).

### Taxable status of the **%-** key

- Whenever you perform a discount operation on the last item registered, the tax calculation for discount amount is performed in accordance with the tax status programmed for that item.
- Whenever you perform a discount operation on a subtotal amount, the tax calculation for the subtotal amount is performed in accordance with the tax status programmed for the **%-** key.

# Preparing and using reductions

This section describes how to prepare and register reductions.

## Programming for reductions

You can use the **[-]** key to reduce single item or subtotal amounts.

### To program preset reduction amount

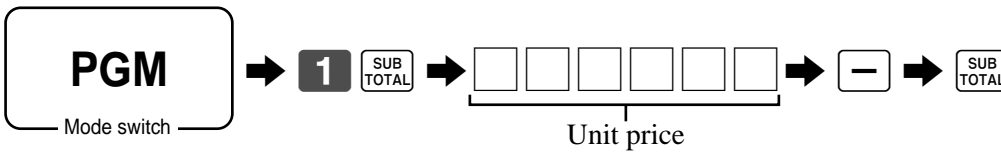

## Registering reductions



The following examples show how you can use the **[-]** key in various types of registration.

### Reduction for items

OPERATION			RECEIPT																																				
Item 1	Dept. 1	\$5.00	<div style="display: flex; justify-content: space-between;"> <div style="width: 40%;"> <p style="text-align: center;"> <b>5 00</b> <b>1</b>  <b>2 5</b> <b>[-]</b>                      Reduces the last amount registered by the value input.  <b>4 5</b> <b>PLU</b>  <b>[-]</b>  <b>SUB TOTAL</b>  <b>1 1 00</b> <b>CA/AMT/TEND</b> </p> </div> <div style="width: 55%; border: 1px solid black; padding: 5px;"> <table style="width: 100%; border-collapse: collapse;"> <tr><td style="width: 15%;">1 DEPT01</td><td style="width: 15%;">T1</td><td style="width: 15%;">-5.00</td><td style="width: 55%;"></td></tr> <tr><td>-</td><td>T1</td><td>-0.25</td><td></td></tr> <tr><td>1 PLU0045</td><td>T1</td><td>-6.00</td><td></td></tr> <tr><td>-</td><td>T1</td><td>-0.50</td><td></td></tr> <tr><td>TA1</td><td></td><td>-10.25</td><td></td></tr> <tr><td>TX1</td><td></td><td>-0.41</td><td></td></tr> <tr><td>TL</td><td></td><td>-10.66</td><td></td></tr> <tr><td>CASH</td><td></td><td>-11.00</td><td></td></tr> <tr><td>CG</td><td></td><td>-0.34</td><td></td></tr> </table> </div> </div>	1 DEPT01	T1	-5.00		-	T1	-0.25		1 PLU0045	T1	-6.00		-	T1	-0.50		TA1		-10.25		TX1		-0.41		TL		-10.66		CASH		-11.00		CG		-0.34	
1 DEPT01	T1	-5.00																																					
-	T1	-0.25																																					
1 PLU0045	T1	-6.00																																					
-	T1	-0.50																																					
TA1		-10.25																																					
TX1		-0.41																																					
TL		-10.66																																					
CASH		-11.00																																					
CG		-0.34																																					
	Quantity	1																																					
	Taxable	(1) <sub>preset</sub>																																					
Reduction	Amount	\$0.25																																					
Item 2	PLU 45	(\$6.00) <sub>preset</sub>																																					
	Quantity	1																																					
	Taxable	(1) <sub>preset</sub>																																					
Reduction	Amount	(\$0.50) <sub>preset</sub>																																					
Payment	Cash	\$11.00																																					

- You can manually input reduction values up to 7 digits long.
- If you want to subtract the reduction amount from the department or PLU totalizer, program “Net totaling.”

# Basic Operations and Setups

## Reduction for subtotal

### OPERATION

### RECEIPT

Item 1	Dept. 1	\$3.00
	Quantity	1
	Taxable	(1) <sub>preset</sub>
Item 2	Dept. 2	\$4.00
	Quantity	1
	Taxable	(2) <sub>preset</sub>
Subtotal Reduction	Amount	\$0.75
	Taxable	(No) <sub>preset</sub>
Payment	Cash	\$7.00

**3 00** **1**

**4 00** **2**

SUB  
TOTAL

**7 5** **-**

Reduces the subtotal by the value input here.

SUB  
TOTAL

**7 00** CA/AMT  
/TEND

1	DEPT01	T1	·3.00
1	DEPT02	T2	·4.00
-			-0.75
	TA1		·3.00
	TX1		·0.12
	TA2		·4.00
	TX2		·0.20
	TL		-6.57
	CASH		·7.00
	CG		·0.43

# Registering credit and check payments

The following examples show how to register credits and payments by check.

**REG**

Mode switch

## Check

### OPERATION

### RECEIPT

Item	Dept. 1	\$11.00
	Quantity	1
Payment	Check	\$20.00

1 1 00 1  
SUB TOTAL  
2 0 00 CHK/TEND

1 DEPT01	.11.00
TL	- 11.00
CHECK	.20.00
CG	.9.00

## Credit

### OPERATION

### RECEIPT

Item	Dept. 4	\$15.00
	Quantity	1
Reference	Number	1234
Payment	Credit	\$15.00

1 5 00 4  
SUB TOTAL  
1 2 3 4 #/NS  
CR1

1 DEPT04	.15.00	
#/NS	1234	Reference No.
TL	- 15.00	
CREDIT1	.15.00	

## Mixed tender (cash, credit and check)

### OPERATION

### RECEIPT

Item	Dept. 4	\$55.00
	Quantity	1
Payment	Check	\$30.00
	Cash	\$5.00
	Credit	\$20.00

5 5 00 4  
SUB TOTAL  
3 0 00 CHK/TEND  
5 00 CA/AMT TEND  
CR1

1 DEPT04	.55.00
TL	- 55.00
CHECK	.30.00
CASH	.5.00
CREDIT1	.20.00

## Registering both the Euro and local currency



The following example shows the basic operation using the currency exchange function between the Euro and the local currency.

### Case A

Main currency	Local
Payment	Euro
Change	Local
Rate	1 Euro = 0.5 FFr

#### OPERATION

#### DISPLAY

**6 0 0** **1**

**PD**

← Press the **PD** key, which converts the subtotal amount into the sub currency by applying the preset exchange rate.

0.00E

**SUB  
TOTAL**

After you press the **SUB  
TOTAL** key, the result is shown on the display.

12.00E

**PD**

← Press the **PD** key if you enter the payment in the sub currency.

0.00E

**1 5 00**

15.00E

**CA/AMT  
/TEND**

← Press the **CA/AMT  
/TEND** key to finalize the transaction.  
The change amount is shown in the programmed currency.

1.50

#### RECEIPT

1 DEPT01	·6.00
TL	- 6.00
	( 12.00)
EUR0 money	
CASH	15.00
CG	·1.50
	( 3.00)

## Case B

Main currency	Euro
Payment	Local
Change	Euro
Rate	1 Euro = 0.5 FFr

OPERATION	DISPLAY
<b>1 2 00</b> <input type="text" value="1"/>	
<input type="text" value="PD"/>	<div style="border: 1px solid black; padding: 2px; text-align: right;">0.00L</div>
<input type="text" value="SUB TOTAL"/>	<div style="border: 1px solid black; padding: 2px; text-align: right;">6.00L</div>
<input type="text" value="PD"/>	<div style="border: 1px solid black; padding: 2px; text-align: right;">0.00L</div>
<b>6 00</b>	<div style="border: 1px solid black; padding: 2px; text-align: right;">6.00L</div>
<input type="text" value="CA/AMT/TEND"/>	<div style="border: 1px solid black; padding: 2px; text-align: right;">0.00</div>

← Press the  key, which converts the subtotal amount into the sub currency by applying the preset exchange rate.  
 After you press the  key, the result is shown on the display.

← Press the  key if you enter the payment in the sub currency.

← Press the  key to finalize the transaction.  
 The change amount is shown in the programmed currency.

0.00L
6.00L
0.00L
6.00L
0.00

### RECEIPT

1 DEPT01	12.00
TL	12.00
	(-6.00)
LOCAL money	
CASH	-6.00
CG	0.00
	(-0.00)

## Registering returned goods in the REG mode

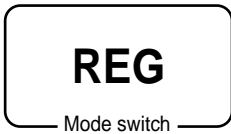

The following example shows how to use the **RF** key in the REG mode to register goods returned by customers.

OPERATION			RECEIPT
Item 1	Dept. 1	\$2.35	<pre> 1 DEPT01          .2.35 1 DEPT02          .2.00 1 PLU0001         .1.20 RF                ..... 1 DEPT01          -2.35 RF                ..... 1 PLU0001         -1.20 TL                - 2.00 CASH              .2.00                     </pre>
	Quantity	1	
Item 2	Dept. 2	\$2.00	
	Quantity	1	
Item 3	PLU 1	(\$1.20) <sub>preset</sub>	
	Quantity	1	
Returned Item 1	Dept. 1	\$2.35	
	Quantity	1	
Returned Item 3	PLU 1	(\$1.20) <sub>preset</sub>	
	Quantity	1	
Payment	Cash	\$2.00	

2 3 5 1  
2 00 2  
1 PLU  
RF  
2 3 5 1  
 Press **RF** before the item you want to return.  
RF  
1 PLU  
SUB TOTAL  
CA/AMT TEND

## Registering returned goods in the RF mode

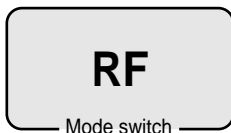

The following examples show how to use the RF mode to register goods returned by customers.

### Normal refund transaction

OPERATION			RECEIPT
Returned Item 1	Dept. 1	\$1.50	<pre> RF 03-06-2000(SAT) 11:50 C01          MC#01      000023 2 DEPT01          .3.00 6 PLU0002         .7.20 TL                - 10.20 CASH              .10.20                     </pre>
	Quantity	2	
Returned Item 2	PLU 2	(\$1.20) <sub>preset</sub>	
	Quantity	6	
Payment	Cash	\$10.20	

1 5 0 1  
1  
6 X/DATE TIME  
2 PLU  
CA/AMT TEND

RF mode symbol

- The model for the U.S./Canada, use X/FOR DATE TIME instead of X/DATE TIME.



## Reduction of amounts paid on refund

OPERATION			RECEIPT		
Returned Item 1	Dept. 3	\$4.00	4 00 3	1 DEPT03	T1 .4.00
	Quantity	1	1 5 -	-	T1 -0.15
Reduction	Amount	\$0.15	2 PLU	1 PLU0002	T2 .1.20
Returned Item 2	PLU 2	(\$1.20) <sub>preset</sub>	%-	5%	T2 -0.06
	Quantity	1	SUB TOTAL	TA1	.3.85
Discount	Rate	(5%) <sub>preset</sub>	CA/AMT TEND	TX1	.0.15
Payment	Cash	\$5.20		TA2	.1.14
				TX2	.0.06
				TL	-5.20
				CASH	.5.20

### Important!

- To avoid miss registrations in the RF mode, return the mode switch to the former position immediately.

## Registering money received on account



The following example shows how to register money received on account. This registration must be performed out of a sale.

OPERATION		RECEIPT	
Received amount	\$700.00	7 00 00 RC	RC .700.00
Amount can be up to 8 digits.			

## Registering money paid out



The following example shows how to register money paid out from the register. This registration must be performed out of a sale.

OPERATION		RECEIPT	
Paid out amount	\$1.50	1 5 0 PD	PD .1.50
Amount can be up to 8 digits.			

## Registering loan amounts

**REG**

Mode switch

Use this procedure to register loan or bank received from the office.

### OPERATION

### RECEIPT

Item	Note	\$1.00
	Quantity	10
	Note	\$5.00
	Quantity	5
Media	Cash	\$35.00

DATE TIME  
**1 0**  DATE TIME  
**1 00** LOAN  
**5**  DATE TIME  
**5 00** LOAN  
 CA/AMT/TEND

LOAN	·10.00
LOAN	·25.00
CASH	·35.00

- The model for the U.S./Canada, use  FOR DATE TIME instead of  DATE TIME.

## Registering pick up amounts

**REG**

Mode switch

Use this procedure to register pick up money from cash drawer.

### OPERATION

### RECEIPT

Item	Coin	\$0.50
	Quantity	10
	Coin	\$0.10
	Quantity	5
Media	Cash	\$5.50

DATE TIME  
**1 0**  DATE TIME  
**5 0** PICK UP  
**5**  DATE TIME  
**1 0** PICK UP  
 CA/AMT/TEND

P. UP	·5.00
P. UP	·0.50
CASH	·5.50

- The model for the U.S./Canada, use  FOR DATE TIME instead of  DATE TIME.

## Changing media in drawer

**REG**

Mode switch

Use this procedure to change media in drawer.

### OPERATION

### RECEIPT

Media	Check	-10.00
	Cash	\$8.00
	Charge	\$2.00

MEDIA CHANGE  
**1 0 00**  CHK/TEND  
 Enter the amount to be changed.  
**8 00** CA/AMT/TEND  
**2 00** CH

MEDIA CHG	· . . . . .
CHECK	·10.00
CASH	·8.00
CH	·2.00

# Making corrections in a registration

**REG**

Mode switch

There are three techniques you can use to make corrections in a registration.

- To correct an item that you input but not yet registered.
- To correct the last item you input and registered.
- To cancel all items in a transaction.

## To correct an item you input but not yet registered

OPERATION

RECEIPT

<p>2 00</p> <p>C</p> <p>1 00</p> <p>1 2</p> <p>X/DATE TIME</p> <p>C</p> <p>1 1</p> <p>X/DATE TIME</p> <p>2 00</p> <p>2</p> <p>C</p> <p>3</p> <p>PLU</p> <p>1 5</p> <p>PLU</p> <p>6 00</p> <p>C</p> <p>1 5</p> <p>PLU</p> <p>Enter PLU No. again.</p> <p>1 0 00</p> <p>PRICE</p> <p>SUB TOTAL</p> <p>1 0 00</p> <p>C</p> <p>1 5 00</p> <p>CA/AMT /TEND</p> <p>CR1</p>	<p>— Correction of unit price</p> <p>— Correction of quantity</p> <p>— Correction of PLU No.</p> <p>— Correction of open PLU unit price</p> <p>— Correction of partial tender amount</p>	<table border="0"> <tr><td>1</td><td>DEPT01</td><td style="text-align: right;">.1.00</td></tr> <tr><td>11</td><td>DEPT02</td><td style="text-align: right;">.22.00</td></tr> <tr><td>1</td><td>PLU0003</td><td style="text-align: right;">.1.30</td></tr> <tr><td>1</td><td>PLU0015</td><td style="text-align: right;">.10.00</td></tr> <tr><td></td><td>TL</td><td style="text-align: right;">- 34.30</td></tr> <tr><td></td><td>CASH</td><td style="text-align: right;">.15.00</td></tr> <tr><td></td><td>CREDIT1</td><td style="text-align: right;">.19.30</td></tr> </table>	1	DEPT01	.1.00	11	DEPT02	.22.00	1	PLU0003	.1.30	1	PLU0015	.10.00		TL	- 34.30		CASH	.15.00		CREDIT1	.19.30
1	DEPT01	.1.00																					
11	DEPT02	.22.00																					
1	PLU0003	.1.30																					
1	PLU0015	.10.00																					
	TL	- 34.30																					
	CASH	.15.00																					
	CREDIT1	.19.30																					

- The model for the U.S./Canada, use  instead of .

# Basic Operations and Setups

## To correct an item you input and registered

### OPERATION

### RECEIPT

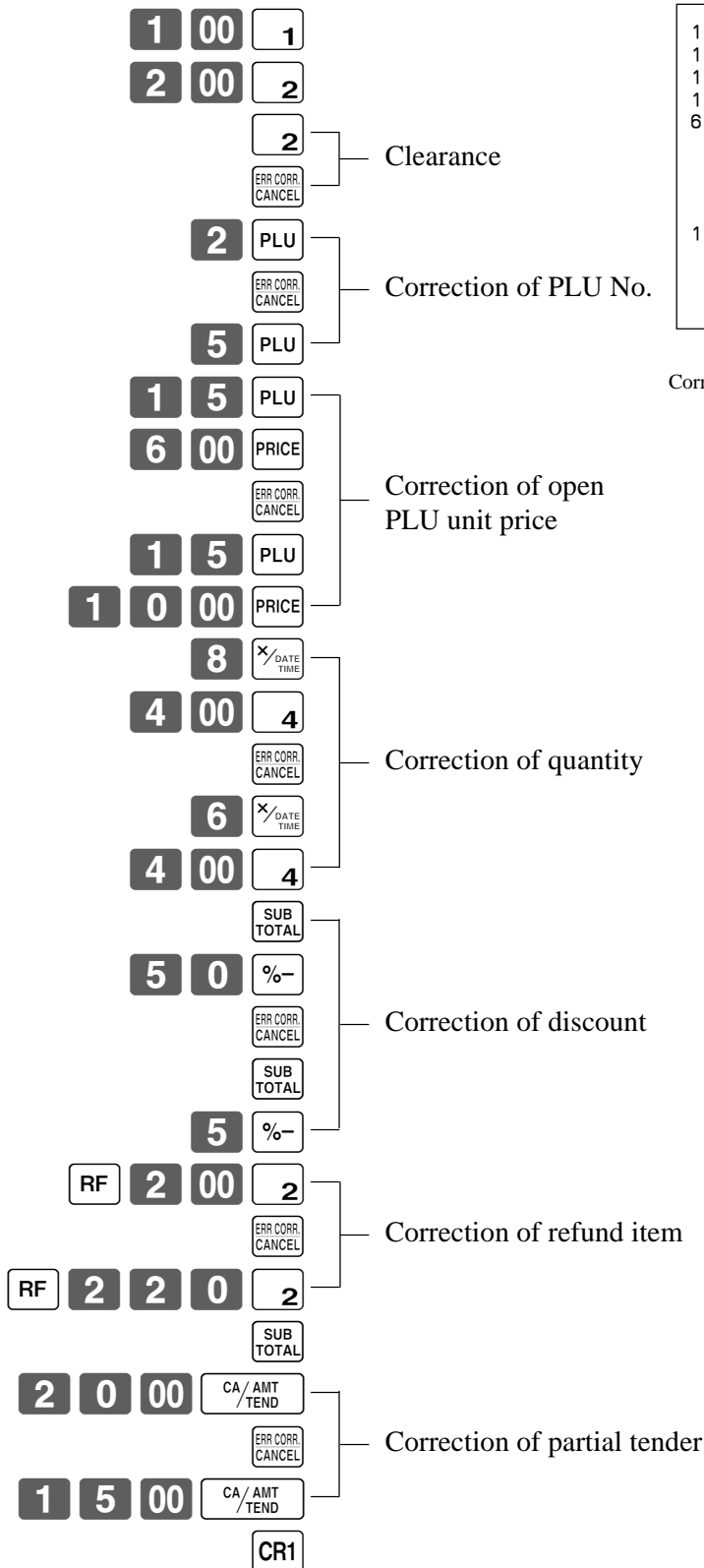

1	DEPT01	.1.00
1	DEPT02	.2.00
1	PLU0005	.1.50
1	PLU0015	.10.00
6	DEPT04	.24.00
	ST	.38.50
	5%	
	%-	-1.93
	RF	.....
1	DEPT02	-2.20
	TL	<b>-34.37</b>
	CASH	.15.00
	CREDIT1	.19.37

Corrected items are not printed on receipt.

• The model for the U.S./Canada, use  FOR DATE TIME instead of  DATE TIME.

## To cancel all items in a transaction

OPERATION	RECEIPT										
<div style="display: flex; flex-direction: column; align-items: center;"> <div style="display: flex; gap: 5px;"> <div style="border: 1px solid black; padding: 2px 5px;">1</div> <div style="border: 1px solid black; padding: 2px 5px;">00</div> <div style="border: 1px solid black; padding: 2px 5px;">1</div> </div> <div style="display: flex; gap: 5px;"> <div style="border: 1px solid black; padding: 2px 5px;">2</div> <div style="border: 1px solid black; padding: 2px 5px;">00</div> <div style="border: 1px solid black; padding: 2px 5px;">2</div> </div> <div style="display: flex; gap: 5px;"> <div style="border: 1px solid black; padding: 2px 5px;">3</div> <div style="border: 1px solid black; padding: 2px 5px;">00</div> <div style="border: 1px solid black; padding: 2px 5px;">3</div> </div> <div style="display: flex; gap: 5px;"> <div style="border: 1px solid black; padding: 2px 5px;">4</div> <div style="border: 1px solid black; padding: 2px 5px;">00</div> <div style="border: 1px solid black; padding: 2px 5px;">4</div> </div> <div style="border: 1px solid black; padding: 2px 5px; margin-top: 5px;">SUB TOTAL</div> </div>	<div style="border: 1px solid black; padding: 5px;"> <table style="width: 100%; border-collapse: collapse;"> <tr><td style="width: 80%;">1 DEPT01</td><td style="text-align: right;">-1.00</td></tr> <tr><td>1 DEPT02</td><td style="text-align: right;">-2.00</td></tr> <tr><td>1 DEPT03</td><td style="text-align: right;">-3.00</td></tr> <tr><td>1 DEPT04</td><td style="text-align: right;">-4.00</td></tr> <tr><td>CANCEL</td><td style="text-align: right;">.....</td></tr> </table> </div>	1 DEPT01	-1.00	1 DEPT02	-2.00	1 DEPT03	-3.00	1 DEPT04	-4.00	CANCEL	.....
1 DEPT01	-1.00										
1 DEPT02	-2.00										
1 DEPT03	-3.00										
1 DEPT04	-4.00										
CANCEL	.....										
<p>Pressing <span style="border: 1px solid black; padding: 1px 2px;">SUB TOTAL</span> key is necessary to cancel the transaction.</p> <div style="border: 1px solid black; padding: 2px 5px; margin-top: 10px; width: fit-content;">ERR CORR. CANCEL</div>											

## No sale registration



You can use the following procedure to open the drawer without registering a sale. This operation must be performed out of a sale.

OPERATION	RECEIPT		
<div style="border: 1px solid black; padding: 2px 5px; display: inline-block;"># NS</div>	<table style="width: 100%; border-collapse: collapse;"> <tr> <td style="width: 80%;">#/NS</td> <td style="text-align: right;">.....</td> </tr> </table>	#/NS	.....
#/NS	.....		

## Printing the daily sales reset report

This report shows daily sales totals.

**OPERATION**

**REPORT**

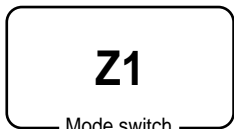

Mode switch



Z	03-06-2000(SAT)	17:00		Date/time
C01	MC#01	000231		Clerk name/mc No./consecutive No.
-----				
Z	BATCH 01			Report title
-----				
Z	FIX	0001		Fixed total report title/reset counter
		0001011		Report code
-----				
GROSS		981.25		Gross total *2
		.6,574.40		
NET	No	111		Net total *2
		.7,057.14		
CAID		.1,919.04		Cash in drawer *2
CHID		.139.04		Charge in drawer *2
CKID		.859.85		Check in drawer *2
CRID(1)		.709.85		Credit in drawer *2
-----				
RF	No	3		Refund mode *2
		.10.22		
CUST	CT	111		Number of customer *2
AVRG		.63.57		Average sales per customer *2
DC		.1.22		Discount total *2
REF		.2.42		Refund key *2
CLEAR	No	85		Clear key count *2
ROUND		.0.00		Rounding total *2
CANCEL	No	2		Cancellation *2
		.12.97		
-----				
TA1		.2,369.69		Taxable 1 amount *2
TX1		.128.86		Tax 1 amount *2
TA2		.2,172.96		Taxable 2 amount *2
TX2		.217.33		Tax 2 amount *2
-----				
GT1		.00000000125478.96		Grand total 1 *2
GT2		.00000000346284.23		Grand total 2 *2
GT3		.00000000123212.75		Grand total 3 *2
-----				
Z	TRANS	0001		Function key report title/reset counter
		0001012		Report code
CASH	No	362		Function key count/amount *1
		.1,638.04		
CHARGE	No	56		
		.1,174.85		

RC	No	4		
			·810.00	
PD	No	5		
			·520.00	
<hr/>				
CORR	No	14		
			·39.55	
VLD	No	19		
RCT	No	3		
NS	No	5		
<hr/>				
Z	DEPT		0001	Department report title/reset counter
			0001015	Report code
DEPT01			203.25	Department count/amount *1
			·1,108.54	
DEPT02			183	
			·1,362.26	
			5	
<hr/>				
TL			421.25	Department total count/total amount
			·2,872.28	
<hr/>				
Z	CASHIER		0001	Clerk report title/reset counter
			0001017	Report code
C01			1	Clerk name/drawer No. *1
GROSS			421.25	Gross total *1
			·2,872.28	
NET	No	111		Net total *1
			·1,845.35	
CAID			·1,057.14	Cash in drawer *1
CHID			·139.04	
RF	No	1		Refund mode *1
			·1.00	
CLEAR	No	5		Clear key count *1
			·4.43	
C02			1	Clerk name/drawer No.

\*1 Zero totalled departments/functions/clerks are not printed by programming.

\*2 These items can be skipped by programming.

This chapter describes more sophisticated operations that you can use to suit the needs of your retail environment.

## Stock check

Each PLU has an actual stock totalizer that you can program with a minimum stock quantity. Then the register checks actual stock quantities against the programmed minimum stock quantities. Stock operations are performed only for PLUs (except scanning PLUs) programmed with minimum stock quantities.

### Stock warnings

The cash register checks for negative values in actual stock quantities during the registration itself. After registration is complete, it checks actual stock quantities against minimum stock quantities. The following warning indicators are used to inform the operator of any problem.

- **Negative stock:**

This indicates that the actual stock quantity is negative. You can also program the cash register to treat this condition as an error. This warning does not appear when the actual stock quantity is zero.

- **Under minimum stock:**

This indicates that the actual stock quantity is less than or equal to the minimum stock quantity. The cash register can be programmed so that a buzzer sounds when the actual stock quantity is less than the minimum stock quantity.

#### Notes

- The stock check operation is also performed for PLUs programmed with minimum stock quantities that make up set menus.
- None of the warning indicators appear unless the cash register is specifically programmed for the stock check operation.
- Stock operations can be performed for registrations in the RF mode or those performed with <REFUND> (the refund key).
- An error correct, void, or cancel operation restores the original of items in stock value.

## Clerk interrupt function

There are two types of clerk interrupt function, illustrated by PROCEDURE 1 and PROCEDURE 2 below.

- In PROCEDURE 1, each clerk possesses a unique clerk interrupt buffer, and so the clerk interrupt function gives each individual clerk the ability to perform an independent registration operation. In this case, each clerk is individually linked to a unique clerk interrupt buffer.
- In PROCEDURE 2, multiple clerks use the same clerk interrupt buffer, and so a single clerk interrupt operation (clerk change during registration) can be performed any registration is in progress. In this case, multiple clerks are linked to a single clerk interrupt buffer.

Note the following important points concerning the clerk interrupt function.

- The register must be programmed to allow use of the clerk interrupt function.
- To use the clerk interrupt function, a clerk interrupt buffer must first be allocated with the memory allocation operation. Next the manager control operation (X1 mode) should be used to perform clerk assignment for the clerk interrupt function. The clerk interrupt operation cannot be performed by clerks who are not linked to a clerk interrupt buffer.
- You cannot use the clerk interrupt function on a register set up to function as part of a check tracking system. In the REG1, REG2, and RF modes, clerks can be change while a transaction is in progress, making it possible for multiple clerks to simultaneously perform registrations using a single register. For example, if clerk 1 is interrupted while registering a transaction, clerk 2 can use the same machine to register a different transaction. Then clerk 1 can continue the original registration from the point where it was interrupted.





# Advanced Operations

## Example 2

	OPERATION	RECEIPT																					
<table border="1" style="width: 100%; border-collapse: collapse;"> <tr> <td style="width: 15%;"></td> <td style="width: 15%;">Dept. 1</td> <td style="width: 70%;">(\$1.00)</td> </tr> <tr> <td>Item</td> <td>Quantity</td> <td>3</td> </tr> <tr> <td></td> <td>Status</td> <td>S.I.S</td> </tr> <tr> <td>Payment</td> <td>Cash</td> <td>\$3.00</td> </tr> </table>		Dept. 1	(\$1.00)	Item	Quantity	3		Status	S.I.S	Payment	Cash	\$3.00	<div style="display: flex; justify-content: space-around; align-items: center;"> <div style="border: 1px solid black; padding: 2px;">3</div> <div style="border: 1px solid black; padding: 2px; font-size: 0.8em;">X/DATE TIME</div> </div> <div style="display: flex; justify-content: space-around; align-items: center; margin-top: 10px;"> <div style="border: 1px solid black; padding: 2px;">1</div> </div> <p style="font-size: 0.9em;">The transaction is immediately finalized.</p>	<table border="1" style="width: 100%; border-collapse: collapse;"> <tr> <td style="width: 15%;"></td> <td style="width: 15%;">3 DEPT01</td> <td style="width: 70%; text-align: right;">-3.00</td> </tr> <tr> <td></td> <td>TL</td> <td style="text-align: right;">- 3.00</td> </tr> <tr> <td></td> <td>CASH</td> <td style="text-align: right;">-3.00</td> </tr> </table>		3 DEPT01	-3.00		TL	- 3.00		CASH	-3.00
	Dept. 1	(\$1.00)																					
Item	Quantity	3																					
	Status	S.I.S																					
Payment	Cash	\$3.00																					
	3 DEPT01	-3.00																					
	TL	- 3.00																					
	CASH	-3.00																					

- The model for the U.S./Canada, use  FOR DATE TIME instead of  DATE TIME.

## Example 3

	OPERATION	RECEIPT																															
<table border="1" style="width: 100%; border-collapse: collapse;"> <tr> <td style="width: 15%;"></td> <td style="width: 15%;">Dept. 3</td> <td style="width: 70%;">\$2.00</td> </tr> <tr> <td rowspan="2">Item 1</td> <td>Quantity</td> <td>1</td> </tr> <tr> <td>Status</td> <td>Normal</td> </tr> <tr> <td rowspan="2">Item 2</td> <td>Dept. 1</td> <td>\$1.00</td> </tr> <tr> <td>Quantity</td> <td>1</td> </tr> <tr> <td></td> <td>Status</td> <td>S.I.S</td> </tr> <tr> <td>Payment</td> <td>Cash</td> <td>\$3.00</td> </tr> </table>		Dept. 3	\$2.00	Item 1	Quantity	1	Status	Normal	Item 2	Dept. 1	\$1.00	Quantity	1		Status	S.I.S	Payment	Cash	\$3.00	<div style="display: flex; justify-content: space-around; align-items: center;"> <div style="border: 1px solid black; padding: 2px;">2</div> <div style="border: 1px solid black; padding: 2px;">00</div> <div style="border: 1px solid black; padding: 2px;">3</div> </div> <div style="display: flex; justify-content: space-around; align-items: center; margin-top: 10px;"> <div style="border: 1px solid black; padding: 2px;">1</div> </div> <p style="font-size: 0.9em;">The transaction is not finalized. Because another item is registered before the single item sales department.</p> <div style="border: 1px solid black; padding: 2px; margin-top: 10px; width: fit-content; margin-left: auto;">CA/AMT TEND</div>	<table border="1" style="width: 100%; border-collapse: collapse;"> <tr> <td style="width: 15%;"></td> <td style="width: 15%;">1 DEPT03</td> <td style="width: 70%; text-align: right;">-2.00</td> </tr> <tr> <td></td> <td>1 DEPT01</td> <td style="text-align: right;">-1.00</td> </tr> <tr> <td></td> <td>TL</td> <td style="text-align: right;">- 3.00</td> </tr> <tr> <td></td> <td>CASH</td> <td style="text-align: right;">-3.00</td> </tr> </table>		1 DEPT03	-2.00		1 DEPT01	-1.00		TL	- 3.00		CASH	-3.00
	Dept. 3	\$2.00																															
Item 1	Quantity	1																															
	Status	Normal																															
Item 2	Dept. 1	\$1.00																															
	Quantity	1																															
	Status	S.I.S																															
Payment	Cash	\$3.00																															
	1 DEPT03	-2.00																															
	1 DEPT01	-1.00																															
	TL	- 3.00																															
	CASH	-3.00																															

# Addition

## Addition (plus)

### Example

	OPERATION	RECEIPT																																					
<table border="1" style="width: 100%; border-collapse: collapse;"> <tr> <td style="width: 15%;"></td> <td style="width: 15%;">Dept. 1</td> <td style="width: 70%;">\$1.00</td> </tr> <tr> <td rowspan="2">Item 1</td> <td>Quantity</td> <td>1</td> </tr> <tr> <td>Addition</td> <td>\$0.10</td> </tr> <tr> <td rowspan="2">Item 2</td> <td>Dept. 1</td> <td>\$2.00</td> </tr> <tr> <td>Quantity</td> <td>3</td> </tr> <tr> <td></td> <td>Addition</td> <td>3 × (\$0.20)</td> </tr> <tr> <td>Payment</td> <td>Cash</td> <td>\$7.70</td> </tr> </table>		Dept. 1	\$1.00	Item 1	Quantity	1	Addition	\$0.10	Item 2	Dept. 1	\$2.00	Quantity	3		Addition	3 × (\$0.20)	Payment	Cash	\$7.70	<div style="display: flex; justify-content: space-around; align-items: center;"> <div style="border: 1px solid black; padding: 2px;">1</div> <div style="border: 1px solid black; padding: 2px;">00</div> <div style="border: 1px solid black; padding: 2px;">1</div> </div> <div style="display: flex; justify-content: space-around; align-items: center; margin-top: 10px;"> <div style="border: 1px solid black; padding: 2px;">1</div> <div style="border: 1px solid black; padding: 2px;">0</div> <div style="border: 1px solid black; padding: 2px;">+</div> </div> <div style="display: flex; justify-content: space-around; align-items: center; margin-top: 10px;"> <div style="border: 1px solid black; padding: 2px;">3</div> <div style="border: 1px solid black; padding: 2px; font-size: 0.8em;">X/DATE TIME</div> </div> <div style="display: flex; justify-content: space-around; align-items: center; margin-top: 10px;"> <div style="border: 1px solid black; padding: 2px;">2</div> <div style="border: 1px solid black; padding: 2px;">00</div> <div style="border: 1px solid black; padding: 2px;">1</div> </div> <div style="display: flex; justify-content: space-around; align-items: center; margin-top: 10px;"> <div style="border: 1px solid black; padding: 2px;">3</div> <div style="border: 1px solid black; padding: 2px; font-size: 0.8em;">X/DATE TIME</div> </div> <div style="display: flex; justify-content: space-around; align-items: center; margin-top: 10px;"> <div style="border: 1px solid black; padding: 2px;">+</div> </div> <div style="border: 1px solid black; padding: 2px; margin-top: 10px; width: fit-content; margin-left: auto;">CA/AMT TEND</div>	<table border="1" style="width: 100%; border-collapse: collapse;"> <tr> <td style="width: 15%;"></td> <td style="width: 15%;">1 DEPT01</td> <td style="width: 70%; text-align: right;">-1.00</td> </tr> <tr> <td></td> <td>+</td> <td style="text-align: right;">-0.10</td> </tr> <tr> <td></td> <td>3 DEPT01</td> <td style="text-align: right;">-6.00</td> </tr> <tr> <td></td> <td>+</td> <td style="text-align: right;">-0.60</td> </tr> <tr> <td></td> <td>TL</td> <td style="text-align: right;">- 7.70</td> </tr> <tr> <td></td> <td>CASH</td> <td style="text-align: right;">-7.70</td> </tr> </table>		1 DEPT01	-1.00		+	-0.10		3 DEPT01	-6.00		+	-0.60		TL	- 7.70		CASH	-7.70
	Dept. 1	\$1.00																																					
Item 1	Quantity	1																																					
	Addition	\$0.10																																					
Item 2	Dept. 1	\$2.00																																					
	Quantity	3																																					
	Addition	3 × (\$0.20)																																					
Payment	Cash	\$7.70																																					
	1 DEPT01	-1.00																																					
	+	-0.10																																					
	3 DEPT01	-6.00																																					
	+	-0.60																																					
	TL	- 7.70																																					
	CASH	-7.70																																					

- The model for the U.S./Canada, use  FOR DATE TIME instead of  DATE TIME.

# Premium (%+)

## Example

OPERATION				RECEIPT																		
Item 1	Dept. 1	\$1.00	1 00 1	<table style="width: 100%; border-collapse: collapse;"> <tr><td style="width: 50%;">1 DEPT01</td><td style="text-align: right;">·1.00</td></tr> <tr><td>10%</td><td></td></tr> <tr><td>%+</td><td style="text-align: right;">·0.10</td></tr> <tr><td>3 DEPT01</td><td style="text-align: right;">·6.00</td></tr> <tr><td>ST</td><td style="text-align: right;">·7.10</td></tr> <tr><td>15%</td><td></td></tr> <tr><td>%+</td><td style="text-align: right;">·1.07</td></tr> <tr><td>TL</td><td style="text-align: right;">- 8.17</td></tr> <tr><td>CASH</td><td style="text-align: right;">·8.17</td></tr> </table>	1 DEPT01	·1.00	10%		%+	·0.10	3 DEPT01	·6.00	ST	·7.10	15%		%+	·1.07	TL	- 8.17	CASH	·8.17
	1 DEPT01	·1.00																				
	10%																					
%+	·0.10																					
3 DEPT01	·6.00																					
ST	·7.10																					
15%																						
%+	·1.07																					
TL	- 8.17																					
CASH	·8.17																					
Quantity	1		1 0 %+																			
Premium	10%		3 <input checked="" type="checkbox"/> DATE TIME																			
Item 2	Dept. 1	\$2.00	2 00 1																			
	Quantity	3	<input type="checkbox"/> SUB TOTAL																			
Subtotal	Premium	(15%)	<input type="checkbox"/> %+																			
Payment	Cash	\$8.17	<input type="checkbox"/> CA / AMT TEND																			

- The model for the U.S./Canada, use  FOR DATE TIME instead of  DATE TIME.

# Advanced Operations

## Tray total

### Tray total premium/discount

The buffer memory stores all items that fall into the prescribed range, starting from the first item registered for a transaction up to the point that <TRAY TOTAL> (the tray total key) is pressed to perform a tray total premium/discount operation. Following a premium/discount operation, the buffer is cleared and storage of new data starts from registration of the next item following the first premium/discount operation. The following operations clear the buffer memory.

- Press <TRAY TOTAL> twice.
- Press <TRAY TOTAL> and then perform a premium/discount operation. The contents of the buffer memory are restored if an error correction operation is performed to delete the premium/discount operation.

#### Example

OPERATION			RECEIPT		
Group 1	Dept. 1	\$1.00	1 00	1	1 DEPT01 .1.00
	Dept. 3	\$2.00	2 00	3	1 DEPT03 .2.00
	Discount	(5%) <sub>preset</sub>		TRAY TOTAL	TRAY TL - 3.00
Group 2	Dept. 3	\$3.00		%-	5% -0.15
	Dept. 4	\$4.00	3 00	3	1 DEPT03 .3.00
	Discount	10%	4 00	4	1 DEPT04 .4.00
Payment	Cash	\$9.15		TRAY TOTAL	TRAY TL - 7.00
				%-	10% -0.70
				TRAY TOTAL	TL - 9.15
				CA/AMT /TEND	CASH -9.15

### Multiple item totalling function

This function accumulates all items registered from the first item registered up to point that <TRAY TOTAL> is pressed, or all items between two presses of <TRAY TOTAL>. Pressing <TRAY TOTAL> displays the total amount with the tax included and prints it on the receipt and journal (printing on receipt and journal is programmable.)

#### Example

OPERATION			RECEIPT		
CustomerA	Dept. 1	\$1.00	1 00	1	1 DEPT01 .1.00
	Dept. 3	\$2.00	2 00	3	1 DEPT03 .2.00
CustomerB	Dept. 3	\$3.00		TRAY TOTAL	TRAY TL - 3.00
	Dept. 4	\$4.00	3 00	3	1 DEPT03 .3.00
Payment	Cash	\$10.00	4 00	4	1 DEPT04 .4.00
				TRAY TOTAL	TRAY TL - 7.00
				TRAY TOTAL	TL - 10.00
				CA/AMT /TEND	CASH -10.00

# Coupon transactions

Note that errors result when the result of a calculation is negative if the cash register is programmed to prohibit credit balances.

## Coupon registration using <COUPON> (coupon key)

### Example

			OPERATION	RECEIPT
Item 1	Dept. 1	\$3.00	<b>2</b> <input type="checkbox"/> DATE TIME	2 DEPT01            .6.00 CPN                 -1.00 1 DEPT03            4.00 CPN                 -1.00 TL                   - 8.00 CASH                 8.00
	Quantity	2	<b>3</b> <b>00</b> <b>1</b>	
	Coupon	\$0.50 × 2	<b>2</b> <input type="checkbox"/> DATE TIME	
Item 2	Dept. 3	\$4.00	<b>5</b> <b>0</b> CPN	
	Quantity	1	<b>4</b> <b>00</b> <b>3</b>	
	Coupon	(\$1.00)	CPN	
Payment	Cash	\$8.00	CA/AMT TEND	

- The model for the U.S./Canada, use  FOR DATE TIME instead of  DATE TIME.

## Coupon registration using <COUPON2> (coupon 2 key)

### Example

			OPERATION	RECEIPT
Item 1	Dept. 1	\$15.00	<b>1</b> <b>5</b> <b>00</b> <b>1</b>	1 DEPT01            15.00 CPN2                ..... 1 DEPT01            -1.50 1 PLU0010            5.00 CPN2                ..... 1 PLU0050            -0.50 TL                   - 18.00 CASH                 18.00
	Quantity	1	CPN2 <b>1</b> <b>5</b> <b>0</b> <b>1</b>	
	Coupon 2 Dept. 1	\$1.50	<b>1</b> <b>0</b> PLU	
Item 2	PLU 10	\$5.00	CPN2 <b>5</b> <b>0</b> PLU	
	Quantity	1		
	Coupon 2 PLU 50	(\$0.50)	CA/AMT TEND	
Payment	Cash	\$18.00		

## Registering the second unit price

Second unit prices along with quantity modifiers can be programmed to PLUs. Pressing <PRICE SHIFT> (price shift key) calls up the second unit price, quantity modifier, and descriptor. Totalizers and inventory are adjusted by multiplying the number of items being registered by the quantity modifier programmed to the PLU being registered.

- <PRICE SHIFT> must be pressed before each registration of a PLU.
- Second unit price registration is no available with open PLUs when unit price is not preset.
- Second unit prices and quantity modifiers are assigned to PLUs using programming procedures described in the dealer's manual.
- Even if a PLU is programmed with a package quantity, the second unit price and quantity modifier are applied during registration following operation of <PRICE SHIFT>.

### Example 1

OPERATION			RECEIPT									
Item 1	PLU 1 <sub>2nd@</sub>	(\$10.00)	<b>PRICE SHIFT</b> <b>1</b> <b>PLU</b>	<table border="1"> <tr><td>1 PLU0001</td><td>.10.00</td></tr> <tr><td>1 PLU0010</td><td>.5.00</td></tr> <tr><td>TL</td><td>- 15.00</td></tr> <tr><td>CASH</td><td>.15.00</td></tr> </table>	1 PLU0001	.10.00	1 PLU0010	.5.00	TL	- 15.00	CASH	.15.00
	1 PLU0001	.10.00										
	1 PLU0010	.5.00										
TL	- 15.00											
CASH	.15.00											
Quantity	1	The operation declares that the next input is a second unit price.										
Unit Q'ty	1											
Item 2	PLU 10 <sub>2nd@</sub>	(\$5.00)	<b>PRICE SHIFT</b> <b>1</b> <b>0</b> <b>PLU</b>									
	Quantity	1	<b>SUB TOTAL</b>									
	Unit Q'ty	1	<b>CA / AMT / TEND</b>									
Payment	Cash	\$15.00										

### Example 2

OPERATION			RECEIPT									
Item	PLU 2 <sub>2nd@</sub>	(\$10.00)	<b>5</b> <b>X / DATE TIME</b>	<table border="1"> <tr><td>5 PLU0001</td><td>.50.00</td></tr> <tr><td>TL</td><td>- 50.00</td></tr> <tr><td>CASH</td><td>.50.00</td></tr> <tr><td>CG</td><td>.0.00</td></tr> </table>	5 PLU0001	.50.00	TL	- 50.00	CASH	.50.00	CG	.0.00
	5 PLU0001	.50.00										
	TL	- 50.00										
CASH	.50.00											
CG	.0.00											
Quantity	5	<b>PRICE SHIFT</b> <b>2</b> <b>PLU</b>										
2nd Q'ty	3	<b>5</b> <b>0</b> <b>00</b> <b>CA / AMT / TEND</b>										
Payment	Cash	\$50.00										

- The model for the U.S./Canada, use **X / FOR DATE TIME** instead of **X / DATE TIME**.

### Example 3

The procedure shown above are for when the cash register is programmed not to maintain a second unit price shift. It is programmed is performed to maintain a second unit price shift, the following procedure applies.

OPERATION			RECEIPT													
Item 1	PLU 1 <sub>2nd@</sub>	(\$10.00)	<b>PRICE SHIFT</b> <b>1</b> <b>PLU</b>	<table border="1"> <tr><td>1 PLU0001</td><td>.10.00</td></tr> <tr><td>1 PLU0002</td><td>.5.00</td></tr> <tr><td>1 PLU0001</td><td>.1.00</td></tr> <tr><td>TL</td><td>- 16.00</td></tr> <tr><td>CASH</td><td>.16.00</td></tr> <tr><td>CG</td><td>.0.00</td></tr> </table>	1 PLU0001	.10.00	1 PLU0002	.5.00	1 PLU0001	.1.00	TL	- 16.00	CASH	.16.00	CG	.0.00
	1 PLU0001	.10.00														
	1 PLU0002	.5.00														
1 PLU0001	.1.00															
TL	- 16.00															
CASH	.16.00															
CG	.0.00															
Quantity	1	This operation shifts to registration of second unit price.														
Unit Q'ty	1	<b>2</b> <b>PLU</b>														
Item 2	PLU 2 <sub>2nd@</sub>	(\$5.00)	<b>PRICE SHIFT</b> <b>PRICE SHIFT</b> <b>1</b> <b>PLU</b>													
	Quantity	1	This operation shifts back to registration of normal (first) unit price.													
	Unit Q'ty	1	<b>1</b> <b>6</b> <b>00</b> <b>CA/AMT/TEND</b>													
Item 3	PLU 1	(\$1.00)														
	Quantity	1														
	Unit Q'ty	1														
Payment	Cash	\$16.00														

## Preset tender amount

An amount up to six digits long can be programmed to <CASH> (cash/amount tendered key). Then, when <CASH> is pressed without inputting a value, the programmed value is automatically registered and the transaction is finalized. When an amount is programmed to <CASH>, attempting to manually input an amount results in an error.

### Example 1

OPERATION			RECEIPT									
Item	Dept. 1	\$8.00	<b>8</b> <b>00</b> <b>1</b>	<table border="1"> <tr><td>1 DEPT01</td><td>.8.00</td></tr> <tr><td>TL</td><td>- 8.00</td></tr> <tr><td>CASH</td><td>.10.00</td></tr> <tr><td>CG</td><td>.2.00</td></tr> </table>	1 DEPT01	.8.00	TL	- 8.00	CASH	.10.00	CG	.2.00
	1 DEPT01	.8.00										
TL	- 8.00											
CASH	.10.00											
CG	.2.00											
Quantity	1	<b>CA/AMT/TEND</b>										
Payment	Cash	(\$10.00)	The preset amount is tendered.									

### Example 2

OPERATION			RECEIPT											
Item	Dept. 1	\$15.00	<b>1</b> <b>5</b> <b>00</b> <b>1</b>	<table border="1"> <tr><td>1 DEPT01</td><td>.15.00</td></tr> <tr><td>TL</td><td>- 15.00</td></tr> <tr><td>CHECK</td><td>.5.00</td></tr> <tr><td>CASH</td><td>.10.00</td></tr> <tr><td>CG</td><td>.0.00</td></tr> </table>	1 DEPT01	.15.00	TL	- 15.00	CHECK	.5.00	CASH	.10.00	CG	.0.00
	1 DEPT01	.15.00												
TL	- 15.00													
CHECK	.5.00													
CASH	.10.00													
CG	.0.00													
Quantity	1	<b>1</b> <b>0</b> <b>00</b> <b>CA/AMT/TEND</b>	An error occurs by manual input											
Payment	Cash	(\$10.00)	<b>C</b>											
	Check	\$5.00	<b>5</b> <b>00</b> <b>CHK/TEND</b>											
		<b>CA/AMT/TEND</b>												

## Bottle link operation

You can link PLU to a PLU.

### Example

OPERATION			RECEIPT		
Item 1	PLU 1	(\$8.00)	<b>1</b>	PLU	1 PLU0001           ·8.00 1 PLU0011           ·0.80 3 PLU0002           ·15.00 3 PLU0012           ·1.50 TL                   -25.30 CASH               ·30.00 CG                   ·4.70
	PLU 11 <sub>linked</sub>	(\$0.80)	<b>3</b>	<input checked="" type="checkbox"/> DATE TIME	
	Quantity	1	<b>2</b>	PLU	
Item 2	PLU 2	(\$5.00)	<b>3</b>	<b>0</b>	
	PLU 12 <sub>linked</sub>	(\$0.50)	<b>00</b>	CA/AMT TEND	
	Quantity	3			
Payment	Cash	\$30.00			

- The model for the U.S./Canada, use  FOR DATE TIME instead of  DATE TIME.

## Bottle returns

### Bottle return key

You can use the linked bottle return key to register a bottle return. A PLU whose programmed unit price represents the contents of the bottle, can be linked with PLU whose programmed unit price represents the deposit on the bottle. In the following example, the bottle return key has been programmed to operate as a linked bottle return key.

The bottle return key must be pressed before input of each new linked bottle return.

### Example

OPERATION			RECEIPT		
Return Item 1	PLU 1	(\$8.00)	<b>BR</b>	<b>1</b>	BR                   ..... 1 PLU0011           -0.80 BR                   ..... 3 PLU0012           -1.50 TL                   -2.30 CASH               -2.30
	PLU 11 <sub>linked</sub>	(\$0.80)	<b>3</b>	<input checked="" type="checkbox"/> DATE TIME	
	Quantity	1	<b>BR</b>	<b>2</b>	
Return Item 2	PLU 2	(\$5.00)			
	PLU 12 <sub>linked</sub>	(\$0.50)		CA/AMT TEND	
	Quantity	3			
Payment	Cash	\$2.30			

- The model for the U.S./Canada, use  FOR DATE TIME instead of  DATE TIME.



# Arrangement key registrations

Key operations can be assigned to an <ARRANGE> (arrangement key). Then, simply pressing <ARRANGE> performs all of the key functions assigned to it.

Key operations can also be assigned to an address code. Then, when you input the address code using <ARRANGE>, all of the key functions assigned to the address code are performed.

## Example 1

OPERATION			RECEIPT	
Arrangement 1			ARR	1 PLU0001 .8.00
Item 1	PLU 1	(\$8.00)		1 PLU0002 .5.00
	Quantity	1		TL - 13.00
Item 2	PLU 2	(\$5.00)		CASH .13.00
	Quantity	1		
Payment	Cash	\$13.00		

## Example 2

OPERATION			RECEIPT	
Arrangement 5			5 ARR	1 DEPT01 .1.00
Item 1	Dept 1	\$1.00		1 DEPT02 .2.00
	Quantity	1		TL - 3.00
Item 2	Dept 2	\$2.00		CASH .3.00
	Quantity	1		
Payment	Cash	\$3.00		

# Set menu

When you register a set menu, its total amount is added to the PLU totalizer and counter. The price of each set menu item is also added to each respective PLU totalizer and counter.

## Example

OPERATION			RECEIPT	
Set menu	PLU 35	\$5.00	3 5 PLU	1 PLU0035 .5.00
Item 1	PLU 1	--	CA/AMT TEND	PLU0001
	PLU 2	--		PLU0002
Item 2	PLU 3	--		PLU0003
	PLU 4	--		PLU0004
Payment	Cash	\$5.00		TL - 5.00
				CASH .5.00

## Currency exchange function

When <CE> (currency exchange key) is pressed, a current subtotal including tax is converted directly into foreign currency and the result is displayed, and the subsequent finalization is handled using the foreign currency. The currency exchange function is released by finalizing a transaction, partial tender operation, receipt issuance, or by pressing <SUBTOTAL>.



Before using the currency exchange function, it is necessary to program the conversion rate.









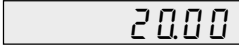

### Registering foreign currency

#### Full amount tender in foreign currency

\* Pre-programmed exchange rate: ¥ 100 = \$0.9524

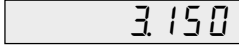
#### Important!

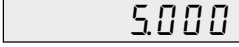
Tenders in a foreign currency can be registered using the  and  only. Other finalize keys cannot be used.

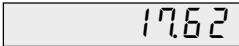
OPERATION	DISPLAY	RECEIPT														
<p><b>1 0 00</b>  ← Enter the unit price and press the applicable department key.</p>	<p> (Displays in \$)</p>	<table border="1"> <tr> <td>1 DEPT01</td> <td>· 10.00</td> </tr> <tr> <td>2 DEPT02</td> <td>· 20.00</td> </tr> <tr> <td>TL</td> <td>- 30.00</td> </tr> <tr> <td>CE</td> <td></td> </tr> <tr> <td>CASH</td> <td>¥5,000</td> </tr> <tr> <td>CASH</td> <td>· 47.62</td> </tr> <tr> <td>CG</td> <td>· 17.62</td> </tr> </table>	1 DEPT01	· 10.00	2 DEPT02	· 20.00	TL	- 30.00	CE		CASH	¥5,000	CASH	· 47.62	CG	· 17.62
1 DEPT01	· 10.00															
2 DEPT02	· 20.00															
TL	- 30.00															
CE																
CASH	¥5,000															
CASH	· 47.62															
CG	· 17.62															
<p><b>2 0 00</b>  ← Enter the next unit price and press the applicable department key.</p>	<p> (Displays in \$)</p>															
<p>  ← Press  and  without entering a numeric value. This operation converts the subtotal (including tax) dollar value into yen by applying a pre-programmed exchange rate. The result is shown on the display and printed on the receipt/journal by programming.</p>	<p> (Displays in ¥: 3,150)</p>															
<p><b>5 0 00</b>  ← Enter the amount tendered in yen and press . This operation converts the entered yen amount into dollars by applying a pre-programmed exchange rate. The result is shown on the display. (5,000)</p>	<p></p>															
<p> ← Press to finalize the transaction. Note that you do not need to reenter the dollar amount. The register automatically calculates the change amount due in dollars and shows it on the display, receipts and journal.</p>	<p> (Displays in \$)</p>															

## Partial tender in a foreign currency

\* Pre-programmed exchange rate: ¥ 100 = \$0.9524

### Important!

Partial tender in a foreign currency can be registered using **CA/AMT/TEND** and **CHK/TEND** only. Other finalization keys cannot be used, but the remaining tender can be finalized using any finalize key.

#### OPERATION

#### DISPLAY

#### RECEIPT

**1 0 00** **1**

← Enter the unit price and press the applicable department key.

**10.00**  
(Displays in \$)

**2 0 00** **2**

← Enter the next unit price and press the applicable department key.

**20.00**  
(Displays in \$)

**CE** **SUB/TOTAL**

← Press **CE** and **SUB/TOTAL** without entering a numeric value. This operation converts the subtotal (including tax) dollar value into yen by applying a pre-programmed exchange rate. The result is shown on the display and printed on the receipt/journal by programming.

**3.150**  
(Displays in ¥: 3,150)

**2 0 00** **CE**  
(2,000)

← Enter the partial amount tendered in yen and press **CE**. This operation converts the entered yen amount into dollars by applying a pre-programmed exchange rate. The result is shown on the display.

**2.000**

**CA/AMT/TEND**

← Press **CA/AMT/TEND** to specify cash tender for the yen partial tender. Note that you do not need to reenter the dollar amount. The register automatically deducts the dollar equivalent of the yen amount tendered from the total amount due and shows the amount on the display.

**10.95**  
(Displays in \$)

**CHK/TEND**

← Press to finalize the transaction.

**10.95**  
(Displays in \$)

1	DEPT01	· 10.00
1	DEPT02	· 20.00
	TL	- 30.00
	CE	
	CASH	¥2,000
	CASH	· 19.05
	CHK	· 10.95

## Food stamp function

### Food stamp registration

No change due



#### OPERATION

Item 1	Dept. 1	\$1.00
	Taxable	1, F/S
Item 2	Dept. 2	\$2.00
	Taxable	2
Item 3	Dept. 3	\$3.00
	Taxable	No → F/S
Payment	Food stamp	\$2.00
	Cash	\$4.14

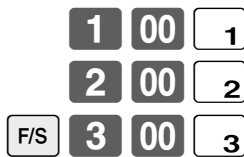

Shifting food stamp status, press **F/S** key.

**FS/ST**

Press **FS/ST**, at the top of the food stamp tender.



**CA/AMT/TEND**

#### RECEIPT

1 DEPT01	T1 F	\$1.00	
1 DEPT02	T2	\$2.00	
1 DEPT03	F	\$3.00	
TA1		\$1.00	
TX1		\$0.04	
TA2		\$2.00	
TX2		\$0.10	
TL		<b>\$6.14</b>	Subtotal
FSST		\$4.04	Food stamp subtotal
FSTD		\$2.00	Food stamp tendered
CASH		\$4.14	

## Mixed food stamp/cash change

### Example 1

OPERATION			RECEIPT		
Item 1	Dept. 1	\$1.00	<b>1 00</b>	<b>1</b>	1 DEPT01 T1 F \$1.00
	Taxable	1, F/S	<b>F/S 2 00</b>	<b>2</b>	1 DEPT02 T2 F \$2.00
Item 2	Dept. 2	\$2.00	<b>F/S 3 00</b>	<b>3</b>	1 DEPT03 F \$3.00
	Taxable	2, F/S			TA1 \$1.00
Item 3	Dept. 3	\$3.00			TX1 \$0.04
	Taxable	F/S			TA2 \$2.00
Payment	Food stamp	\$7.00			TX2 \$0.10
					TL <b>\$6.14</b> Subtotal
					FSST \$6.14 Food stamp subtotal
					FSTD \$7.00 Food stamp tendered
					CG \$0.86 Cash change

The change in food stamp transactions is automatically calculated as cash for amounts of \$1.00 or less, and as food stamps for amounts greater than \$1.00.

### Example 2

OPERATION			RECEIPT		
Item	Dept. 1	\$2.00	<b>2 00</b>	<b>1</b>	1 DEPT01 T1 F \$2.00
	Taxable	1, F/S			TA1 \$2.00
Payment	Food stamp	\$5.00			TX1 \$0.08
					TL <b>\$2.08</b>
					FSST \$2.08
					FSTD \$5.00
					FSCG \$2.00
					CG \$0.92

In the above example, the total amount of change due is \$2.92; \$2.00 in food stamps and \$0.92 in cash.

# Advanced Operations

## Mixed food stamp/cash change (continued...)

### Example 3

OPERATION			RECEIPT																													
Item 1	Dept. 1	\$2.00	2 00	1	<table border="0"> <tr><td>1 DEPT01</td><td>T1 F</td><td>\$1.00</td></tr> <tr><td>1 DEPT04</td><td></td><td>\$0.50</td></tr> <tr><td>TA1</td><td></td><td>\$2.00</td></tr> <tr><td>TX1</td><td></td><td>\$0.08</td></tr> <tr><td>TL</td><td></td><td><b>\$2.58</b></td></tr> <tr><td>FSST</td><td></td><td>\$2.08</td></tr> <tr><td>FSTD</td><td></td><td>\$5.00</td></tr> <tr><td>FSCG</td><td></td><td>\$2.00</td></tr> <tr><td>CG</td><td></td><td>\$0.42</td></tr> </table>	1 DEPT01	T1 F	\$1.00	1 DEPT04		\$0.50	TA1		\$2.00	TX1		\$0.08	TL		<b>\$2.58</b>	FSST		\$2.08	FSTD		\$5.00	FSCG		\$2.00	CG		\$0.42
	1 DEPT01	T1 F	\$1.00																													
1 DEPT04		\$0.50																														
TA1		\$2.00																														
TX1		\$0.08																														
TL		<b>\$2.58</b>																														
FSST		\$2.08																														
FSTD		\$5.00																														
FSCG		\$2.00																														
CG		\$0.42																														
Taxable	1, F/S		5 0	4																												
Item 2	Dept. 4	\$0.50		FS/ST																												
	Taxable	No	5 00	FS/TD																												
Payment	Food stamp	\$5.00																														

When food stamp items are included in a transaction, the amount of change due in cash is applied as a cash amount tendered for cash (nonfood stamp) items. In this example, the \$0.50 purchased (department 4) is automatically deducted from the \$0.92 cash due in change from the food stamp purchase (department 4).

### Example 4

OPERATION			RECEIPT																																						
Item 1	Dept. 1	\$1.00	1 00	1	<table border="0"> <tr><td>1 DEPT01</td><td>T1 F</td><td>\$1.00</td></tr> <tr><td>1 DEPT02</td><td>T2</td><td>\$2.00</td></tr> <tr><td>1 DEPT03</td><td></td><td>\$3.00</td></tr> <tr><td>TA1</td><td></td><td>\$1.00</td></tr> <tr><td>TX1</td><td></td><td>\$0.04</td></tr> <tr><td>TA2</td><td></td><td>\$2.00</td></tr> <tr><td>TX2</td><td></td><td>\$0.10</td></tr> <tr><td>TL</td><td></td><td><b>\$6.14</b></td></tr> <tr><td>FSST</td><td></td><td>\$1.04</td></tr> <tr><td>FSTD</td><td></td><td>\$5.00</td></tr> <tr><td>FSCG</td><td></td><td>\$3.00</td></tr> <tr><td>CASH</td><td></td><td>\$4.14</td></tr> </table>	1 DEPT01	T1 F	\$1.00	1 DEPT02	T2	\$2.00	1 DEPT03		\$3.00	TA1		\$1.00	TX1		\$0.04	TA2		\$2.00	TX2		\$0.10	TL		<b>\$6.14</b>	FSST		\$1.04	FSTD		\$5.00	FSCG		\$3.00	CASH		\$4.14
	1 DEPT01	T1 F	\$1.00																																						
1 DEPT02	T2	\$2.00																																							
1 DEPT03		\$3.00																																							
TA1		\$1.00																																							
TX1		\$0.04																																							
TA2		\$2.00																																							
TX2		\$0.10																																							
TL		<b>\$6.14</b>																																							
FSST		\$1.04																																							
FSTD		\$5.00																																							
FSCG		\$3.00																																							
CASH		\$4.14																																							
Taxable	1, F/S		2 00	2																																					
Item 2	Dept. 2	\$2.00	3 00	3																																					
	Taxable	2		FS/ST																																					
Item 3	Dept. 3	\$3.00	5 00	FS/TD																																					
	Taxable	No		CA/AMT/TEND																																					
Payment	Food stamp	\$5.00																																							
	Cash	\$4.14																																							

The following calculation is performed internally to apply the cash change due on the food stamp transaction to the balance due of the cash transaction.

	Food stamp transaction	Cash transaction
Price items:	\$1.00	\$5.00
Tax:	\$0.04	\$0.10
Total due:	\$1.04	\$5.10
Amount tendered:	\$5.00 (food stamp)	\$4.14 (cash), \$0.96 (change from food stamp)
Amount due:	\$1.04	
Change amount due:	\$3.00 (food stamp), \$0.96 (cash)	
Total:		\$5.10

## Food stamp registration (Illinois rule)

### No change due

#### Example 1

			OPERATION	RECEIPT																		
Item 1	Dept. 1	\$1.00	<b>1</b> <b>00</b> <b>1</b>	<table border="1"> <tr><td>1 DEPT01</td><td>T1 F</td><td>\$1.00</td></tr> <tr><td>1 DEPT01</td><td>T1 F</td><td>\$2.00</td></tr> <tr><td>1 DEPT04</td><td>F</td><td>\$3.00</td></tr> <tr><td>TL</td><td></td><td><b>\$6.00</b></td></tr> <tr><td>FSST</td><td></td><td>\$6.00</td></tr> <tr><td>FSTD</td><td></td><td>\$6.00</td></tr> </table>	1 DEPT01	T1 F	\$1.00	1 DEPT01	T1 F	\$2.00	1 DEPT04	F	\$3.00	TL		<b>\$6.00</b>	FSST		\$6.00	FSTD		\$6.00
	1 DEPT01	T1 F	\$1.00																			
1 DEPT01	T1 F	\$2.00																				
1 DEPT04	F	\$3.00																				
TL		<b>\$6.00</b>																				
FSST		\$6.00																				
FSTD		\$6.00																				
Taxable	1, F/S		<b>2</b> <b>00</b> <b>1</b>																			
Item 2	Dept. 1	\$2.00	<b>3</b> <b>00</b> <b>4</b>																			
	Taxable	1, F/S	FS/ST																			
Item 3	Dept. 4	\$3.00	<b>6</b> <b>00</b> FS/TD																			
	Taxable	F/S																				
Payment	Food stamp	\$6.00																				

#### Example 2

			OPERATION	RECEIPT																								
Item 1	Dept. 1	\$2.00	<b>2</b> <b>00</b> <b>1</b>	<table border="1"> <tr><td>1 DEPT01</td><td>T1 F</td><td>\$2.00</td></tr> <tr><td>1 DEPT01</td><td>T1 F</td><td>\$3.00</td></tr> <tr><td>1 DEPT04</td><td>T1 F</td><td>\$4.00</td></tr> <tr><td>FSST</td><td></td><td>\$9.00</td></tr> <tr><td>FSTD</td><td></td><td>\$5.00</td></tr> <tr><td>TA1</td><td></td><td>\$4.00</td></tr> <tr><td>TX1</td><td></td><td>\$0.16</td></tr> <tr><td>CASH</td><td></td><td>\$4.16</td></tr> </table>	1 DEPT01	T1 F	\$2.00	1 DEPT01	T1 F	\$3.00	1 DEPT04	T1 F	\$4.00	FSST		\$9.00	FSTD		\$5.00	TA1		\$4.00	TX1		\$0.16	CASH		\$4.16
	1 DEPT01	T1 F	\$2.00																									
1 DEPT01	T1 F	\$3.00																										
1 DEPT04	T1 F	\$4.00																										
FSST		\$9.00																										
FSTD		\$5.00																										
TA1		\$4.00																										
TX1		\$0.16																										
CASH		\$4.16																										
Taxable	1, F/S		<b>3</b> <b>00</b> <b>1</b>																									
Item 2	Dept. 1	\$3.00	<b>4</b> <b>00</b> <b>4</b>																									
	Taxable	1, F/S	FS/ST																									
Item 3	Dept. 4	\$4.00	<b>5</b> <b>00</b> FS/TD																									
	Taxable	1, F/S																										
Payment	Food stamp	\$5.00	CA/AMT /TEND																									
	Cash	\$4.16																										

# Advanced Operations

## No change due (continued...)

### Example 3

			OPERATION	RECEIPT																																				
Item 1	Dept. 1	\$2.00	<b>2</b> <b>00</b> <b>1</b>	<table border="1"> <tr><td>1</td><td>DEPT01</td><td>T1 F</td><td>\$2.00</td></tr> <tr><td>1</td><td>DEPT02</td><td>T2 F</td><td>\$3.00</td></tr> <tr><td></td><td>FSST</td><td></td><td>\$5.00</td></tr> <tr><td></td><td>FSTD</td><td></td><td>\$1.00</td></tr> <tr><td></td><td>TA1</td><td></td><td>\$1.00</td></tr> <tr><td></td><td>TX1</td><td></td><td>\$0.04</td></tr> <tr><td></td><td>TA2</td><td></td><td>\$3.00</td></tr> <tr><td></td><td>TX2</td><td></td><td>\$0.15</td></tr> <tr><td></td><td>CASH</td><td></td><td>\$4.19</td></tr> </table>	1	DEPT01	T1 F	\$2.00	1	DEPT02	T2 F	\$3.00		FSST		\$5.00		FSTD		\$1.00		TA1		\$1.00		TX1		\$0.04		TA2		\$3.00		TX2		\$0.15		CASH		\$4.19
	1	DEPT01	T1 F		\$2.00																																			
1	DEPT02	T2 F	\$3.00																																					
	FSST		\$5.00																																					
	FSTD		\$1.00																																					
	TA1		\$1.00																																					
	TX1		\$0.04																																					
	TA2		\$3.00																																					
	TX2		\$0.15																																					
	CASH		\$4.19																																					
	Taxable	1, F/S	<b>3</b> <b>00</b> <b>2</b>																																					
Item 2	Dept. 2	\$3.00	<b>FS/ST</b>																																					
	Taxable	2, F/S	<b>1</b> <b>00</b> <b>FS/TD</b>																																					
Payment	Food stamp	\$1.00	<b>CA/AMT/TEND</b>																																					
	Cash	\$4.19																																						

In this case, the result of the taxable 1 amount is \$1.00 (2.00 - 1.00), the taxable 2 amount is \$3.00.

### Example 4

			OPERATION	RECEIPT																												
Item 1	Dept. 1	\$1.00	<b>1</b> <b>00</b> <b>1</b>	<table border="1"> <tr><td>1</td><td>DEPT01</td><td>T1 F</td><td>\$1.00</td></tr> <tr><td>1</td><td>DEPT02</td><td>T2 F</td><td>\$5.00</td></tr> <tr><td></td><td>FSST</td><td></td><td>\$6.00</td></tr> <tr><td></td><td>FSTD</td><td></td><td>\$4.00</td></tr> <tr><td></td><td>TA2</td><td></td><td>\$2.00</td></tr> <tr><td></td><td>TX2</td><td></td><td>\$0.10</td></tr> <tr><td></td><td>CASH</td><td></td><td>\$2.10</td></tr> </table>	1	DEPT01	T1 F	\$1.00	1	DEPT02	T2 F	\$5.00		FSST		\$6.00		FSTD		\$4.00		TA2		\$2.00		TX2		\$0.10		CASH		\$2.10
	1	DEPT01	T1 F		\$1.00																											
1	DEPT02	T2 F	\$5.00																													
	FSST		\$6.00																													
	FSTD		\$4.00																													
	TA2		\$2.00																													
	TX2		\$0.10																													
	CASH		\$2.10																													
	Taxable	1, F/S	<b>5</b> <b>00</b> <b>2</b>																													
Item 2	Dept. 2	\$5.00	<b>FS/ST</b>																													
	Taxable	2, F/S	<b>4</b> <b>00</b> <b>FS/TD</b>																													
Payment	Food stamp	\$4.00	<b>CA/AMT/TEND</b>																													
	Cash	\$2.10																														

In this case, the result of the taxable 1 amount is \$0.00 (1.00 - 1.00), the taxable 2 amount is \$2.00 (5.00 - (3.00 - 1.00)).



## Mixed food stamp/cash change

### Example 1

			OPERATION	RECEIPT																								
Item 1	Dept. 1	\$1.50	<b>1 5 0</b> <input type="text" value="1"/>	<table border="1"> <tr> <td>1 DEPT01</td> <td>T1 F</td> <td>\$1.50</td> </tr> <tr> <td>1 DEPT01</td> <td>T1 F</td> <td>\$2.00</td> </tr> <tr> <td>1 DEPT04</td> <td>F</td> <td>\$3.00</td> </tr> <tr> <td>TL</td> <td></td> <td><b>\$6.50</b></td> </tr> <tr> <td>FSST</td> <td></td> <td>\$6.50</td> </tr> <tr> <td>FSTD</td> <td></td> <td>\$10.00</td> </tr> <tr> <td>FSCG</td> <td></td> <td>\$3.00</td> </tr> <tr> <td>CG</td> <td></td> <td>\$0.50</td> </tr> </table>	1 DEPT01	T1 F	\$1.50	1 DEPT01	T1 F	\$2.00	1 DEPT04	F	\$3.00	TL		<b>\$6.50</b>	FSST		\$6.50	FSTD		\$10.00	FSCG		\$3.00	CG		\$0.50
	1 DEPT01	T1 F	\$1.50																									
1 DEPT01	T1 F	\$2.00																										
1 DEPT04	F	\$3.00																										
TL		<b>\$6.50</b>																										
FSST		\$6.50																										
FSTD		\$10.00																										
FSCG		\$3.00																										
CG		\$0.50																										
Taxable	1, F/S		<b>2 00</b> <input type="text" value="1"/>																									
Item 2	Dept. 1	\$2.00	<b>3 00</b> <input type="text" value="4"/>																									
	Taxable	1, F/S	<input type="text" value="FS/ST"/>																									
Item 3	Dept. 4	\$3.00	<b>1 0 00</b> <input type="text" value="FS/TD"/>																									
	Taxable	F/S																										
Payment	Food stamp	\$10.00																										

The change in food stamp transactions is automatically calculated as cash for amount of \$1.00 or less, and as food stamps for amounts greater than \$1.00. In the above example, the total amount of change due is \$3.50 (\$3.00 in food stamps and \$0.50 in cash).

### Example 2

			OPERATION	RECEIPT															
Item	Dept. 1	\$2.00	<b>2 00</b> <input type="text" value="1"/>	<table border="1"> <tr> <td>1 DEPT01</td> <td>T1 F</td> <td>\$2.00</td> </tr> <tr> <td>TL</td> <td></td> <td><b>\$2.00</b></td> </tr> <tr> <td>FSST</td> <td></td> <td>\$2.00</td> </tr> <tr> <td>FSTD</td> <td></td> <td>\$5.00</td> </tr> <tr> <td>FSCG</td> <td></td> <td>\$3.00</td> </tr> </table>	1 DEPT01	T1 F	\$2.00	TL		<b>\$2.00</b>	FSST		\$2.00	FSTD		\$5.00	FSCG		\$3.00
	1 DEPT01	T1 F	\$2.00																
TL		<b>\$2.00</b>																	
FSST		\$2.00																	
FSTD		\$5.00																	
FSCG		\$3.00																	
Taxable	1, F/S		<input type="text" value="FS/ST"/>																
Payment	Food stamp	\$5.00	<b>5 00</b> <input type="text" value="FS/TD"/>																

# Advanced Operations

## Mixed food stamp/cash change (continued...)

### Example 3

			OPERATION	RECEIPT																														
Item 1	Dept. 1	\$2.00	2 00 1	<table border="1"> <tr><td>1 DEPT01</td><td>T1 F</td><td>\$2.00</td></tr> <tr><td>1 DEPT01</td><td>T1 F</td><td>\$1.20</td></tr> <tr><td>1 DEPT03</td><td>T1</td><td>\$0.30</td></tr> <tr><td>TA1</td><td></td><td>\$0.30</td></tr> <tr><td>TX1</td><td></td><td>\$0.01</td></tr> <tr><td>TL</td><td></td><td>\$3.51</td></tr> <tr><td>FSST</td><td></td><td>\$3.20</td></tr> <tr><td>FSTD</td><td></td><td>\$5.00</td></tr> <tr><td>FSCG</td><td></td><td>\$1.00</td></tr> <tr><td>C6</td><td></td><td>\$0.49</td></tr> </table>	1 DEPT01	T1 F	\$2.00	1 DEPT01	T1 F	\$1.20	1 DEPT03	T1	\$0.30	TA1		\$0.30	TX1		\$0.01	TL		\$3.51	FSST		\$3.20	FSTD		\$5.00	FSCG		\$1.00	C6		\$0.49
	1 DEPT01	T1 F	\$2.00																															
1 DEPT01	T1 F	\$1.20																																
1 DEPT03	T1	\$0.30																																
TA1		\$0.30																																
TX1		\$0.01																																
TL		\$3.51																																
FSST		\$3.20																																
FSTD		\$5.00																																
FSCG		\$1.00																																
C6		\$0.49																																
	Taxable	1, F/S	1 2 0 1																															
Item 2	Dept. 1	\$1.20	3 0 3																															
	Taxable	1, F/S	FS/ST																															
Item 3	Dept. 3	\$0.30	5 00 FS/TD																															
	Taxable	1																																
Payment	Food stamp	\$5.00																																

When food stamp items are included in a transaction, the amount of change due in cash is applied as a cash amount tendered for cash (nonfood stamp) items. In this example, the \$0.30 purchase is automatically deducted from the \$0.80 cash due in change from the food stamp purchase.

### Example 4

			OPERATION	RECEIPT																					
Item 1	Dept. 1	\$1.00	1 00 1	<table border="1"> <tr><td>1 DEPT01</td><td>T1 F</td><td>\$1.00</td></tr> <tr><td>1 DEPT01</td><td>T1 F</td><td>\$2.50</td></tr> <tr><td>1 DEPT03</td><td></td><td>\$5.00</td></tr> <tr><td>FSST</td><td></td><td>\$3.50</td></tr> <tr><td>FSTD</td><td></td><td>\$5.00</td></tr> <tr><td>FSCG</td><td></td><td>\$1.00</td></tr> <tr><td>CASH</td><td></td><td>\$4.50</td></tr> </table>	1 DEPT01	T1 F	\$1.00	1 DEPT01	T1 F	\$2.50	1 DEPT03		\$5.00	FSST		\$3.50	FSTD		\$5.00	FSCG		\$1.00	CASH		\$4.50
	1 DEPT01	T1 F	\$1.00																						
1 DEPT01	T1 F	\$2.50																							
1 DEPT03		\$5.00																							
FSST		\$3.50																							
FSTD		\$5.00																							
FSCG		\$1.00																							
CASH		\$4.50																							
	Taxable	1, F/S	2 5 0 1																						
Item 2	Dept. 1	\$2.50	5 00 3																						
	Taxable	1, F/S	FS/ST																						
Item 3	Dept. 3	\$5.00	5 00 FS/TD																						
	Taxable	No																							
Payment	Food stamp	\$5.00	CA/AMT/TEND																						
	Cash	\$4.50																							

The following calculation is performed internally to apply the cash change due on the food stamp transaction to the balance due of the cash transaction.

	Food stamp transaction	Cash transaction
Price items:	\$3.50	\$5.00
Tax:	\$0.00	\$0.00
Total due:	\$3.50	\$5.00
Amount tendered:	\$5.00 (food stamp)	\$4.50 (cash), \$0.50 (change from food stamp)
Amount due:	\$3.50	
Change amount due:	\$1.00 (food stamp), \$0.50 (cash)	
Total:		\$5.00

## Electronic benefits transfer

In addition to standard food stamp tender finalizations, this model also allows finalization for tenders electronic benefits transfer (EBT) card.

EBT tenders can be accepted for New Jersey rule or Illinois rule food stamp tenders, as well as for food stamp tenders that do not follow these rules.

### About mixed EBT card tenders

When the register is programmed to prohibit an EBT amount tendered that exceeds the food stamp subtotal, nonfood stamp items cannot be paid for using an EBT card. In this case, the following applies:

- $ST - (EBT/TEND - FS/ST) = \text{Balance due}$  (the remaining balance due must be finalized using another finalize key.)

When the register is programmed to allow an EBT amount tendered that exceeds the food stamp subtotal, nonfood stamp items can be paid for using an EBT card. In this case, there are two possible situations:

- $ST > EBT/TEND$   
 $ST - (EBT/TEND - FS/ST) = \text{Balance due}$  (the remaining balance due must be finalized using another finalize key.)
- $EBT/TEND \geq ST$   
 $EBT/TEND - ST = \text{cash change}$

### No change due

#### Example 1

OPERATION			RECEIPT																		
Item 1	Dept. 1	\$1.00	<table style="width: 100%; border-collapse: collapse;"> <tr><td>1 DEPT01</td><td>T1 F</td><td>\$1.00</td></tr> <tr><td>1 DEPT02</td><td>T2 F</td><td>\$2.00</td></tr> <tr><td>1 DEPT03</td><td>F</td><td>\$2.00</td></tr> <tr><td>TL</td><td></td><td><b>\$6.00</b></td></tr> <tr><td>FSST</td><td></td><td>\$6.00</td></tr> <tr><td>EBTTD</td><td></td><td>\$6.00</td></tr> </table>	1 DEPT01	T1 F	\$1.00	1 DEPT02	T2 F	\$2.00	1 DEPT03	F	\$2.00	TL		<b>\$6.00</b>	FSST		\$6.00	EBTTD		\$6.00
	1 DEPT01	T1 F		\$1.00																	
1 DEPT02	T2 F	\$2.00																			
1 DEPT03	F	\$2.00																			
TL		<b>\$6.00</b>																			
FSST		\$6.00																			
EBTTD		\$6.00																			
Taxable	1, F/S																				
Item 2	Dept. 2	\$2.00																			
	Taxable	2, F/S																			
Item 3	Dept. 3	\$3.00																			
	Taxable	F/S																			
Payment	EBT	\$6.00																			

1	00	1
2	00	2
3	00	3
		FS/ST
6	00	EBT

# Advanced Operations

## Example 2

OPERATION			RECEIPT																												
Item 1	Dept. 1	\$1.00	<b>1</b> <b>00</b> <b>1</b>	<table style="width: 100%; border-collapse: collapse;"> <tr><td>1 DEPT01</td><td>T1 F</td><td>\$1.00</td></tr> <tr><td>1 DEPT02</td><td>T1 F</td><td>\$2.00</td></tr> <tr><td>1 DEPT03</td><td>T1</td><td>\$3.00</td></tr> <tr><td>FSST</td><td></td><td>\$3.00</td></tr> <tr><td>EBTTD</td><td></td><td>\$5.00</td></tr> <tr><td>TA1</td><td></td><td>\$3.00</td></tr> <tr><td>TX1</td><td></td><td>\$0.12</td></tr> <tr><td>CASH</td><td></td><td>\$1.12</td></tr> </table>	1 DEPT01	T1 F	\$1.00	1 DEPT02	T1 F	\$2.00	1 DEPT03	T1	\$3.00	FSST		\$3.00	EBTTD		\$5.00	TA1		\$3.00	TX1		\$0.12	CASH		\$1.12	Taxable	1, F/S	<b>2</b> <b>00</b> <b>2</b>
	1 DEPT01	T1 F	\$1.00																												
1 DEPT02	T1 F	\$2.00																													
1 DEPT03	T1	\$3.00																													
FSST		\$3.00																													
EBTTD		\$5.00																													
TA1		\$3.00																													
TX1		\$0.12																													
CASH		\$1.12																													
Item 2	Dept. 2	\$2.00	<b>3</b> <b>00</b> <b>3</b>																												
	Taxable	1, F/S	<b>FS/ST</b>																												
Item 3	Dept. 3	\$3.00	<b>5</b> <b>00</b> <b>EBT</b>																												
	Taxable	1	<b>CA/AMT/TEND</b>																												
Payment	EBT	\$5.00																													
	Cash	\$1.12																													

## Change due

OPERATION			RECEIPT																															
Item 1	Dept. 1	\$1.00	<b>1</b> <b>00</b> <b>1</b>	<table style="width: 100%; border-collapse: collapse;"> <tr><td>1 DEPT01</td><td>T1 F</td><td>\$1.00</td></tr> <tr><td>1 DEPT02</td><td>T1 F</td><td>\$1.20</td></tr> <tr><td>1 DEPT03</td><td>T1</td><td>\$0.30</td></tr> <tr><td>TA1</td><td></td><td>\$0.30</td></tr> <tr><td>TX1</td><td></td><td>\$0.01</td></tr> <tr><td>TL</td><td></td><td>\$2.51</td></tr> <tr><td>FSST</td><td></td><td>\$2.20</td></tr> <tr><td>EBTTD</td><td></td><td>\$5.00</td></tr> <tr><td>CG</td><td></td><td>\$2.49</td></tr> </table>	1 DEPT01	T1 F	\$1.00	1 DEPT02	T1 F	\$1.20	1 DEPT03	T1	\$0.30	TA1		\$0.30	TX1		\$0.01	TL		\$2.51	FSST		\$2.20	EBTTD		\$5.00	CG		\$2.49	Taxable	1, F/S	<b>1</b> <b>2</b> <b>0</b> <b>2</b>
	1 DEPT01	T1 F	\$1.00																															
1 DEPT02	T1 F	\$1.20																																
1 DEPT03	T1	\$0.30																																
TA1		\$0.30																																
TX1		\$0.01																																
TL		\$2.51																																
FSST		\$2.20																																
EBTTD		\$5.00																																
CG		\$2.49																																
Item 2	Dept. 2	\$1.20	<b>3</b> <b>0</b> <b>3</b>																															
	Taxable	1, F/S	<b>FS/ST</b>																															
Item 3	Dept. 3	\$0.30	<b>5</b> <b>00</b> <b>EBT</b>																															
	Taxable	1																																
Payment	EBT	\$5.00																																

## Tips

### Example

OPERATION			RECEIPT																						
Item 1	Unit price	\$3.00	<b>3</b> <b>00</b> <b>1</b>	<table style="width: 100%; border-collapse: collapse;"> <tr><td>1 DEPT01</td><td></td><td>-3.00</td></tr> <tr><td>1 DEPT02</td><td></td><td>-5.00</td></tr> <tr><td>TIP</td><td></td><td>-0.80</td></tr> <tr><td>TL</td><td></td><td>\$8.80</td></tr> <tr><td>CASH</td><td></td><td>\$10.00</td></tr> <tr><td>CG</td><td></td><td>\$1.20</td></tr> </table>	1 DEPT01		-3.00	1 DEPT02		-5.00	TIP		-0.80	TL		\$8.80	CASH		\$10.00	CG		\$1.20	Dept.	1	<b>5</b> <b>00</b> <b>2</b>
	1 DEPT01		-3.00																						
1 DEPT02		-5.00																							
TIP		-0.80																							
TL		\$8.80																							
CASH		\$10.00																							
CG		\$1.20																							
Item 2	Unit price	\$5.00	<b>SUB TOTAL</b>																						
	Dept.	2	<b>8</b> <b>0</b> <b>TIP</b>																						
Tip	Amount	\$0.80	<b>1</b> <b>0</b> <b>00</b> <b>CA/AMT/TEND</b>																						
Payment	Cash	\$10.00																							

# Inputting the number of customers

## Example 1

OPERATION			RECEIPT									
Item 1	Unit price	\$15.00	1	5	00	1	CST	2	CST	CT	2	
	Dept.	1										
Item 2	Unit price	\$5.00	5	00	2	SUB TOTAL	CA/AMT/TEND	2	SUB TOTAL	1 DEPT01	15.00	
	Dept.	2										
Customer	Number	2							TL	- 20.00	CASH	20.00
Payment	Cash	\$20.00										

## Example 2

You can only use the following operation to re-input the number of customers when <CUSTOMER> (customer number key) is preset to allow re-input. When programming prohibits re-input of the number of customers, this operation causes an error.

OPERATION			RECEIPT								
1	5	00	1	CST	3	CST	CT	3	1 DEPT01	15.00	
											5
								TL	- 20.00	CASH	20.00

You can re-input the number of customers either immediately after the initial input or during later registration.

## Example 3

You can use the following operation to add customers to an original number of customers input (when addition to the number of the customer is allowed).

OPERATION			RECEIPT								
1	5	00	1	CST	3	CST	CT	3	1 DEPT01	15.00	
											5
								TL	- 20.00	CASH	20.00

# Advanced Operations

## Text recall

This procedure is used to recall text by inputting the address where the text is stored. The recalled text is printed on the receipt and journal.

### Example

OPERATION			RECEIPT															
Item 1	Unit price	\$46.00	<b>4 6 00</b>	<table border="1"> <tr><td>CT</td><td>3</td></tr> <tr><td>1 DEPT01</td><td>-46.00</td></tr> <tr><td>MEDIUM SIZE</td><td></td></tr> <tr><td>1 DEPT02</td><td>-10.00</td></tr> <tr><td>SMALL SIZE</td><td></td></tr> <tr><td>TL</td><td>-56.00</td></tr> <tr><td>CASH</td><td>-56.00</td></tr> </table>	CT	3	1 DEPT01	-46.00	MEDIUM SIZE		1 DEPT02	-10.00	SMALL SIZE		TL	-56.00	CASH	-56.00
	CT	3																
1 DEPT01	-46.00																	
MEDIUM SIZE																		
1 DEPT02	-10.00																	
SMALL SIZE																		
TL	-56.00																	
CASH	-56.00																	
Dept.	1	<b>1</b>	<b>1</b> TEXT RECALL															
Item 2	Unit price	\$10.00	<b>1 0 00</b>															
	Dept.	2	<b>2</b>	<b>2</b> TEXT RECALL														
Payment	Cash	\$56.00		SUB TOTAL														
Text 1	MEDIUM SIZE			CA/AMT /TEND														
Text 2	SMALL SIZE																	

## Temporarily releasing compulsion

<OPEN 2> (open 2 key) can be programmed to release specific compulsion.

### Example 1

OPERATION			RECEIPT							
Item	Unit price	\$10.00	<b>1 0 00</b>	<table border="1"> <tr><td>1 DEPT01</td><td>-10.00</td></tr> <tr><td>TL</td><td>-10.00</td></tr> <tr><td>CHECK</td><td>-10.00</td></tr> </table>	1 DEPT01	-10.00	TL	-10.00	CHECK	-10.00
	1 DEPT01	-10.00								
TL	-10.00									
CHECK	-10.00									
Dept.	1	<b>1</b>	<b>1</b> 0 00 CHK/ TEND							
Payment	Check	\$10.00								
Validation compulsory			<b>2 00</b>	<b>2</b>						
			Validation compulsory							
			<b>OPEN</b> <b>2</b>	Validation compulsory is temporarily released.						

### Example 2

OPERATION			RECEIPT							
Input customer No. compulsory			<b>1 0 00</b>	<table border="1"> <tr><td>1 DEPT01</td><td>-10.00</td></tr> <tr><td>TL</td><td>-10.00</td></tr> <tr><td>CHECK</td><td>-10.00</td></tr> </table>	1 DEPT01	-10.00	TL	-10.00	CHECK	-10.00
1 DEPT01	-10.00									
TL	-10.00									
CHECK	-10.00									
Item	Unit price	\$10.00	Input customer No. compulsory							
	Dept.	1	<b>OPEN</b> <b>2</b>	Compulsory is temporarily released.						
Payment	Check	\$10.00	<b>1 0 00</b>							
			<b>1 0 00</b>							
			<b>1 0 00</b>							
			<b>CHK/</b> <b>TEND</b>							

---

## Printing slip

To perform batch printing on the slip printer, you must first use the memory allocation operation (see program 5 mode in the dealer's manual) to reserve slip buffer memory. The capacity of the slip buffer memory is determined by the number of units of slip buffer memory reserved by the memory allocation operation.

The register can be programmed to check the status of the registration buffer memory whenever slip batch printing is performed, and sound an alarm when the buffer memory is almost full. The alarm sounds when there are 12 lines or less remaining, and once it starts to sound, the only operation you can perform is the cancel operation or operations using one of the following keys.

- <CA/AMT TEND> (cash/amount tendered key) operation
- <CH> (charge key) operation
- <CHK/TEND> (check tendered key) operation
- <DEPOSIT> (deposit key) operation
- <NEW BALANCE> (new balance key) operation
- <SUBTOTAL> (subtotal key) operation

You must perform one of above operations when the registration buffer alarm sounds. Any other operations results in an error.

## Printing slips

The cash register can be connected to the optional SP-1300 slip printer, which features an automatic feed function and automatic back feed function.

### • Automatic feed function

This function makes it possible to program the number of line feeds that should be inserted from the normal print start position before starting slip printing of a new slip. Even if line feeds are programmed for this function, they are not inserted for validation printing, check endorsement printing, and check printing performed using the slip printer. Note also that line feeds are not inserted automatically at the beginning of a second slip when the transaction requires printing that extends from one slip to another.

### • Automatic back feed function

This function performs automatic back feed following slip printing, validation printing, and endorsement printing on the slip printer. The slip paper is released once the back feed operation is complete.

### • Manual feed function

<SLIP FEED/RELEASE> (slip feed/release key: assigned to the register's keyboard using the program 4 mode) can be used for manual feed of the slip paper. You perform manual feed by inputting a value for the number of lines (up to two digits in the range of 1 to 99) and then press <SLIP FEED/RELEASE>.

### • Manual back feed function

<SLIP BACK FEED/RELEASE> (slip back feed/release key: assigned to the register's keyboard using the program 4 mode) can be used for manual back feed of the slip paper. Manual back feed can be performed by inputting a value for the number of lines (up to two digits in the range of 1 to 99) and then press <SLIP BACK FEED/RELEASE>.

You can print slips using automatic or manual batch printing. The slip print operation can be performed in REG1, REG2, and RF modes only.

Finalizing a registration without inserting a slip paper into the slip printer when the register is programmed as "slip paper insertion into slip printer compulsory before finalizing registration" produces an error.

# Advanced Operations

## To perform auto batch printing 1

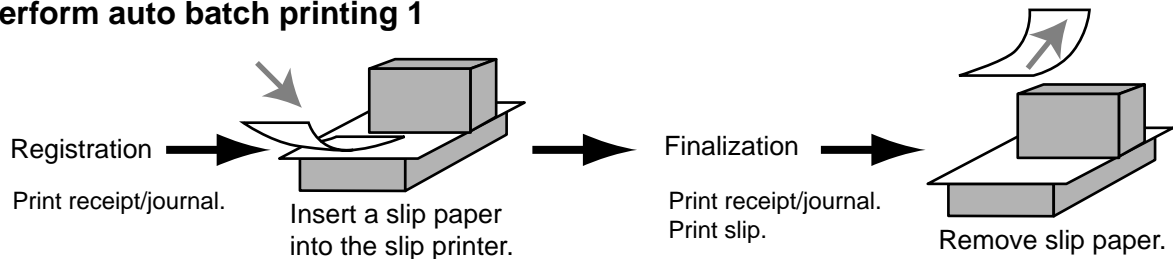

## To perform auto batch printing 2

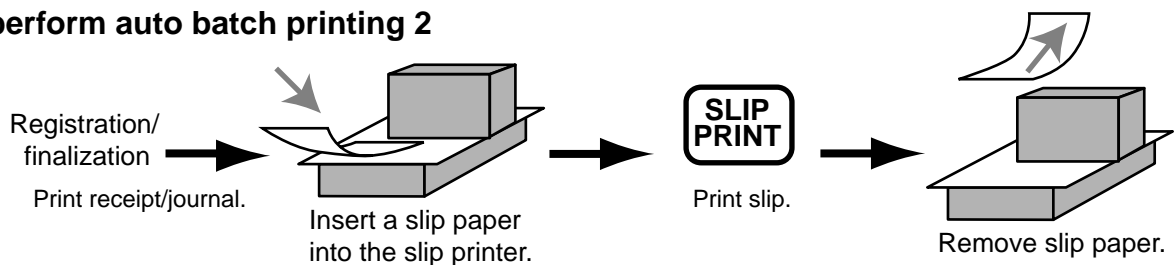

## About the maximum number of slip lines

You can program the maximum number of lines that can be printed on a slip. Once you do, any attempt to exceed the preset maximum results in an error. When such an error occurs, press <C>, change slip paper and press <SLIP PRINT> to restart printing.

# Check tracking systems

## Check tracking system

With the check tracking system, the amount, check number, number of slip print lines, store number, date/time and registration detail data are stored in two files (check tracking index file and check tracking detail file).

- Check tracking detail file and index file are cleared by the following timing:
  1. The check is cleared after printing finalized data on slip or guest check receipts, or the check is also cleared when the new or old check operation is made.
  2. The check is cleared after printing finalized data on slip or guest check receipt, or check is also cleared when the same finalized check number is assigned in new check operation.You can select one of these options by programming.
- Auto new balance function  
The register can be programmed so that whenever a clerk (by clerk key) signs off while a check is open, a <NEW BALANCE> operation is automatically performed to temporarily finalize the open check.
- You can specify a range of checks that can be opened by each clerk. Once you do, any attempt by a clerk to open a check using a number that is not within his specified range results in an error.
- Either of the following two operations can be used to correct input of a wrong check number.
  - <NEW CHECK>  
Re-input the correct check number, or cancel the original check number, issue a receipt, and then re-input the correct check number.
  - <OLD CHECK>, <NEW/OLD>  
Temporary finalize the original check number, issue a receipt, and then re-input the correct check number.



## Opening a check

### Example

OPERATION			RECEIPT																		
Check#	1234		<table border="1" style="width: 100%; border-collapse: collapse;"> <tr> <td colspan="2">CHECK No. 1234</td> </tr> <tr> <td>TBL#</td> <td>000033</td> </tr> <tr> <td>1 DEPT01</td> <td>.10.00</td> </tr> <tr> <td>1 DEPT01</td> <td>.10.00</td> </tr> <tr> <td>1 DEPT02</td> <td>.20.00</td> </tr> <tr> <td>1 DEPT02</td> <td>.20.00</td> </tr> <tr> <td>1 DEPT03</td> <td>.30.00</td> </tr> <tr> <td>+</td> <td>.0.50</td> </tr> <tr> <td>SRVC TL</td> <td>- 90.50</td> </tr> </table>	CHECK No. 1234		TBL#	000033	1 DEPT01	.10.00	1 DEPT01	.10.00	1 DEPT02	.20.00	1 DEPT02	.20.00	1 DEPT03	.30.00	+	.0.50	SRVC TL	- 90.50
CHECK No. 1234																					
TBL#	000033																				
1 DEPT01	.10.00																				
1 DEPT01	.10.00																				
1 DEPT02	.20.00																				
1 DEPT02	.20.00																				
1 DEPT03	.30.00																				
+	.0.50																				
SRVC TL	- 90.50																				
Table#	33																				
Item 1	Dept 1	\$10.00																			
	Quantity	2																			
Item 2	Dept 2	\$20.00																			
	Quantity	2																			
Item 3	Dept 3	\$30.00																			
	Quantity	1																			

1 2 3 4 NEW CHECK  
3 3 TABLE #  
1 0 00 1  
2 0 00 2  
3 0 00 3  
**Insert slip**  
NB  
**Remove slip**

Press <NEW BALANCE> to temporarily close the transaction. If you want to finalize a check immediately, use <CASH>, <CHARGE>, <CREDIT> or <CHECK>.

## Adding to a check

### Example

OPERATION			RECEIPT														
Check#	1234		<table border="1" style="width: 100%; border-collapse: collapse;"> <tr> <td>TABLE No. 000033</td> <td>CT 1</td> </tr> <tr> <td colspan="2">CHECK No. 1234</td> </tr> <tr> <td>ST</td> <td>.90.50</td> </tr> <tr> <td>1 DEPT01</td> <td>.30.00</td> </tr> <tr> <td>1 DEPT02</td> <td>.10.00</td> </tr> <tr> <td>+</td> <td>.0.50</td> </tr> <tr> <td>SRVC TL</td> <td>- 131.00</td> </tr> </table>	TABLE No. 000033	CT 1	CHECK No. 1234		ST	.90.50	1 DEPT01	.30.00	1 DEPT02	.10.00	+	.0.50	SRVC TL	- 131.00
TABLE No. 000033	CT 1																
CHECK No. 1234																	
ST	.90.50																
1 DEPT01	.30.00																
1 DEPT02	.10.00																
+	.0.50																
SRVC TL	- 131.00																
Table#	33																
Item 1	Dept 1	\$30.00															
	Quantity	1															
Item 2	Dept 2	\$10.00															
	Quantity	1															

1 2 3 4 OLD CHECK  
3 0 00 1  
1 0 00 2  
**Insert slip**  
NB  
**Remove slip**

- The table number is stored in the check tracking index memory so its input is not required in this operation even if table number input is preset as compulsory. Table number input after inputting the check number may be performed, however, without generating an error.
- Once a check is opened under a number in a certain mode (REG1 or REG2), the same mode must be used to make additions to the check.

# Advanced Operations

## Issuing a guest receipt

The following operation can be used to print out the balance of a temporarily finalized check.

### Example

OPERATION	RECEIPT																								
<div style="display: flex; align-items: center; gap: 5px;"> <span style="border: 1px solid black; padding: 2px 5px;">1</span> <span style="border: 1px solid black; padding: 2px 5px;">2</span> <span style="border: 1px solid black; padding: 2px 5px;">3</span> <span style="border: 1px solid black; padding: 2px 5px;">4</span> <span style="border: 1px solid black; padding: 2px 5px;">GUEST RECEIPT</span> </div> <p>Input the number of check you want.</p>	<table border="1"> <tr> <td>TABLE No. 000033</td> <td>CT 1</td> </tr> <tr> <td>CHECK No. 1234</td> <td></td> </tr> <tr> <td>1 DEPT01</td> <td style="text-align: right;">.10.00</td> </tr> <tr> <td>1 DEPT01</td> <td style="text-align: right;">.10.00</td> </tr> <tr> <td>1 DEPT02</td> <td style="text-align: right;">.20.00</td> </tr> <tr> <td>1 DEPT02</td> <td style="text-align: right;">.20.00</td> </tr> <tr> <td>1 DEPT03</td> <td style="text-align: right;">.30.00</td> </tr> <tr> <td>+</td> <td style="text-align: right;">.0.50</td> </tr> <tr> <td>1 DEPT01</td> <td style="text-align: right;">.30.00</td> </tr> <tr> <td>1 DEPT02</td> <td style="text-align: right;">.10.00</td> </tr> <tr> <td>+</td> <td style="text-align: right;">.0.50</td> </tr> <tr> <td>SRVC TL</td> <td style="text-align: right;">- 131.00</td> </tr> </table>	TABLE No. 000033	CT 1	CHECK No. 1234		1 DEPT01	.10.00	1 DEPT01	.10.00	1 DEPT02	.20.00	1 DEPT02	.20.00	1 DEPT03	.30.00	+	.0.50	1 DEPT01	.30.00	1 DEPT02	.10.00	+	.0.50	SRVC TL	- 131.00
TABLE No. 000033	CT 1																								
CHECK No. 1234																									
1 DEPT01	.10.00																								
1 DEPT01	.10.00																								
1 DEPT02	.20.00																								
1 DEPT02	.20.00																								
1 DEPT03	.30.00																								
+	.0.50																								
1 DEPT01	.30.00																								
1 DEPT02	.10.00																								
+	.0.50																								
SRVC TL	- 131.00																								

## Closing a check memory

### Example

OPERATION	RECEIPT												
<div style="display: flex; align-items: center; gap: 5px;"> <span style="border: 1px solid black; padding: 2px 5px;">1</span> <span style="border: 1px solid black; padding: 2px 5px;">2</span> <span style="border: 1px solid black; padding: 2px 5px;">3</span> <span style="border: 1px solid black; padding: 2px 5px;">4</span> <span style="border: 1px solid black; padding: 2px 5px;">OLD CHECK</span> </div> <div style="display: flex; align-items: center; gap: 5px; margin-top: 5px;"> <span style="border: 1px solid black; padding: 2px 5px;">1</span> <span style="border: 1px solid black; padding: 2px 5px;">5</span> <span style="border: 1px solid black; padding: 2px 5px;">0</span> <span style="border: 1px solid black; padding: 2px 5px;">00</span> <span style="border: 1px solid black; padding: 2px 5px;">CA / AMT / TEND</span> </div>	<table border="1"> <tr> <td>TABLE No. 000033</td> <td>CT 1</td> </tr> <tr> <td>CHECK No. 1234</td> <td></td> </tr> <tr> <td>ST</td> <td style="text-align: right;">.131.00</td> </tr> <tr> <td>TL</td> <td style="text-align: right;">- 131.00</td> </tr> <tr> <td>CASH</td> <td style="text-align: right;">.150.00</td> </tr> <tr> <td>C6</td> <td style="text-align: right;">.19.00</td> </tr> </table>	TABLE No. 000033	CT 1	CHECK No. 1234		ST	.131.00	TL	- 131.00	CASH	.150.00	C6	.19.00
TABLE No. 000033	CT 1												
CHECK No. 1234													
ST	.131.00												
TL	- 131.00												
CASH	.150.00												
C6	.19.00												

**SLIP**

REG	03-04-2000	17:05
C01	MC#01	000150
TABLE No.	000033	CT 1
CHECK No.	1234	
1	DEPT01	-10.00
1	DEPT01	-10.00
1	DEPT02	-20.00
1	DEPT02	-20.00
1	DEPT03	-30.00
	+	-0.50
#12	SRVC TL	-90.50
1	DEPT01	-30.00
1	DEPT02	-10.00
	+	-0.50
#16	SRVC TL	-131.00
	TL	-131.00
	CASH	-150.00
	CG	-19.00

**New/old check key operation**

**Example 1**

When a check number is input and <NEW/OLD> is pressed, the key works as a new check key function if there is no matching check number in the check tracking memory.

**OPERATION**

**RECEIPT**

Input a check number and press  
 <NEW/OLD>.

CHECK No. 3456		
1	DEPT01	-10.00
1	DEPT02	-20.00
	+	-0.50
	SRVC TL	-30.50

**Example 2**

When a check number is input and <NEW/OLD> is pressed, the key works as an old check key if there is matching check number in the check tracking memory.

**OPERATION**

**RECEIPT**

CHECK No. 3456		
	ST	-30.50
	TL	-30.50
	CASH	-31.00
	CG	-0.50

# Advanced Operations

## Add check

This operation lets you combine the amounts of more than one check into a single check.

### Example

#### Registration for check number 1234

Original check			OPERATION	RECEIPT																							
<table border="1" style="width: 100%; border-collapse: collapse;"> <tr> <td colspan="2">Check#</td> <td style="text-align: right;">1234</td> </tr> <tr> <td rowspan="2">Item 1</td> <td>Dept 1</td> <td style="text-align: right;">\$10.00</td> </tr> <tr> <td>Quantity</td> <td style="text-align: right;">1</td> </tr> <tr> <td rowspan="2">Item 2</td> <td>Dept 2</td> <td style="text-align: right;">\$20.00</td> </tr> <tr> <td>Quantity</td> <td style="text-align: right;">1</td> </tr> </table>			Check#		1234	Item 1	Dept 1	\$10.00	Quantity	1	Item 2	Dept 2	\$20.00	Quantity	1	<div style="display: flex; justify-content: space-around; margin-bottom: 5px;"> <span>1</span><span>2</span><span>3</span><span>4</span><span>NEW CHECK</span> </div> <div style="display: flex; justify-content: space-around; margin-bottom: 5px;"> <span>3</span><span>3</span><span>TABLE #</span> </div> <div style="display: flex; justify-content: space-around; margin-bottom: 5px;"> <span>1</span><span>0</span><span>00</span><span>1</span> </div> <div style="display: flex; justify-content: space-around; margin-bottom: 5px;"> <span>2</span><span>0</span><span>00</span><span>2</span> </div> <div style="text-align: center; border: 1px solid black; padding: 2px;">NB</div>	<p>CHECK No. 1234</p> <table style="width: 100%; border-collapse: collapse;"> <tr> <td>TBL#</td> <td style="text-align: right;">000033</td> </tr> <tr> <td>1 DEPT01</td> <td style="text-align: right;">·10.00</td> </tr> <tr> <td>1 DEPT02</td> <td style="text-align: right;">·20.00</td> </tr> <tr> <td>+</td> <td style="text-align: right;">·0.50</td> </tr> <tr> <td>SRVC TL</td> <td style="text-align: right;">-30.50</td> </tr> </table>	TBL#	000033	1 DEPT01	·10.00	1 DEPT02	·20.00	+	·0.50	SRVC TL	-30.50
Check#		1234																									
Item 1	Dept 1	\$10.00																									
	Quantity	1																									
Item 2	Dept 2	\$20.00																									
	Quantity	1																									
TBL#	000033																										
1 DEPT01	·10.00																										
1 DEPT02	·20.00																										
+	·0.50																										
SRVC TL	-30.50																										

#### Registration for check number 3456

Added check			OPERATION	RECEIPT														
<table border="1" style="width: 100%; border-collapse: collapse;"> <tr> <td colspan="2">Check#</td> <td style="text-align: right;">3456</td> </tr> <tr> <td rowspan="2">Item</td> <td>Dept 1</td> <td style="text-align: right;">\$30.00</td> </tr> <tr> <td>Quantity</td> <td style="text-align: right;">1</td> </tr> </table>			Check#		3456	Item	Dept 1	\$30.00	Quantity	1	<div style="display: flex; justify-content: space-around; margin-bottom: 5px;"> <span>3</span><span>4</span><span>5</span><span>6</span><span>NEW CHECK</span> </div> <div style="display: flex; justify-content: space-around; margin-bottom: 5px;"> <span>3</span><span>0</span><span>00</span><span>1</span> </div> <div style="text-align: center; border: 1px solid black; padding: 2px;">NB</div>	<p>CHECK No. 3456</p> <table style="width: 100%; border-collapse: collapse;"> <tr> <td>1 DEPT01</td> <td style="text-align: right;">·30.00</td> </tr> <tr> <td>+</td> <td style="text-align: right;">·0.50</td> </tr> <tr> <td>SRVC TL</td> <td style="text-align: right;">-30.50</td> </tr> </table>	1 DEPT01	·30.00	+	·0.50	SRVC TL	-30.50
Check#		3456																
Item	Dept 1	\$30.00																
	Quantity	1																
1 DEPT01	·30.00																	
+	·0.50																	
SRVC TL	-30.50																	

#### Registration for check number 1234

Check No. : 1234		OPERATION	RECEIPT													
<div style="border: 1px solid black; padding: 5px; width: 100px; height: 50px; margin: 10px auto;">           Check No. : 3456         </div>	<div style="display: flex; justify-content: space-around; margin-bottom: 5px;"> <span>1</span><span>2</span><span>3</span><span>4</span><span>OLD CHECK</span> </div> <div style="display: flex; justify-content: space-around; margin-bottom: 5px;"> <span>3</span><span>4</span><span>5</span><span>6</span><span>ADD CHECK</span> </div> <div style="text-align: center; border: 1px solid black; padding: 2px;">NB</div>	<table style="width: 100%; border-collapse: collapse;"> <tr> <td>TABLE No. 000033</td> <td style="text-align: right;">CT 1</td> </tr> <tr> <td>CHECK No. 1234</td> <td></td> </tr> <tr> <td>ST</td> <td style="text-align: right;">·30.50</td> </tr> <tr> <td>ADD CHK</td> <td style="text-align: right;">3456</td> </tr> <tr> <td>ST</td> <td style="text-align: right;">·30.50</td> </tr> <tr> <td>+</td> <td style="text-align: right;">·0.50</td> </tr> <tr> <td>SRVC TL</td> <td style="text-align: right;">-61.50</td> </tr> </table>	TABLE No. 000033	CT 1	CHECK No. 1234		ST	·30.50	ADD CHK	3456	ST	·30.50	+	·0.50	SRVC TL	-61.50
TABLE No. 000033	CT 1															
CHECK No. 1234																
ST	·30.50															
ADD CHK	3456															
ST	·30.50															
+	·0.50															
SRVC TL	-61.50															

## Separate check

This operation makes it possible to split a single check into separate checks.

### Example

Check# 1234		
Item 1	Dept 1	\$10.00
	Quantity	1
Item 2	Dept 2	\$20.00
	Quantity	1
Item 3	Dept 3	\$30.00
	Quantity	1
Item 4	Dept 4	\$40.00
	Quantity	1

→

↗

Check# 3456		
Item 1	Dept 1	\$10.00
	Quantity	1
Item 2	Dept 3	\$30.00
	Quantity	1
Payment	Cash	\$40.00

### OPERATION

### RECEIPT

**3 4 5 6**

This input of a temporary check number can be skipped.

**1 2 3 4**

Input the original check number by <SEP CHK>.

Display shows the 1st item which will be separated.

After <SEP CHK>, this item is separated.

Display shows the 3rd item which will be separated.

**4 0 00**

CHECK No. 3456	
SEP CHK	1234
1 DEPT01	- 10.00
1 DEPT03	- 30.00
TL	- 40.00
CASH	- 40.00
CG	- 0.00

# Advanced Operations

## Clerk transfer

This operation lets you change the clerk who is in charge of a specific open check number.

### Example

To change the clerk for check number 1234 from clerk 1 to clerk number 4.

OPERATION	RECEIPT															
<p>Press this key if you do not want the clerk No. or clerk secret No. to appear on the display.</p> <p style="text-align: center;"><b>1</b> <span style="border: 1px solid black; padding: 2px;">CLK TRANS</span></p> <p>Input the clerk No. of the clerk who is currently in charge of check No. 1234 (target check).</p> <p style="text-align: center;"><b>4</b> <span style="border: 1px solid black; padding: 2px;">OP#</span></p> <p>Input the clerk No. of the clerk who will take over check No. 1234 (target check).</p> <p style="text-align: center;"><b>1 2 3 4</b> <span style="border: 1px solid black; padding: 2px;">NEW CHECK</span></p> <p>Input the target check No. that is transferred from clerk 1 to 4. You can use either &lt;OLD CHK&gt;, &lt;NEW/OLD&gt;. Note that if you skip this step, all check Nos currently assigned to clerk 1 are transferred to clerk 4.</p> <p style="text-align: center;"><span style="border: 1px solid black; padding: 2px;">CLK TRANS</span></p>	<table border="1" style="width: 100%; border-collapse: collapse;"> <tr> <td style="width: 60%;">CLK TRANS</td> <td style="width: 20%;"></td> <td style="width: 20%;"></td> </tr> <tr> <td>C01</td> <td style="text-align: right;">C04</td> <td></td> </tr> <tr> <td>1234</td> <td style="text-align: right;">·60.50</td> <td>Check No./NB amount</td> </tr> <tr> <td colspan="3" style="border-top: 1px dashed black;"></td> </tr> <tr> <td>TL</td> <td style="text-align: right;">·60.50</td> <td></td> </tr> </table>	CLK TRANS			C01	C04		1234	·60.50	Check No./NB amount				TL	·60.50	
CLK TRANS																
C01	C04															
1234	·60.50	Check No./NB amount														
TL	·60.50															

## Table transfer

With this operation, you can change the number of a check.

### Example 1

To change the check number 1234 to 1111 (which is newly opened).

Check No:  
1234

1111 <CHK TRN>

Check No:  
1234

Check No:  
1111

OPERATION	RECEIPT															
<p style="text-align: center;"><b>1 2 3 4</b> <span style="border: 1px solid black; padding: 2px;">NEW CHECK</span></p> <p style="text-align: center;"><b>1 0 0 0</b> <span style="border: 1px solid black; padding: 2px;">1</span></p> <p style="text-align: center;"><b>1 1 1 1</b> <span style="border: 1px solid black; padding: 2px;">CHECK TRANS</span></p> <p>Input the new check No.</p>	<table border="1" style="width: 100%; border-collapse: collapse;"> <tr> <td style="width: 60%;">CHECK No. 1234</td> <td style="width: 20%;"></td> <td style="width: 20%;"></td> </tr> <tr> <td>1 DEPT01</td> <td style="text-align: right;">·10.00</td> <td></td> </tr> <tr> <td>ST</td> <td style="text-align: right;">·10.00</td> <td></td> </tr> <tr> <td>TBL TRANS</td> <td style="text-align: right;">1111</td> <td></td> </tr> <tr> <td>SRVC TL</td> <td style="text-align: right;">- 10.00</td> <td></td> </tr> </table>	CHECK No. 1234			1 DEPT01	·10.00		ST	·10.00		TBL TRANS	1111		SRVC TL	- 10.00	
CHECK No. 1234																
1 DEPT01	·10.00															
ST	·10.00															
TBL TRANS	1111															
SRVC TL	- 10.00															

### Example 2

To change the check number 3456 to 2222 (which has already been opened).

Check No:  
3456

Check No:  
2222

1111 <CHK TRN>

Check No:  
3456

Check No:  
2222

Added

OPERATION	RECEIPT															
<p style="text-align: center;"><b>3 4 5 6</b> <span style="border: 1px solid black; padding: 2px;">OLD CHECK</span></p> <p style="text-align: center;"><b>1 0 0 0</b> <span style="border: 1px solid black; padding: 2px;">1</span></p> <p style="text-align: center;"><b>2 2 2 2</b> <span style="border: 1px solid black; padding: 2px;">CHECK TRANS</span></p>	<table border="1" style="width: 100%; border-collapse: collapse;"> <tr> <td style="width: 60%;">CHECK No. 3456</td> <td style="width: 20%;"></td> <td style="width: 20%;"></td> </tr> <tr> <td>ST</td> <td style="text-align: right;">·10.00</td> <td></td> </tr> <tr> <td>1 DEPT01</td> <td style="text-align: right;">·10.00</td> <td></td> </tr> <tr> <td>TBL TRANS</td> <td style="text-align: right;">2222</td> <td></td> </tr> <tr> <td>SRVC TL</td> <td style="text-align: right;">- 30.00</td> <td></td> </tr> </table>	CHECK No. 3456			ST	·10.00		1 DEPT01	·10.00		TBL TRANS	2222		SRVC TL	- 30.00	
CHECK No. 3456																
ST	·10.00															
1 DEPT01	·10.00															
TBL TRANS	2222															
SRVC TL	- 30.00															

# Price reductions (red price)

You can use the reduced price function to change a price; generally to an amount that is less than the normal price. You can program the register so that it prints the normal price, and the difference between the two prices on the receipt, while on journal, these items are always printed.

The following functions are able to work with red price.

- Department and PLU
- Quantity extension (Preset price is required for both department and PLU.)
- Amount limitation of item program (It effects to new price.)

Note that you cannot use red price with the following types of item.

- Department and PLUs programmed with negative unit prices
- Set menus and link PLUs
- Second unit prices
- Multiplication operations that use the format: Amount × Quantity

## Example 1

OPERATION			RECEIPT																	
Item	Dept 1	\$6.00	4 00	RED PRICE																
	Red price	\$4.00	Input a reduced price.																	
Payment	Cash	\$4.00	6 00	1																
			CA/AMT / TEND																	
					<table style="width: 100%; border-collapse: collapse;"> <tr> <td style="width: 80%;">RED</td> <td style="width: 10%; text-align: right;">-6.00</td> <td style="width: 10%;"></td> </tr> <tr> <td>RED PRC</td> <td style="text-align: right;">-2.00</td> <td></td> </tr> <tr> <td>1 DEPT01</td> <td style="text-align: right;">*4.00</td> <td></td> </tr> <tr> <td>TL</td> <td style="text-align: right;">- 4.00</td> <td></td> </tr> <tr> <td>CASH</td> <td style="text-align: right;">-4.00</td> <td></td> </tr> </table>	RED	-6.00		RED PRC	-2.00		1 DEPT01	*4.00		TL	- 4.00		CASH	-4.00	
RED	-6.00																			
RED PRC	-2.00																			
1 DEPT01	*4.00																			
TL	- 4.00																			
CASH	-4.00																			

Old price  
Reduced price  
New price (Difference between two prices)

## Example 2

OPERATION			RECEIPT																	
Item	PLU 1	\$4.00	3	X/DATE TIME																
	Red price	\$2.00	2 00	RED PRICE																
Payment	Cash	\$6.00	Input a reduced price.																	
			1	PLU																
			CA/AMT / TEND																	
					<table style="width: 100%; border-collapse: collapse;"> <tr> <td style="width: 80%;">RED</td> <td style="width: 10%; text-align: right;">-12.00</td> <td style="width: 10%;"></td> </tr> <tr> <td>RED PRC</td> <td style="text-align: right;">-6.00</td> <td></td> </tr> <tr> <td>3 PLU0001</td> <td style="text-align: right;">*6.00</td> <td></td> </tr> <tr> <td>TL</td> <td style="text-align: right;">- 6.00</td> <td></td> </tr> <tr> <td>CASH</td> <td style="text-align: right;">-6.00</td> <td></td> </tr> </table>	RED	-12.00		RED PRC	-6.00		3 PLU0001	*6.00		TL	- 6.00		CASH	-6.00	
RED	-12.00																			
RED PRC	-6.00																			
3 PLU0001	*6.00																			
TL	- 6.00																			
CASH	-6.00																			

- The model for the U.S./Canada, use  FOR DATE TIME instead of  DATE TIME.

## Condiment/preparation PLUs

You can force entering condiment or preparation PLU after the main PLU registration by programming.

### Example (condiment PLU)

			OPERATION	RECEIPT												
Main item	PLU 1	\$10.00	<b>1</b> <b>PLU</b>	<table border="1"> <tr><td>1 PLU0001</td><td>·10.00</td></tr> <tr><td>PLU0011</td><td>·0.10</td></tr> <tr><td>PLU0012</td><td>·0.20</td></tr> <tr><td>PLU0013</td><td>·0.30</td></tr> <tr><td>TL</td><td>- 10.60</td></tr> <tr><td>CASH</td><td>·10.60</td></tr> </table>	1 PLU0001	·10.00	PLU0011	·0.10	PLU0012	·0.20	PLU0013	·0.30	TL	- 10.60	CASH	·10.60
1 PLU0001	·10.00															
PLU0011	·0.10															
PLU0012	·0.20															
PLU0013	·0.30															
TL	- 10.60															
CASH	·10.60															
	PLU 11	\$0.10	Registering main PLU.													
Condiment	PLU 12	\$0.20	No condiment registration occurs an error condition.													
	PLU 13	\$0.30	<b>1</b> <b>1</b> <b>PLU</b>													
Payment	Cash	\$10.60	<b>1</b> <b>2</b> <b>PLU</b>													
			<b>1</b> <b>3</b> <b>PLU</b>													
			CA/AMT /TEND													

### Example (preparation PLU)

			OPERATION	RECEIPT												
Main item	PLU 20	\$20.00	<b>2</b> <b>0</b> <b>PLU</b>	<table border="1"> <tr><td>1 PLU0020</td><td>·20.00</td></tr> <tr><td>PLU0021</td><td></td></tr> <tr><td>PLU0022</td><td></td></tr> <tr><td>PLU0023</td><td></td></tr> <tr><td>TL</td><td>- 20.00</td></tr> <tr><td>CASH</td><td>·20.00</td></tr> </table>	1 PLU0020	·20.00	PLU0021		PLU0022		PLU0023		TL	- 20.00	CASH	·20.00
1 PLU0020	·20.00															
PLU0021																
PLU0022																
PLU0023																
TL	- 20.00															
CASH	·20.00															
	PLU 21	\$0.00	Registering main PLU.													
Preparation	PLU 22	\$0.00	<b>2</b> <b>1</b> <b>PLU</b>													
	PLU 23	\$0.00	<b>2</b> <b>2</b> <b>PLU</b>													
Payment	Cash	\$20.00	<b>2</b> <b>3</b> <b>PLU</b>													
			CA/AMT /TEND													



# VAT breakdown printing

You can force printing of the VAT breakdown at the finalize stage, regardless of whether the cash register is programmed to print or skip printing of the VAT breakdown. Every time you want to have VAT breakdown, press <VAT>.

## Example

OPERATION			RECEIPT			
Item 1	Dept 1	\$1.00	1 00 1	1 DEPT01	T1	-1.00
	Taxable	1		1 PLU0001	T2	-2.00
Item 2	PLU 1	(\$2.00)	1 PLU	TA1		-0.90
	Taxable	2		TX1		-0.10
Payment	Cash	\$3.00	VAT	TA2		-1.90
				TX2		-0.10
			CA/AMT TEND	TL		-3.00
				CASH		-3.00

# Deposit registrations

Use the following procedures to register deposits.

## Deposit from customer

OPERATION			RECEIPT			
Deposit	Cash	\$50.00	5 0 00 DEPOSIT -	DEPO-		-50.00
				CA/AMT TEND	TL	
				CASH		-50.00

## Deposit from customer during sales transaction

OPERATION			RECEIPT			
Items	Dept 1	\$10.00	1 0 00 1	1 DEPT01		-10.00
	Dept 2	\$20.00		1 DEPT02		-20.00
Deposit		\$20.00	2 0 00 2	DEPO+		-20.00
				2 0 00 DEPOSIT +	TL	
Payment	Cash	\$10.00	CA/AMT TEND	CASH		-10.00

# Advanced Operations

## Bill copy

### Example 1

To issue a copy of a bill dated February 1, 2004 in the amount of \$35.00 cash.

OPERATION	RECEIPT
<div style="display: flex; justify-content: space-around; align-items: center;"> <div style="display: flex; gap: 5px;"> <span style="border: 1px solid black; padding: 2px 5px;">0</span> <span style="border: 1px solid black; padding: 2px 5px;">2</span> <span style="border: 1px solid black; padding: 2px 5px;">0</span> <span style="border: 1px solid black; padding: 2px 5px;">1</span> <span style="border: 1px solid black; padding: 2px 5px;">2</span> <span style="border: 1px solid black; padding: 2px 5px;">0</span> <span style="border: 1px solid black; padding: 2px 5px;">0</span> <span style="border: 1px solid black; padding: 2px 5px;">4</span> </div> <div style="border: 1px solid black; padding: 2px; font-size: 8px;">BILL COPY</div> </div> <p style="text-align: center; font-size: 10px;">Enter date by date order.</p> <div style="display: flex; justify-content: space-around; align-items: center; margin-top: 10px;"> <div style="display: flex; gap: 5px;"> <span style="border: 1px solid black; padding: 2px 5px;">3</span> <span style="border: 1px solid black; padding: 2px 5px;">5</span> <span style="border: 1px solid black; padding: 2px 5px;">00</span> </div> <div style="border: 1px solid black; padding: 2px; font-size: 8px;">CA / AMT / TEND</div> </div>	<pre style="font-family: monospace; font-size: 10px;"> * BILL TOP MESSAGE 1 * * BILL TOP MESSAGE 2 * * BILL TOP MESSAGE 3 * * BILL TOP MESSAGE 4 *  REG 02-01-2004(SUN) C01          MC#01 * BILL COPY MESSAGE 1 * * BILL COPY MESSAGE 2 * * BILL COPY MESSAGE 3 * * BILL COPY MESSAGE 4 *   TA1                .35.00   TX1                .3.50   TL                 -38.50   CASH               .38.50  * BILL BTM MESSAGE 1 * * BILL BTM MESSAGE 2 * * BILL BTM MESSAGE 3 * * BILL BTM MESSAGE 4 *                     </pre> <div style="font-size: 10px; margin-top: 5px;"> <p>Bill top message *<sup>1</sup></p> <p>Bill copy message *<sup>1</sup></p> <p>Add-on tax amount</p> <p>Bill bottom message *<sup>1</sup></p> <p>*<sup>1</sup> Programmable option</p> </div>

Note that you can finalize this operation using the cash amount tendered key.

### Example 2

To issue a copy of a bill dated February 1, 2004 in the amount of Euro 30.00 cash (sub-currency).

OPERATION	RECEIPT
<div style="display: flex; justify-content: space-around; align-items: center;"> <div style="display: flex; gap: 5px;"> <span style="border: 1px solid black; padding: 2px 5px;">0</span> <span style="border: 1px solid black; padding: 2px 5px;">2</span> <span style="border: 1px solid black; padding: 2px 5px;">0</span> <span style="border: 1px solid black; padding: 2px 5px;">1</span> <span style="border: 1px solid black; padding: 2px 5px;">2</span> <span style="border: 1px solid black; padding: 2px 5px;">0</span> <span style="border: 1px solid black; padding: 2px 5px;">0</span> <span style="border: 1px solid black; padding: 2px 5px;">4</span> </div> <div style="border: 1px solid black; padding: 2px; font-size: 8px;">BILL COPY</div> </div> <div style="text-align: center; margin: 5px 0;"> <div style="border: 1px solid black; padding: 2px; font-size: 8px;">PD</div> </div> <div style="display: flex; justify-content: space-around; align-items: center; margin-top: 10px;"> <div style="display: flex; gap: 5px;"> <span style="border: 1px solid black; padding: 2px 5px;">3</span> <span style="border: 1px solid black; padding: 2px 5px;">0</span> <span style="border: 1px solid black; padding: 2px 5px;">00</span> </div> <div style="border: 1px solid black; padding: 2px; font-size: 8px;">CA / AMT / TEND</div> </div>	<pre style="font-family: monospace; font-size: 10px;"> * BILL TOP MESSAGE 1 * * BILL TOP MESSAGE 2 * * BILL TOP MESSAGE 3 * * BILL TOP MESSAGE 4 *  REG 02-01-2004(SUN) C01          MC#01 * BILL COPY MESSAGE 1 * * BILL COPY MESSAGE 2 * * BILL COPY MESSAGE 3 * * BILL COPY MESSAGE 4 *   TA1                27.28   TX1                2.72   TL                 30.00   CASH               30.00  * BILL BTM MESSAGE 1 * * BILL BTM MESSAGE 2 * * BILL BTM MESSAGE 3 * * BILL BTM MESSAGE 4 *                     </pre> <div style="font-size: 10px; margin-top: 5px;"> <p>Bill top message *<sup>1</sup></p> <p>Bill copy message *<sup>1</sup></p> <p>Add-in tax amount</p> <p>Bill bottom message *<sup>1</sup></p> <p>*<sup>1</sup> Programmable option</p> </div>

## Actual stock quantity inquiry

With this operation, you can recall the actual stock quantity for PLUs and show it on the display of the cash register.

### Example

To check the actual stock quantity of PLU 32 and flat-PLU 001.

OPERATION	DISPLAY (7segment)
<div style="display: flex; flex-direction: column; align-items: center;"> <div style="display: flex; gap: 10px;"> <div style="border: 1px solid black; padding: 2px 5px;">3</div> <div style="border: 1px solid black; padding: 2px 5px;">2</div> <div style="border: 1px solid black; padding: 2px 5px;">PLU</div> </div> <div style="margin-top: 5px;">STOCK INQ</div> </div>	<div style="border: 1px solid black; padding: 5px; width: 150px; margin: 0 auto;">12345</div>
<div style="display: flex; flex-direction: column; align-items: center;"> <div style="border: 1px solid black; padding: 2px 5px;">STOCK INQ</div> <div style="border: 1px solid black; padding: 2px 5px;">001</div> </div>	<div style="border: 1px solid black; padding: 5px; width: 150px; margin: 0 auto;">1</div>

Actual stock quantity are appeared.

## Unit price inquiry

Use this operation to recall the unit prices of departments, PLUs, second unit price of PLUs, or scanning PLUs. The unit prices appear on the display of the cash register when recalled.

### Example

To check the unit price of PLU 32, flat-PLU 001, department 1.

OPERATION	DISPLAY (7 segment)
<div style="display: flex; flex-direction: column; align-items: center;"> <div style="display: flex; gap: 10px;"> <div style="border: 1px solid black; padding: 2px 5px;">3</div> <div style="border: 1px solid black; padding: 2px 5px;">2</div> <div style="border: 1px solid black; padding: 2px 5px;">PLU</div> </div> <div style="margin-top: 5px;">PRICE INQ</div> </div>	<div style="border: 1px solid black; padding: 5px; width: 150px; margin: 0 auto;">145</div>
<div style="display: flex; flex-direction: column; align-items: center;"> <div style="border: 1px solid black; padding: 2px 5px;">PRICE INQ</div> <div style="border: 1px solid black; padding: 2px 5px;">001</div> </div>	<div style="border: 1px solid black; padding: 5px; width: 150px; margin: 0 auto;">3.00</div>
<div style="display: flex; flex-direction: column; align-items: center;"> <div style="border: 1px solid black; padding: 2px 5px;">PRICE INQ</div> <div style="border: 1px solid black; padding: 2px 5px;">1</div> </div>	<div style="border: 1px solid black; padding: 5px; width: 150px; margin: 0 auto;">14.00</div>

## Previous item void using <REVIEW>

You can correct the previously registered item(s) in the same transaction by using <REVIEW> (review key).

### Example

			OPERATION	DISPLAY
Item 1	Dept. 1	\$2.35	<div style="display: flex; justify-content: space-around; margin-bottom: 5px;"> <span style="border: 1px solid black; padding: 2px;">2</span> <span style="border: 1px solid black; padding: 2px;">3</span> <span style="border: 1px solid black; padding: 2px;">5</span> <span style="border: 1px solid black; padding: 2px;">1</span> </div>	1 ST     ·2.35 DEPT01 <div style="text-align: right; font-size: 1.2em;">2.35</div>
	Quantity	1		2 ST     ·4.35 DEPT02 <div style="text-align: right; font-size: 1.2em;">2.00</div>
Item 2	Dept. 2	\$2.00	<div style="display: flex; justify-content: space-around; margin-bottom: 5px;"> <span style="border: 1px solid black; padding: 2px;">2</span> <span style="border: 1px solid black; padding: 2px;">00</span> <span style="border: 1px solid black; padding: 2px;">2</span> </div>	3 ST     ·5.55 PLU001 <div style="text-align: right; font-size: 1.2em;">1.20</div>
	Quantity	1		** REVIEW ** DEPT01     1 QT <div style="text-align: right; font-size: 1.2em;">2.35</div>
Item 3	PLU 1	(\$1.20) <sub>preset</sub>	<div style="display: flex; justify-content: space-around; margin-bottom: 5px;"> <span style="border: 1px solid black; padding: 2px;">1</span> <span style="border: 1px solid black; padding: 2px;">PLU</span> </div>	2 ST     ·3.20 DEPT01 <div style="text-align: right; font-size: 1.2em;">-2.35</div>
	Quantity	1		CASH <div style="text-align: right; font-size: 1.2em;">3.20</div>
Corrected Item 1	Dept. 1	\$2.35	<div style="border: 1px solid black; padding: 2px; width: fit-content; margin: 0 auto;">REVIEW</div>	
	Quantity	1	<div style="border: 1px solid black; padding: 2px; width: fit-content; margin: 0 auto;">VOID</div>	
Payment	Cash	\$3.20	<div style="border: 1px solid black; padding: 2px; width: fit-content; margin: 0 auto;">CA/AMT /TEND</div>	

Review the item to be corrected.

Press <VOID> to correct.

### RECEIPT

1 DEPT01	·2.35	*1
1 DEPT02	·2.00	
1 PLU0001	·1.20	
VOID	.....	*1
1 DEPT01	-2.35	*1
TL	- 3.20	
CASH	·3.20	

\*1 These items can be skipped by program.

# Scanning PLU

Product barcodes are read by scanning with hand-held scanner, and are filed in the scanning PLU file together with the unit price, item descriptor, programming status, link department, totalizer and counter.

When a barcode is entered by scanning, or from the keyboard by using <OBR> (OBR key) or <One touch NLU> (One touch NLU key) and it has been filed in the scanning PLU file, the preset unit price is accumulated to its own totalizer and other appropriate totalizers.

Scanning PLUs include UPC-A/UPC-E/EAN-13/EAN-8, source marking, in-store marking code.

## Item registration

### By scanner/code input/one touch NLU key

OPERATION			RECEIPT			
Item 1 (scan)	Scan-PLU	(\$2.35)	<p><b>“Scanning”</b></p> <div style="display: flex; justify-content: center; gap: 10px;"> <div style="display: flex; gap: 5px;"> <div style="border: 1px solid black; padding: 2px 5px;">1</div> <div style="border: 1px solid black; padding: 2px 5px;">2</div> <div style="border: 1px solid black; padding: 2px 5px;">3</div> </div> <div style="display: flex; gap: 5px;"> <div style="border: 1px solid black; padding: 2px 5px;">4</div> <div style="border: 1px solid black; padding: 2px 5px;">5</div> <div style="border: 1px solid black; padding: 2px 5px;">6</div> <div style="border: 1px solid black; padding: 2px 5px;">OBR</div> </div> </div> <p>Scanning-PLU code and OBR key</p> <div style="text-align: center; margin: 10px 0;"> <div style="border: 1px solid black; padding: 2px 5px;">NLU</div> <p>One touch NLU</p> </div> <div style="text-align: center; margin-top: 10px;"> <div style="border: 1px solid black; padding: 2px 5px;">CA/AMT/TEND</div> </div>	1 Scan-PLU01 #49012347	· 2.34	Scanning PLU code *1
	PLU code	49012347		1 Scan-PLU02 #123456	· 2.00	
Item 2 (code)	Scan-PLU	(\$2.00)		1 Scan-PLU03 #49012354	· 1.23	
Item 3 (OTN)	PLU code	123456		TL	- 5.58	*1 Programmable option
	Scan-PLU	(\$1.23)		CASH	· 5.58	
Payment	Cash	\$5.58				

### Not found PLU

When a scanning PLU item which does not exist in the scanning PLU file is registered, an error occurs (Item not found error). In this case, you can input this item to the ECR and register it at the same time. After this operation, “Item not found error” does not occur during the next registration.

OPERATION			RECEIPT			
Item 1 (scan)	Scan-PLU	(\$1.00)	<p><b>“Scanning”</b></p> <p>Does not exist in the scanning PLU file</p> <p><b>“Not Found Error”</b></p> <div style="display: flex; justify-content: center; gap: 10px;"> <div style="border: 1px solid black; padding: 2px 5px;">1</div> <div style="border: 1px solid black; padding: 2px 5px;">0</div> <div style="border: 1px solid black; padding: 2px 5px;">0</div> <div style="border: 1px solid black; padding: 2px 5px;">1</div> </div> <p>Input price and press the linked department key.</p> <p><b>“Scanning”</b></p> <p>Register normally.</p> <div style="text-align: center; margin-top: 10px;"> <div style="border: 1px solid black; padding: 2px 5px;">CA/AMT/TEND</div> </div>	2 DEPT01 #49012361	· 2.00	Link department descriptor/amount
	PLU code	49012361		TL	- 2.00	
Item 2 (scan)	Dept.	1		CASH	· 2.00	
	Scan-PLU	(\$1.00)				
Payment	Cash	\$2.00				

After daily operation, a “Not found PLU maintenance” is necessary to merge not found PLU(s) into the scanning PLU file. Please consult with your dealer in detail.

## Programming to clerk

You can program up to 4-digit assigning number (clerk number), trainee status of clerk (i.e. training cashier) and commission rate for each clerk.

### Programming clerk number

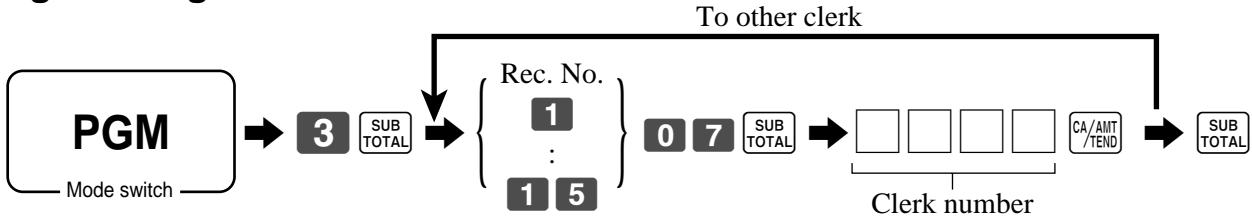

### Programming trainee status

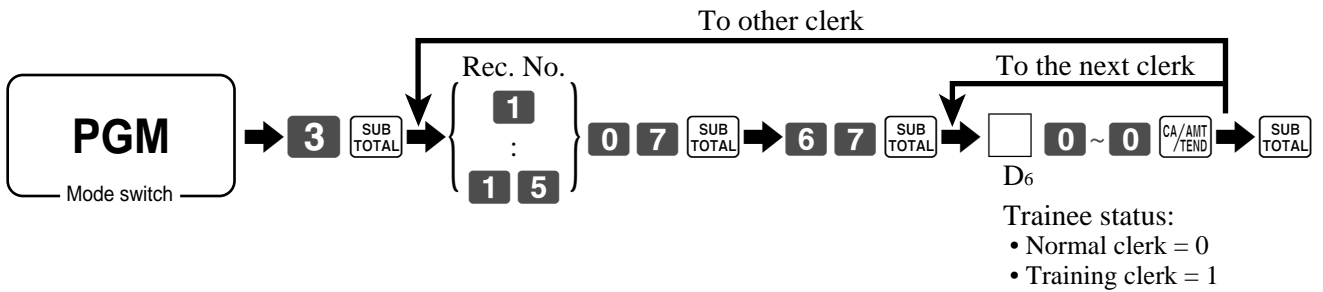

### Programming commission rate

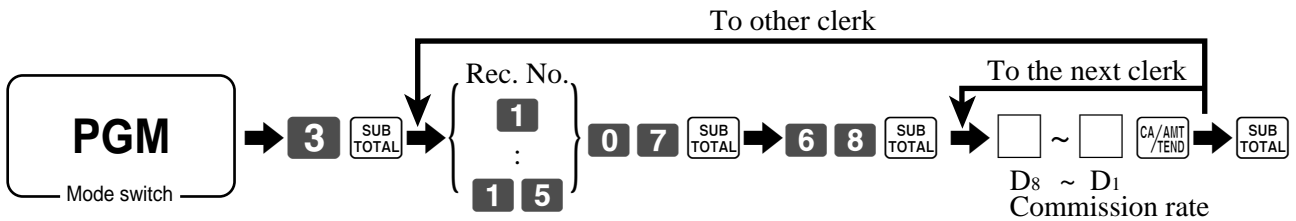

Record No.	Clerk number				Trainee status	Commission rate							
						Commission rate 1				Commission rate 2			
	D <sub>4</sub>	D <sub>3</sub>	D <sub>2</sub>	D <sub>1</sub>		D <sub>6</sub>	Integer		Decimal		Integer		Decimal
						D <sub>8</sub>	D <sub>7</sub>	D <sub>6</sub>	D <sub>5</sub>	D <sub>4</sub>	D <sub>3</sub>	D <sub>2</sub>	D <sub>1</sub>
1													
2													
3													
4													
5													
6													
7													
8													
9													
10													
11													
12													
13													
14													
15													

Character programming can be performed in two ways:

- Character keyboard programming (see page 99),  
or
- Entering characters by code (see page 100).

## Programming descriptors and messages

The following descriptors and messages can be programmed;

- Messages (Logo, commercial and bottom message)
- Clerk name
- PLU item descriptor
- Department key descriptor
- Machine number

### Programming receipt message, machine No. and clerk name

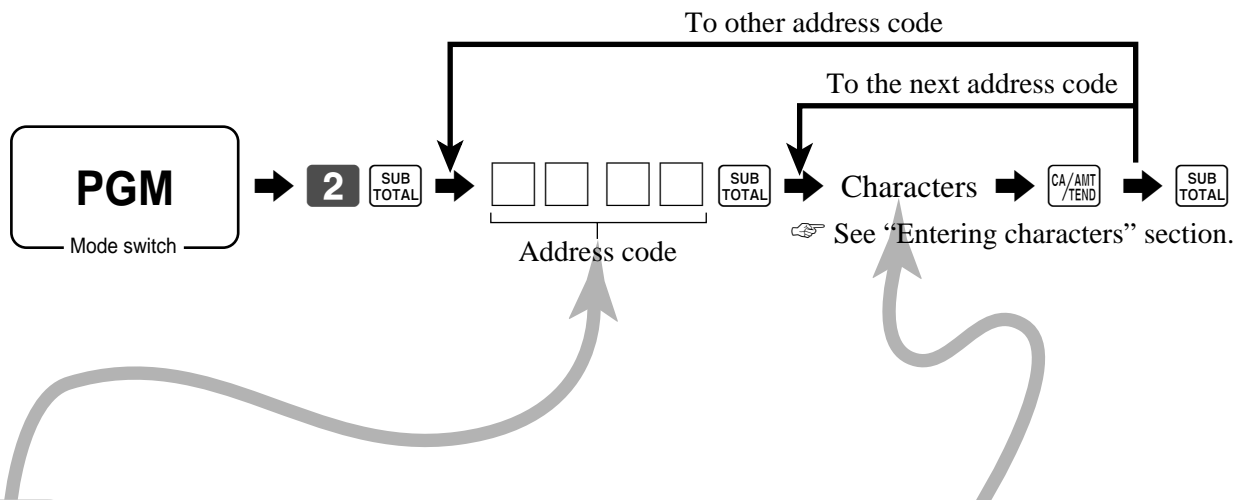

Address code	Contents	Initial character	Yours																				
0107	Clerk 01	C01																					
0207	Clerk 02	C02																					
0307	Clerk 03	C03																					
0407	Clerk 04	C04																					
0507	Clerk 05	C05																					
0607	Clerk 06	C06																					
0707	Clerk 07	C07																					
0807	Clerk 08	C08																					
0907	Clerk 09	C09																					
1007	Clerk 10	C10																					
1107	Clerk 11	C11																					
1207	Clerk 12	C12																					
1307	Clerk 13	C13																					
1407	Clerk 14	C14																					
1507	Clerk 15	C15																					
0191	Machine number	MC#01																					

# Advanced Operations

Address code	Contents	Initial character	Yours
0132	1st line of logo message	YOUR RECEIPT	
0232	2nd line of logo message	THANK YOU	
0332	3rd line of logo message	CALL AGAIN	
0432	4th line of logo message		
0532	1st line of commercial message		
0632	2nd line of commercial message		
0732	3rd line of commercial message		
0832	4th line of commercial message		
0932	1st line of bottom message		
1032	2nd line of bottom message		
1132	3rd line of bottom message		
1232	4th line of bottom message		
1332	1st line of bill top message		
1432	2nd line of bill top message		
1532	3rd line of bill top message		
1632	4th line of bill top message		
1732	1st line of bill copy message		
1832	2nd line of bill copy message		
1932	3rd line of bill copy message		
2032	4th line of bill copy message		
2132	1st line of bill bottom message		
2232	2nd line of bill bottom message		
2332	3rd line of bill bottom message		
2432	4th line of bill bottom message		
2532	Post receipt message	DUPLICATE RECEIPT	
2632	1st line of guest intermediate msg.		
2732	2nd line of guest intermediate msg.		
2832	3rd line of guest intermediate msg.		
2932	4th line of guest intermediate msg.		
3032	1st line of guest bottom msg.		
3132	2nd line of guest bottom msg.		
3232	3rd line of guest bottom msg.		
3332	4th line of guest bottom msg.		
3432	5th line of guest bottom msg.		
3532	6th line of guest bottom msg.		
3632	7th line of guest bottom msg.		
3732	8th line of guest bottom msg.		
3832	9th line of guest bottom msg.		
3932	10th line of guest bottom msg.		



## Programming department/transaction key descriptor

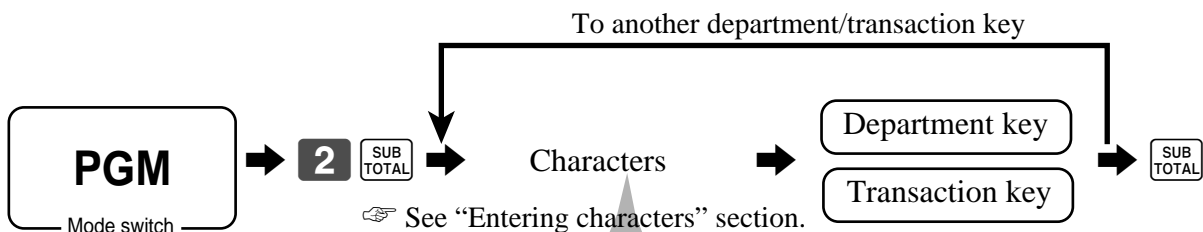

Contents	Initial character	Yours											
Department 01	DEPT01												
Department 02	DEPT02												
Department 03	DEPT03												
Department 04	DEPT04												
Department 05	DEPT05												
Department 06	DEPT06												
Department 07	DEPT07												
Department 08	DEPT08												

Contents	Initial character	Yours											
Cash / Amount tendered	CASH												
Charge	CHARGE												
Check	CHECK												
Credit 1	CREDIT1												
Credit 2	CREDIT2												
Loan	LOAN												
Received on account	RC												
Paid out	PD												
Pick up	P. UP												
Minus	-												
Discount	%-												
Refund	RF												
Correction	CORR												
Currency exchange	CE												
Receipt	RCT												
Non add / No sale	#/NS												
VAT	VAT												
Tax shift 1	T/S1												
Tax shift 2	T/S2												
Open	OPEN												
Clerk number	CLK#												
Subtotal	SUBTOTAL												
Receipt on / off	RCT ON/OFF												
Multiplication / Date time	X												
Multiplication / for / Date time	QT												
Two zero	00												
Decimal point	.												

# Advanced Operations

## Programming flat-PLU descriptor

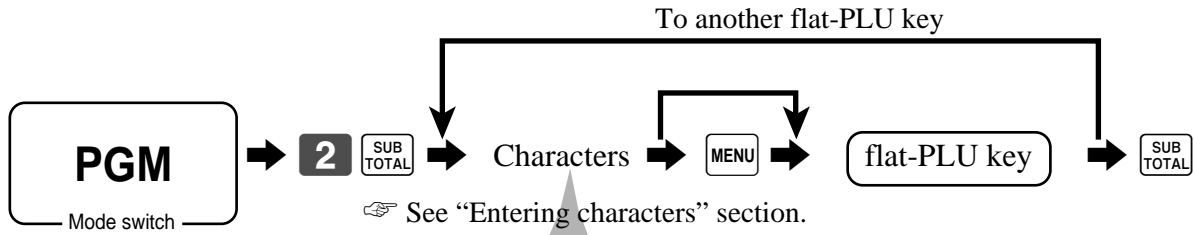

See “Entering characters” section.

Use **MENU** to program to 2nd ~ 6th flat-PLU key.

PLU No.	Contents	Initial character	Yours																					
001	PLU 001	PLU0001																						
002	PLU 002	PLU0002																						
003	PLU 003	PLU0003																						
004	PLU 004	PLU0004																						
005	PLU 005	PLU0005																						
006	PLU 006	PLU0006																						
007	PLU 007	PLU0007																						
008	PLU 008	PLU0008																						
009	PLU 009	PLU0009																						
010	PLU 010	PLU0010																						
011	PLU 011	PLU0011																						
012	PLU 012	PLU0012																						
013	PLU 013	PLU0013																						
014	PLU 014	PLU0014																						
015	PLU 015	PLU0015																						
016	PLU 016	PLU0016																						
017	PLU 017	PLU0017																						
018	PLU 018	PLU0018																						
019	PLU 019	PLU0019																						
020	PLU 020	PLU0020																						
021	PLU 021	PLU0021																						
022	PLU 022	PLU0022																						
023	PLU 023	PLU0023																						
024	PLU 024	PLU0024																						
025	PLU 025	PLU0025																						
026	PLU 026	PLU0026																						
027	PLU 027	PLU0027																						
028	PLU 028	PLU0028																						
029	PLU 029	PLU0029																						
030	PLU 030	PLU0030																						
031	PLU 031	PLU0031																						
032	PLU 032	PLU0032																						
033	PLU 033	PLU0033																						
034	PLU 034	PLU0034																						
035	PLU 035	PLU0035																						

# Entering characters

In this section, the method to enter descriptors or messages (characters) to the cash register during programming is described.

Characters are specified by character keyboard or by codes. In the first half of this section, the usage of character keyboard is described. In the latter half, inputting method by character code is described.

## Using character keyboard

### Example:

Input “ **A** p p l e J u i c e ”,  
 enter “DBL” “A” “SHIFT” “p” “p” “l” “e” “SPACE” “CAP” “J” “SHIFT” “u” “i” “c” “e” **00** .

#### ① Shift key

Press this key to shift the following characters from the uppercase letter to lowercase letter and returns to the uppercase letter in sequence.

#### ② Left cursor key

Press this key to shift the character setting position to the left one by one. This key is used to correct already entered characters.

#### ③ Right cursor key

Press this key to shift the character setting position to the right one by one. This key is used to correct already entered characters.

#### ④ Double size letter key

Press this key to specify that the next character you input to a double size character.

#### ⑤ Space key

Press this key to set a space.

#### ⑥ CAP key

Press this key to shift the character to the uppercase letter.

#### ⑦ Alphabet keys

Press these keys to input characters.

#### ⑧ Numeric keys

Press these keys to enter program codes, memory number and character codes.

#### ⑨ Character fixed key

Press this key to enter when the alphabetic entry for a descriptor, name or message has been completed.

#### ⑩ Backspace/Character code fixed key

Press this key to register one character with code (2 or 3 digit).

TE-4000F

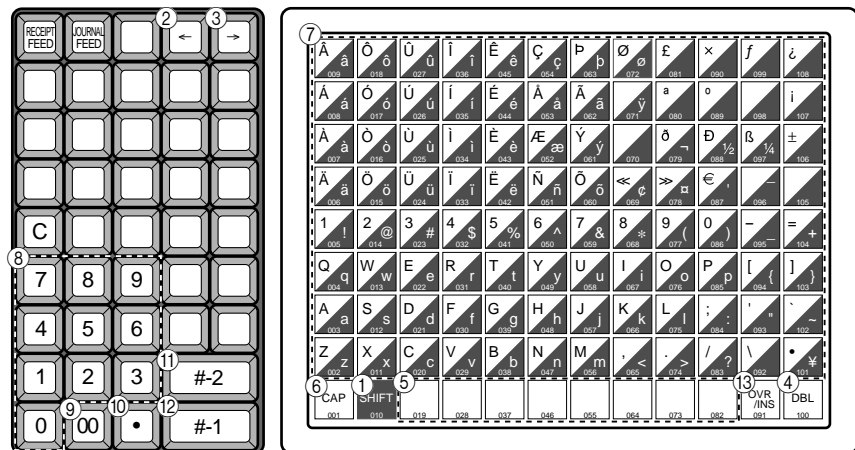

TE-4500F

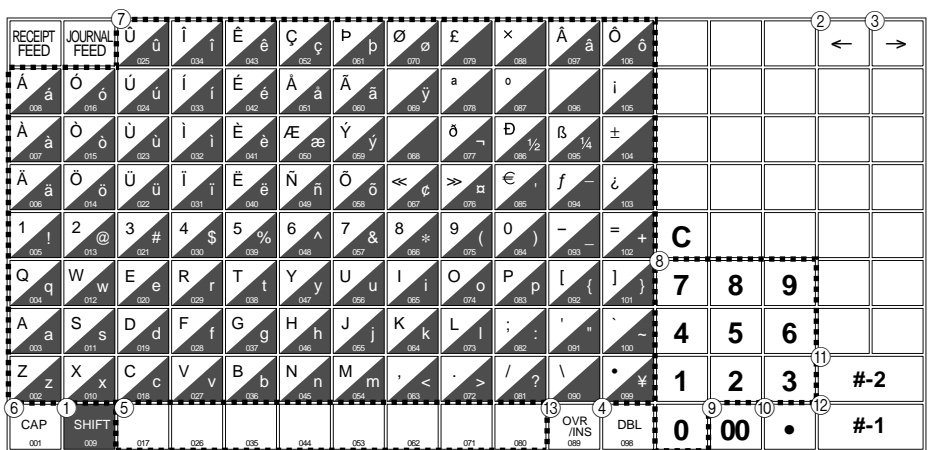

It clears the last input character, much like a back space key. (Does not clear the double size letter key entry.)

#### ⑪ Program end key

Press this key to terminate the character programming.

#### ⑫ Character enter key

Press this key to register the programmed characters.

#### ⑬ Insert/Override key

Press this key to change the status “Insert” between the original characters or “Override” the original characters.

# Advanced Operations

## Entering characters by code

Every time you enter a character, choose character codes by the character code list (below) and press the  key to settle it. After you complete entering characters, press the **00** key to fix them.

**Example:**







Input “ **A** p p l e J u i c e ”,  
 enter “ 255  65  112  112  108  101  32  74  117  105  99  101  **00** ”

## Character code list

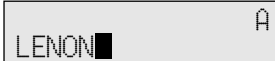
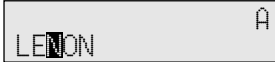
Chara	Code	Chara	Code	Chara	Code	Chara	Code	Chara	Code	Chara	Code	Chara	Code
Space	32	0	48	@	64	P	80	'	96	p	112	Ç	128
!	33	1	49	A	65	Q	81	a	97	q	113	ü	129
"	34	2	50	B	66	R	82	b	98	r	114	é	130
#	35	3	51	C	67	S	83	c	99	s	115	â	131
\$	36	4	52	D	68	T	84	d	100	t	116	ä	132
%	37	5	53	E	69	U	85	e	101	u	117	à	133
&	38	6	54	F	70	V	86	f	102	v	118	å	134
'	39	7	55	G	71	W	87	g	103	w	119	ç	135
(	40	8	56	H	72	X	88	h	104	x	120	ê	136
)	41	9	57	I	73	Y	89	i	105	y	121	ë	137
*	42	:	58	J	74	Z	90	j	106	z	122	è	138
+	43	;	59	K	75	[	91	k	107	{	123	ï	139
,	44	<	60	L	76	\	92	l	108		124	î	140
-	45	=	61	M	77	]	93	m	109	}	125	ì	141
.	46	>	62	N	78	^	94	n	110	~	126	Ä	142
/	47	?	63	O	79	_	95	o	111		127	Å	143
É	144	á	160	■	176	ℓ	192	ø	208	Ó	224	-	240
æ	145	í	161	■	177	⊥	193	Ð	209	ß	225	±	241
Æ	146	ó	162	■	178	⊥	194	Ê	210	Ô	226	_	242
ô	147	ú	163		179	†	195	Ë	211	Ò	227	3/4	243
ö	148	ñ	164	†	180	—	196	È	212	õ	228	¶	244
ò	149	Ñ	165	Á	181	†	197		213	Õ	229	§	245
û	150	ª	166	Â	182	ã	198	í	214	μ	230	÷	246
ù	151	º	167	À	183	Ã	199	î	215	þ	231	¸	247
ÿ	152	¿	168	©	184	ℓ	200	ï	216	Þ	232	°	248
Ö	153	®	169	†	185	⌈	201	¸	217	Ú	233	ˆ	249
Ü	154	¬	170		186	⊥	202	⌈	218	Û	234	•	250
ø	155	1/2	171	⌈	187	⊥	203	■	219	Ù	235	¹	251
£	156	1/4	172	¸	188	†	204	■	220	Ý	236	³	252
Ø	157	¡	173	¢	189	—	205		221	Ý	237	²	253
×	158	«	174	¥	190	†	206	ì	222	—	238	■	254
f	159	»	175	¦	191	¤	207	■	223	'	239	Double size	255

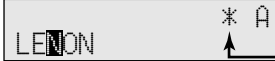

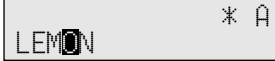





## Editing characters

### Correcting a character just entered







OPERATION	DISPLAY (dot)
“L” “E” “N” “O” “N”	
↩ Enter LENON, instead of LEMON.	
 ↩ Press left arrow key three times.	
 ↩ Override mode	
“M” ↩ Enter “M”.	

\* means “OVR” mode.

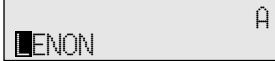

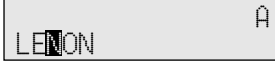

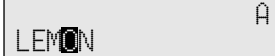
### Correcting and adding a PLU descriptor already set

OPERATION	DISPLAY (dot)
 ↩ Enter “00”.	
 ↩ Enter PLU No.	
“S” “o” “d” “a” “ ” ↩ Enter “Soda” and “space”.	
 ↩ Override mode	
“L” ↩ Enter “L”.	

### Correcting a key descriptor already set

OPERATION	DISPLAY (dot)
 ↩ Enter “00”.	
 ↩ Designate an appropriate key.	
 ↩ Press right arrow key two times.	
“M” ↩ Enter “M”.	
 ↩ Delete “N”.	

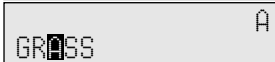
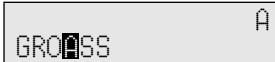
### Correcting a message descriptor already set

OPERATION	DISPLAY (dot)
 ↩ Enter record and file number.	
 ↩ Press right arrow key two times.	
“O” ↩ Enter “O”.	
 ↩ Delete “A”.	

## Printing read/reset reports

### • Daily sales read report (“X1” mode)

You can print read reports at any time during the business day without affecting the data stored in the cash register's memory.

### • Daily sales reset report (“Z1” mode)

You should print reset reports at the end of the business day.

### Important!

- The reset operation issues a report and also clears all sales data from the cash register's memory.
- Be sure to perform the reset operations at the end of each business day. Otherwise, you will not be able to distinguish between the sales data for different dates.

### To print the individual department, PLU/flat-PLU read report

This report shows sales for specific departments or PLUs/flat-PLUs.

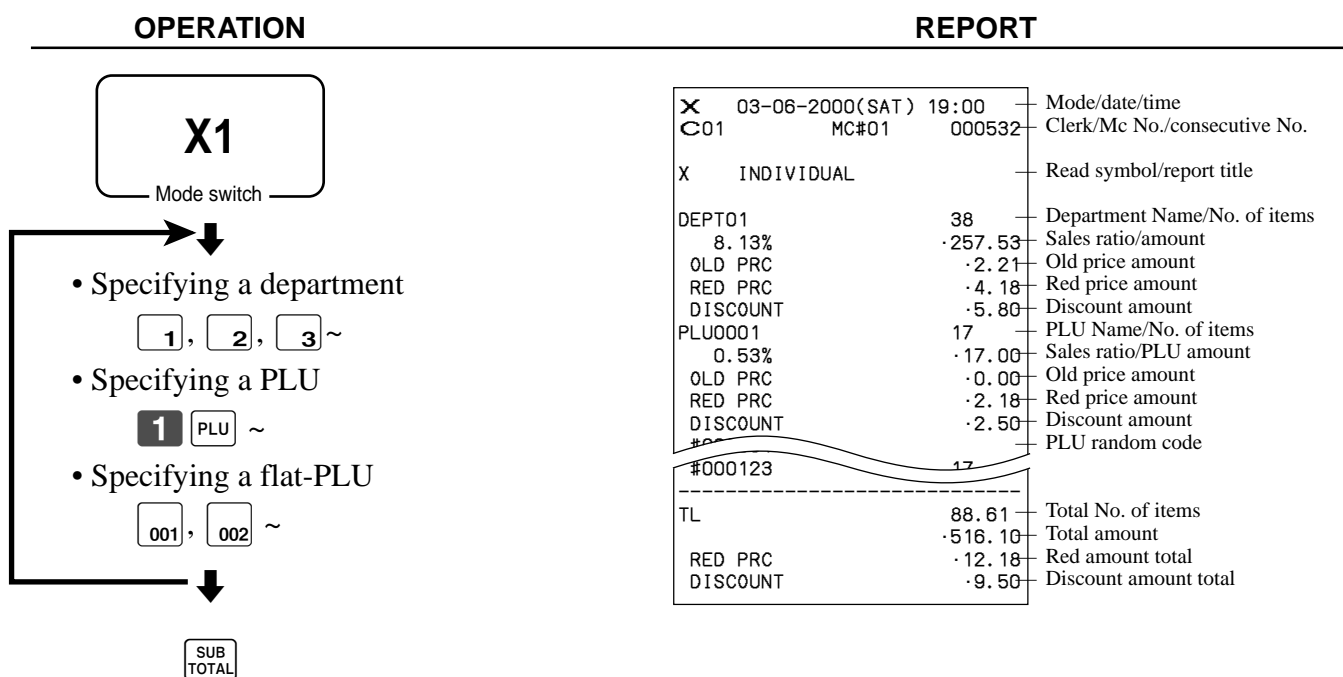

After you finish to select items, press  to terminate.

## To print the financial read report

This report shows gross sales, net sales, cash in drawer and check in drawer.

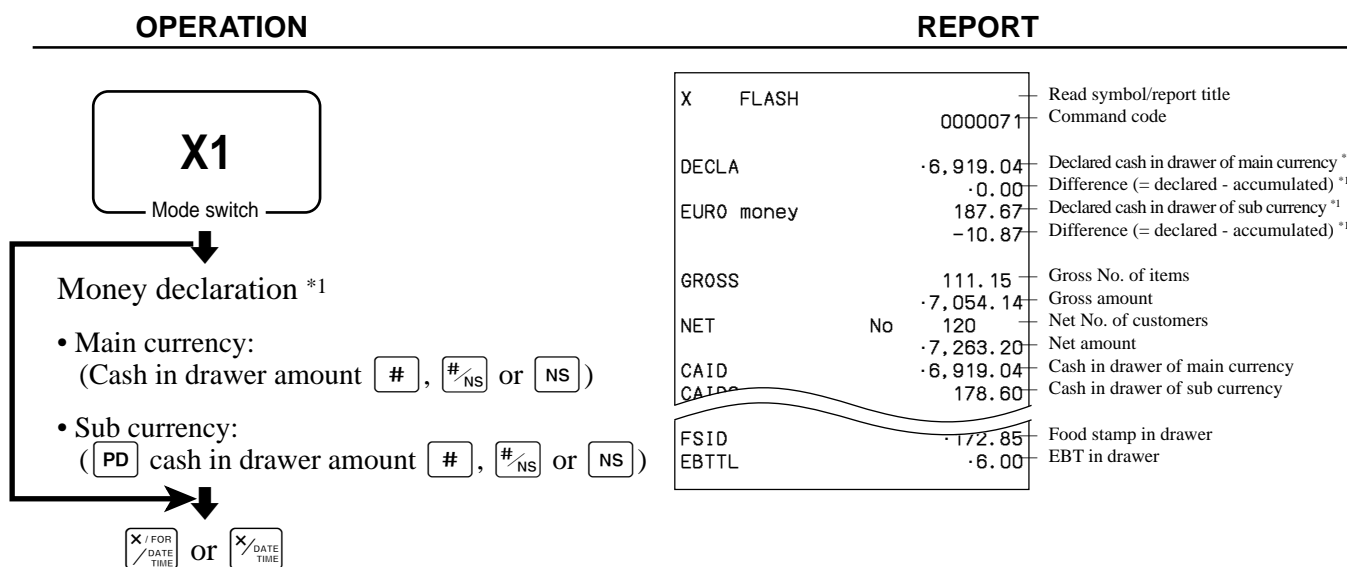

## To print the individual clerk read/reset report

This report shows individual clerk totals.

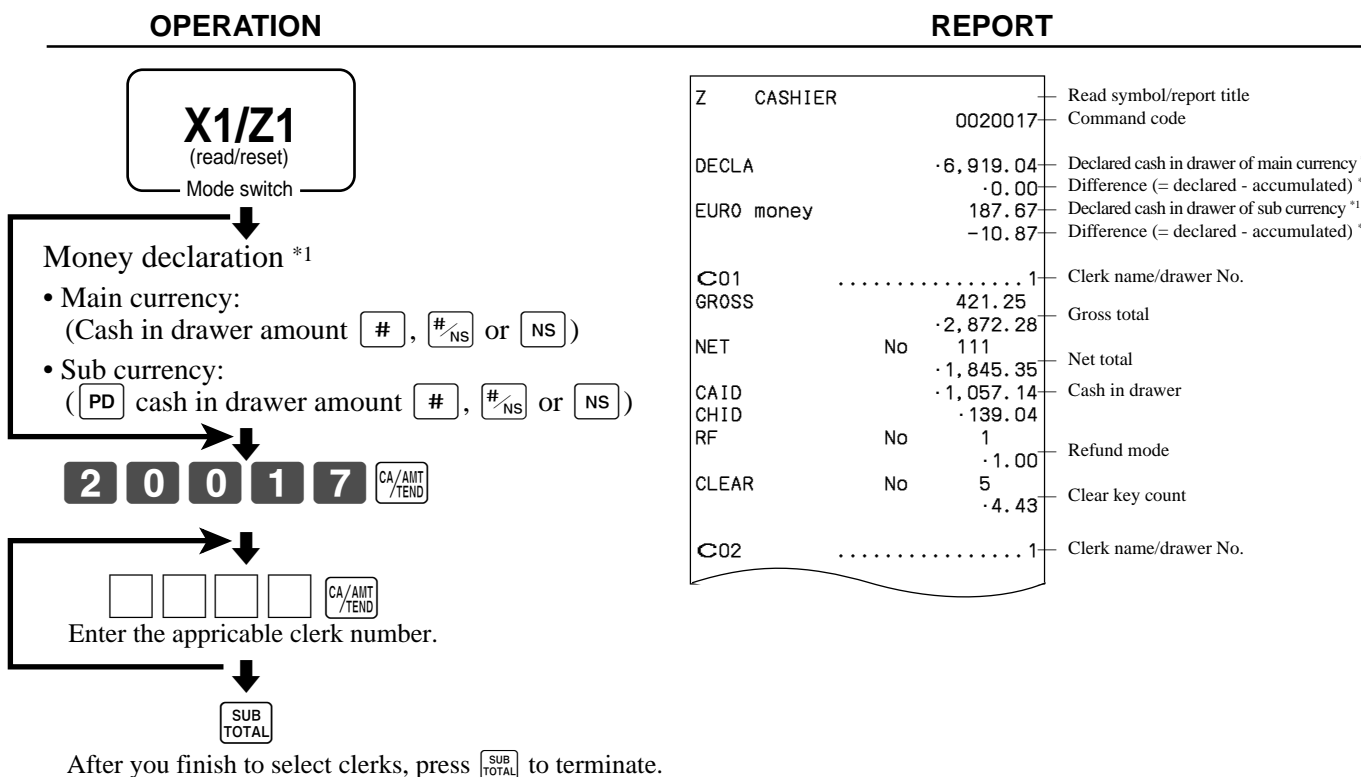

\*1 Money declaration:

Count how much cash is in the drawer and input this amount (up to 10 digits).

The cash register will automatically compare the input with the cash in drawer in the memory and print the difference between these two amounts.

Note that if money declaration is required by programming, you cannot skip this procedure.

# Advanced Operations

## To print the daily sales read/reset report

This report shows sales except for PLUs.

### OPERATION

### REPORT

**X1/Z1**

(read/reset)

Mode switch

Money declaration \*1

• Main currency:  
(Cash in drawer amount  ,  or  )

• Sub currency:  
(  cash in drawer amount  ,  or  )

CA / AMT  
/ TEND

Z	BATCH 01		Report title
Z	FIX	0001	Fixed total report title/reset counter *4
		0001011	Report code
DECLA		·6,919.04	Declared cash in drawer of main currency *1
		·0.00	Difference (= declared - accumulated) *1
EURO money		187.67	Declared cash in drawer of sub currency *1
		-10.87	Difference (= declared - accumulated) *1
GROSS		981.25	Gross total *3
		·6,574.40	
NET	No	111	Net total *3
		·7,057.14	
CAID		·6,919.04	Cash in drawer *3
CHID		·139.04	Charge in drawer *3
CKID		·859.85	Check in drawer *3
CRID(1)		·709.85	Credit in drawer *3
RF	No	3	Refund mode *3
		·10.22	
CUST	CT	111	Customer number *3
AVRG		·63.57	Average sales per customer *3
DC		·1.22	Discount total *3
REF		·2.42	Refund key *3
CLEAR	No	85	Clear key count *3
ROUND		·0.00	Rounding total *3
CANCEL	No	2	Cancellation *3
		·12.97	
TA1		·2,369.69	Taxable 1 amount *3
TX1		·128.86	Tax 1 amount *3
TA2		·2,172.96	Taxable 2 amount *3
TX2		·217.33	Tax 2 amount *3
GT1		·00000000125478.96	Grand total 1 *3
GT2		·00000000346284.23	Grand total 2 *3
GT3		·00000000123212.75	Grand total 3 *3



Z	TRANS		0001	Function key report title/reset counter
			0001012	Report code
CASH	No	362		Function key count/amount *2
		-1,638.04		
CHARGE	No	56		
		-1,174.85		
RC	No	4		
		-810.00		
PD	No	5		
		-520.00		
CORR	No	14		
		-39.55		
VLD	No	19		
RCT	No	3		
NS	No	5		
-----				
Z	DEPT		0001	Department report title/reset counter
			0001015	Report code
DEPT01		38		Department name/No. of items *2
8.13%		-257.53		Sales ratio/amount *2
OLD PRC		-2.21		Old price amount *2
RED PRC		-4.18		Red price amount *2
DISCOUNT		-5.80		Discount amount *2
DEPT02		183		
		-1,362.20		
RED PRC		-20.21		
DISCOUNT		-17.22		
-----				
TL		88.61		Total No. of items
		-1,916.10		Total amount
RED PRC		-12.18		Red amount total
DISCOUNT		-9.50		Discount amount total
-----				
Z	CASHIER		0001	Clerk report title/reset counter
			0001017	Report code
C01	.....	1		Clerk name/drawer No.
GROSS		421.25		Gross total
		-2,872.28		
NET	No	111		Net total
		-1,845.35		
CAID		-1,057.14		Cash in drawer
CHID		-139.04		
RF	No	1		Refund mode
		-1.00		
CLEAR	No	5		Clear key count
		-4.43		
C02	.....	1		Clerk name/drawer No.

\*1 Money declaration:

Count how much cash is in the drawer and input this amount (up to 10 digits).

The cash register will automatically compare the input with the cash in drawer in the memory and print the difference between these two amounts.

Note that if money declaration is required by programming, you cannot skip this procedure.

\*2 Zero totalled departments/functions (the amount and item numbers are both zero) are not printed.

\*3 These items can be skipped by programming.

\*4 The “\*” symbol is printed on the reset report, memory overflow occurred in the counter/totalizer.

# Advanced Operations

## To print the PLU/flat-PLU read/reset report

This report shows sales for PLUs.

OPERATION	REPORT																																																																																															
<div style="border: 1px solid black; padding: 5px; width: fit-content; margin: 0 auto;"> <p><b>X1/Z1</b> (read/reset)</p> <p>Mode switch</p> </div> <p style="text-align: center;">↓</p> <div style="display: flex; justify-content: center; gap: 10px; align-items: center;"> <div style="border: 1px solid black; padding: 2px 10px; font-weight: bold;">0</div> <div style="border: 1px solid black; padding: 2px 10px; font-weight: bold;">1</div> <div style="border: 1px solid black; padding: 2px 10px; font-weight: bold;">4</div> <div style="border: 1px solid black; padding: 2px 5px; font-size: 8px;">CA/AMT /TEND</div> </div>	<table border="1" style="width: 100%; border-collapse: collapse;"> <tbody> <tr> <td>X</td> <td>PLU</td> <td></td> <td>0000014</td> <td>Read symbol/report title</td> </tr> <tr> <td></td> <td></td> <td></td> <td></td> <td>Report code</td> </tr> <tr> <td>PLU0001</td> <td></td> <td>17</td> <td></td> <td>PLU name/No. of items</td> </tr> <tr> <td>0.53%</td> <td></td> <td>.17.00</td> <td></td> <td>Sales ratio/PLU amount</td> </tr> <tr> <td>OLD PRC</td> <td></td> <td>.0.00</td> <td></td> <td>Old price amount</td> </tr> <tr> <td>RED PRC</td> <td></td> <td>.2.18</td> <td></td> <td>Red price amount</td> </tr> <tr> <td>DISCOUNT</td> <td></td> <td>.2.50</td> <td></td> <td>Discount amount</td> </tr> <tr> <td>#000001</td> <td></td> <td></td> <td></td> <td>PLU random code</td> </tr> <tr> <td>PLU0100</td> <td></td> <td>42</td> <td></td> <td></td> </tr> <tr> <td>4.03%</td> <td></td> <td>.69.00</td> <td></td> <td></td> </tr> <tr> <td>OLD PRC</td> <td></td> <td>.0.00</td> <td></td> <td></td> </tr> <tr> <td>RED PRC</td> <td></td> <td>.5.18</td> <td></td> <td></td> </tr> <tr> <td>DISCOUNT</td> <td></td> <td>.0.00</td> <td></td> <td></td> </tr> <tr> <td>#000100</td> <td></td> <td></td> <td></td> <td></td> </tr> <tr> <td colspan="4" style="border-top: 1px dashed black;"></td> <td></td> </tr> <tr> <td>TL</td> <td></td> <td>188.61</td> <td></td> <td>Total No. of items</td> </tr> <tr> <td></td> <td></td> <td>.516.10</td> <td></td> <td>Total amount</td> </tr> <tr> <td>RED PRC</td> <td></td> <td>.12.18</td> <td></td> <td>Red amount total</td> </tr> <tr> <td>DISCOUNT</td> <td></td> <td>.9.50</td> <td></td> <td>Discount amount total</td> </tr> </tbody> </table>	X	PLU		0000014	Read symbol/report title					Report code	PLU0001		17		PLU name/No. of items	0.53%		.17.00		Sales ratio/PLU amount	OLD PRC		.0.00		Old price amount	RED PRC		.2.18		Red price amount	DISCOUNT		.2.50		Discount amount	#000001				PLU random code	PLU0100		42			4.03%		.69.00			OLD PRC		.0.00			RED PRC		.5.18			DISCOUNT		.0.00			#000100										TL		188.61		Total No. of items			.516.10		Total amount	RED PRC		.12.18		Red amount total	DISCOUNT		.9.50		Discount amount total
X	PLU		0000014	Read symbol/report title																																																																																												
				Report code																																																																																												
PLU0001		17		PLU name/No. of items																																																																																												
0.53%		.17.00		Sales ratio/PLU amount																																																																																												
OLD PRC		.0.00		Old price amount																																																																																												
RED PRC		.2.18		Red price amount																																																																																												
DISCOUNT		.2.50		Discount amount																																																																																												
#000001				PLU random code																																																																																												
PLU0100		42																																																																																														
4.03%		.69.00																																																																																														
OLD PRC		.0.00																																																																																														
RED PRC		.5.18																																																																																														
DISCOUNT		.0.00																																																																																														
#000100																																																																																																
TL		188.61		Total No. of items																																																																																												
		.516.10		Total amount																																																																																												
RED PRC		.12.18		Red amount total																																																																																												
DISCOUNT		.9.50		Discount amount total																																																																																												

## To print the hourly sales read/reset report

This report shows hourly breakdowns of sales.

OPERATION	REPORT																																																																																					
<div style="border: 1px solid black; padding: 5px; width: fit-content; margin: 0 auto;"> <p><b>X1/Z1</b> (read/reset)</p> <p>Mode switch</p> </div> <p style="text-align: center;">↓</p> <div style="display: flex; justify-content: center; gap: 10px; align-items: center;"> <div style="border: 1px solid black; padding: 2px 10px; font-weight: bold;">0</div> <div style="border: 1px solid black; padding: 2px 10px; font-weight: bold;">1</div> <div style="border: 1px solid black; padding: 2px 10px; font-weight: bold;">9</div> <div style="border: 1px solid black; padding: 2px 5px; font-size: 8px;">CA/AMT /TEND</div> </div>	<table border="1" style="width: 100%; border-collapse: collapse;"> <tbody> <tr> <td>X</td> <td>HOURLY</td> <td></td> <td>0000019</td> <td>Read symbol/report title</td> </tr> <tr> <td></td> <td></td> <td></td> <td></td> <td>Report code</td> </tr> <tr> <td>00:00-&gt;01:00</td> <td></td> <td></td> <td></td> <td>Time range</td> </tr> <tr> <td></td> <td>CT</td> <td>1</td> <td></td> <td>No. of customers</td> </tr> <tr> <td>GROSS</td> <td></td> <td>.1.10</td> <td></td> <td>Gross sales amount</td> </tr> <tr> <td>NET</td> <td>No</td> <td>1</td> <td></td> <td>No. of receipt</td> </tr> <tr> <td>1.90%</td> <td></td> <td>.1.20</td> <td></td> <td>Sales ratio/net sales amount</td> </tr> <tr> <td>23:00-&gt;00:00</td> <td></td> <td></td> <td></td> <td></td> </tr> <tr> <td></td> <td>CT</td> <td>1</td> <td></td> <td></td> </tr> <tr> <td>GROSS</td> <td></td> <td>.3.45</td> <td></td> <td></td> </tr> <tr> <td>NET</td> <td></td> <td>.1.00</td> <td></td> <td></td> </tr> <tr> <td>3.90%</td> <td></td> <td>.3.59</td> <td></td> <td></td> </tr> <tr> <td colspan="4" style="border-top: 1px dashed black;"></td> <td></td> </tr> <tr> <td>TL</td> <td>CT</td> <td>280</td> <td></td> <td>Total No. of customers</td> </tr> <tr> <td>GROSS</td> <td></td> <td>.1,937.61</td> <td></td> <td>Gross total amount</td> </tr> <tr> <td>NET</td> <td>No</td> <td>25</td> <td></td> <td>Total No. of receipt</td> </tr> <tr> <td></td> <td></td> <td>.2,096.80</td> <td></td> <td>Net total amount</td> </tr> </tbody> </table>	X	HOURLY		0000019	Read symbol/report title					Report code	00:00->01:00				Time range		CT	1		No. of customers	GROSS		.1.10		Gross sales amount	NET	No	1		No. of receipt	1.90%		.1.20		Sales ratio/net sales amount	23:00->00:00						CT	1			GROSS		.3.45			NET		.1.00			3.90%		.3.59								TL	CT	280		Total No. of customers	GROSS		.1,937.61		Gross total amount	NET	No	25		Total No. of receipt			.2,096.80		Net total amount
X	HOURLY		0000019	Read symbol/report title																																																																																		
				Report code																																																																																		
00:00->01:00				Time range																																																																																		
	CT	1		No. of customers																																																																																		
GROSS		.1.10		Gross sales amount																																																																																		
NET	No	1		No. of receipt																																																																																		
1.90%		.1.20		Sales ratio/net sales amount																																																																																		
23:00->00:00																																																																																						
	CT	1																																																																																				
GROSS		.3.45																																																																																				
NET		.1.00																																																																																				
3.90%		.3.59																																																																																				
TL	CT	280		Total No. of customers																																																																																		
GROSS		.1,937.61		Gross total amount																																																																																		
NET	No	25		Total No. of receipt																																																																																		
		.2,096.80		Net total amount																																																																																		

## To print the monthly sales read/reset report

This report shows monthly breakdowns of sales.

OPERATION	REPORT																																																																																				
<div style="border: 1px solid black; padding: 5px; display: inline-block;"> <b>X1/Z1</b>                      (read/reset)                      Mode switch                 </div> <div style="display: flex; justify-content: center; align-items: center; gap: 10px;"> <div style="border: 1px solid black; padding: 2px 5px; font-weight: bold;">0</div> <div style="border: 1px solid black; padding: 2px 5px; font-weight: bold;">2</div> <div style="border: 1px solid black; padding: 2px 5px; font-weight: bold;">0</div> <div style="border: 1px solid black; padding: 2px 5px; font-size: 8px;">CA/AMT /TEND</div> </div>	<table border="1" style="width: 100%; border-collapse: collapse;"> <tr> <td style="width: 10%;">X</td> <td style="width: 40%;">MONTHLY</td> <td style="width: 10%;">0000020</td> <td style="width: 40%;">Read symbol/report title</td> </tr> <tr> <td></td> <td></td> <td></td> <td>Report code</td> </tr> <tr> <td></td> <td>1.....</td> <td></td> <td>Date of a month</td> </tr> <tr> <td></td> <td>GROSS</td> <td>1236.76</td> <td>Gross symbol/No. of items</td> </tr> <tr> <td></td> <td></td> <td>· 12,202.57</td> <td>Gross sales amount</td> </tr> <tr> <td></td> <td>NET</td> <td>No 214</td> <td>Net symbol/No. of customers</td> </tr> <tr> <td></td> <td></td> <td>· 12,202.57</td> <td>Net sales amount</td> </tr> <tr> <td colspan="4" style="text-align: center;">-----</td> </tr> <tr> <td></td> <td>01.....</td> <td></td> <td>Total symbol</td> </tr> <tr> <td></td> <td>GROSS</td> <td>2132</td> <td>Gross symbol/No. of items</td> </tr> <tr> <td></td> <td></td> <td>· 14,187.57</td> <td>Gross sales amount</td> </tr> <tr> <td></td> <td>NET</td> <td>No 205</td> <td>Average daily gross sales</td> </tr> <tr> <td></td> <td></td> <td>· 13,398.76</td> <td>Net symbol/No. of customers</td> </tr> <tr> <td colspan="4" style="text-align: center;">-----</td> </tr> <tr> <td></td> <td>TL</td> <td></td> <td>Total symbol</td> </tr> <tr> <td></td> <td>GROSS</td> <td>9746.63</td> <td>Gross symbol/No. of items</td> </tr> <tr> <td></td> <td></td> <td>· 161,022.49</td> <td>Gross sales amount</td> </tr> <tr> <td></td> <td></td> <td>· 16.52</td> <td>Average daily gross sales</td> </tr> <tr> <td></td> <td>NET</td> <td>No 2351</td> <td>Net symbol/No. of customers</td> </tr> <tr> <td></td> <td></td> <td>· 161,022.49</td> <td>Net sales amount</td> </tr> <tr> <td></td> <td></td> <td>· 68.49</td> <td>Average daily net sales</td> </tr> </table>	X	MONTHLY	0000020	Read symbol/report title				Report code		1.....		Date of a month		GROSS	1236.76	Gross symbol/No. of items			· 12,202.57	Gross sales amount		NET	No 214	Net symbol/No. of customers			· 12,202.57	Net sales amount	-----					01.....		Total symbol		GROSS	2132	Gross symbol/No. of items			· 14,187.57	Gross sales amount		NET	No 205	Average daily gross sales			· 13,398.76	Net symbol/No. of customers	-----					TL		Total symbol		GROSS	9746.63	Gross symbol/No. of items			· 161,022.49	Gross sales amount			· 16.52	Average daily gross sales		NET	No 2351	Net symbol/No. of customers			· 161,022.49	Net sales amount			· 68.49	Average daily net sales
X	MONTHLY	0000020	Read symbol/report title																																																																																		
			Report code																																																																																		
	1.....		Date of a month																																																																																		
	GROSS	1236.76	Gross symbol/No. of items																																																																																		
		· 12,202.57	Gross sales amount																																																																																		
	NET	No 214	Net symbol/No. of customers																																																																																		
		· 12,202.57	Net sales amount																																																																																		
-----																																																																																					
	01.....		Total symbol																																																																																		
	GROSS	2132	Gross symbol/No. of items																																																																																		
		· 14,187.57	Gross sales amount																																																																																		
	NET	No 205	Average daily gross sales																																																																																		
		· 13,398.76	Net symbol/No. of customers																																																																																		
-----																																																																																					
	TL		Total symbol																																																																																		
	GROSS	9746.63	Gross symbol/No. of items																																																																																		
		· 161,022.49	Gross sales amount																																																																																		
		· 16.52	Average daily gross sales																																																																																		
	NET	No 2351	Net symbol/No. of customers																																																																																		
		· 161,022.49	Net sales amount																																																																																		
		· 68.49	Average daily net sales																																																																																		

## To print the group read/reset report

This report shows PLU/subdepartment/department group totals.

OPERATION	REPORT																																																								
<div style="border: 1px solid black; padding: 5px; display: inline-block;"> <b>X1/Z1</b>                      (read/reset)                      Mode switch                 </div> <div style="display: flex; justify-content: center; align-items: center; gap: 10px;"> <div style="border: 1px solid black; padding: 2px 5px; font-weight: bold;">0</div> <div style="border: 1px solid black; padding: 2px 5px; font-weight: bold;">1</div> <div style="border: 1px solid black; padding: 2px 5px; font-weight: bold;">6</div> <div style="border: 1px solid black; padding: 2px 5px; font-size: 8px;">CA/AMT /TEND</div> </div>	<table border="1" style="width: 100%; border-collapse: collapse;"> <tr> <td style="width: 10%;">X</td> <td style="width: 40%;">GROUP</td> <td style="width: 10%;">0000016</td> <td style="width: 40%;">Read symbol/report title</td> </tr> <tr> <td></td> <td></td> <td></td> <td>Report code</td> </tr> <tr> <td></td> <td>GROUP01</td> <td>203.25</td> <td>Group No./No. of items</td> </tr> <tr> <td></td> <td>33.87%</td> <td>· 1,108.54</td> <td>Sales ratio/group amount</td> </tr> <tr> <td></td> <td>GROUP02</td> <td>183</td> <td></td> </tr> <tr> <td></td> <td>40.58%</td> <td>· 1,327.80</td> <td></td> </tr> <tr> <td></td> <td>GROUP03</td> <td>12</td> <td></td> </tr> <tr> <td></td> <td></td> <td>· 13.25</td> <td></td> </tr> <tr> <td colspan="4" style="text-align: center;">-----</td> </tr> <tr> <td></td> <td>GROUP99</td> <td>13</td> <td></td> </tr> <tr> <td></td> <td>0.54%</td> <td>· 17.80</td> <td></td> </tr> <tr> <td colspan="4" style="text-align: center;">-----</td> </tr> <tr> <td></td> <td>TL</td> <td>862</td> <td>Group total No. of items</td> </tr> <tr> <td></td> <td></td> <td>· 3,272.00</td> <td>Group total amount</td> </tr> </table>	X	GROUP	0000016	Read symbol/report title				Report code		GROUP01	203.25	Group No./No. of items		33.87%	· 1,108.54	Sales ratio/group amount		GROUP02	183			40.58%	· 1,327.80			GROUP03	12				· 13.25		-----					GROUP99	13			0.54%	· 17.80		-----					TL	862	Group total No. of items			· 3,272.00	Group total amount
X	GROUP	0000016	Read symbol/report title																																																						
			Report code																																																						
	GROUP01	203.25	Group No./No. of items																																																						
	33.87%	· 1,108.54	Sales ratio/group amount																																																						
	GROUP02	183																																																							
	40.58%	· 1,327.80																																																							
	GROUP03	12																																																							
		· 13.25																																																							
-----																																																									
	GROUP99	13																																																							
	0.54%	· 17.80																																																							
-----																																																									
	TL	862	Group total No. of items																																																						
		· 3,272.00	Group total amount																																																						

# Advanced Operations

## • Periodic sales read report (“X2” mode)

You can print read reports at any time during the business day without affecting the data stored in the cash register's memory.

## • Periodic sales reset report (“Z2” mode)

You should print reset reports at the end of the business day.

## To print the periodic 1/2 sales read/reset reports

These reports show sales breakdowns of sales by any two kinds of period you want.

### OPERATION

### REPORT

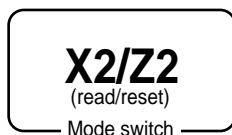

**1** CA/AMT /TEND

-----			
ZZ1	BATCH 02		Report title
-----			
ZZ1	FIX	0001	Fixed total report title/reset counter
		0001111	Report code
-----			
GRASS		981.25	Gross total *2
		-6,574.40	
NET	No	111	Net total *2
		-7,057.14	
CAID		-6,919.04	Cash in drawer *2
CHID		-139.04	Charge in drawer *2
CKID		-859.85	Check in drawer *2
CRID(1)		-709.85	Credit in drawer *2
-----			
RF	No	3	Refund mode *2
		-10.22	
CUST	CT	111	Customer number *2
AVRG		-63.57	Average sales per customer *2
DC		-1.22	Discount total *2
REF		-2.42	Refund key *2
CLEAR	No	85	Clear key count *2
ROUND		-0.00	Rounding total *2
CANCEL	No	2	Cancellation *2
		-12.97	
-----			
TA1		-2,369.69	Taxable 1 amount *2
TX1		-128.86	Tax 1 amount *2
TA2		-2,172.96	Taxable 2 amount *2
TX2		-217.33	Tax 2 amount *2
-----			
ZZ1	TRANS	0001	Function key report title/reset counter
		0001112	Report code
CASH	No	362	Function key count/amount *1
		-1,638.04	
CHARGE	No	56	
		-1,174.85	
RC	No	4	
		-810.00	
PD	No	5	
		-5.00	
CORR		14	
		-39.55	
VLD	No	19	
RCT	No	3	
NS	No	5	
-----			

ZZ1 DEPT		0001	Department report title/reset counter
		0001115	Report code
DEPT01		38	Department Name/No. of items *1
8.13%		.257.53	Sales ratio/amount *1
OLD PRC		.2.21	Old price amount *1
RED PRC		.4.18	Red price amount *1
DISCOUNT		.5.80	Discount amount *1
DEPT02		183	
		.1,362.26	
OLD PRC		.123.21	
DISCOUNT		.7.22	
-----			
TL		88.61	Total No. of items
		.1,916.10	Total amount
RED PRC		.12.18	Red amount total
DISCOUNT		.9.50	Discount amount total
-----			
ZZ1 CASHIER		0001	Clerk report title/reset counter
		0001117	Report code
C01	.....	1	Clerk name/drawer No.
GROSS		421.25	Gross total
		.2,872.28	
NET	No	111	Net total
		.1,845.35	
CAID		.1,057.14	Cash in drawer
CHID		.139.04	
RF	No	1	Refund mode
		.1.00	
CLEAR	No	5	Clear key count
		.4.43	
C02	.....	1	Clerk name/drawer No.

\*1 Zero totalled departments/functions (the amount and item numbers are both zero) are not printed.

\*2 These items can be skipped by programming.

# Advanced Operations

## To print other sales read/reset reports

The following reports can be issued.

### Procedure

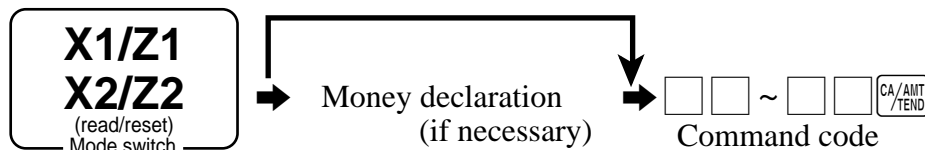

### Report/command code list

Report name	Command code			Report name	Command code		
	# = 0 (read)	# = 1 (reset)			# = 0 (read)	# = 1 (reset)	
	Daily	Periodic 1	Periodic 2		Daily	Periodic 1	Periodic 2
Fix totalizer	11	#111	#211	Department	15	#115	#215
Transaction key	12	#112	#212	best 50 (amount order)	60015	60115	60215
Subdepartment	13	#113	#213	best 50 (quantity order)	70015	70115	70215
PLU by record number (all) *	14	#114	#214	Group	16	#116	#216
all PLU by random code *	14	#114	#214	Clerk	17	#117	#217
by group	1000014	100#114	100#214	individual	20017	2#117	2#217
by department	2000014	200#114	200#214	Hourly sales	19	#119	#219
by subdepartment	3000014	300#114	300#214	Monthly sales	20	#120	#220
individual by group	1020014	102#114	102#214	Open check	25	----	----
individual by department	2020014	202#114	202#214	total	40025	----	----
individual by subdepartment	3020014	302#114	302#214	Scanning PLU by range department (all)	26	----	----
range by record number *	10014	1#114	1#214	by range group	1000026	----	----
range by random code *	10014	1#114	1#214	by range department	2000026	----	----
best 50 (amount order)	60014	60114	60214	by range subdepartment	3000026	----	----
best 50 (quantity order)	70014	70114	70214	best 50 by range department	80026	----	----
menu (1st)	81	#181	#281	inactive item by range department	90026	----	----
menu (2nd)	82	#182	#282	Not found PLU by range department (all)	27	----	----
menu (3rd)	83	#183	#283	Table analysis	28	#128	#228
menu (4th)	84	#184	#284	Hourly item	31	#131	#231
menu (5th)	85	#185	#285	Mix & match	61	#161	#261
menu (6th)	86	#186	#286	Financial	71	----	----
PLU stock all PLU by record number *	64	----	----	Individual (item / transaction key)	No code	----	----
all by random PLU code *	64	----	----	PLU reset (no report)	50014	51114	51214
by group	1000064	----	----	Scanning PLU reset (no report)	50026	----	----
by department	2000064	----	----	Not found PLU reset (no report)	50027	----	----
by subdepartment	3000064	----	----	Not found PLU file reset (incl. program)	80027	----	----
individual by group	1020064	----	----	Not found PLU maintenance file reset	80082	----	----
individual by department	2020064	----	----				
individual by subdepartment	3020064	----	----				
range by record number *	10064	----	----				
range by random code *	10064	----	----				

\* You can choose by record number / random code by program.

# Reading the cash register's program

To print unit price/rate program (except PLU/scanning PLU)

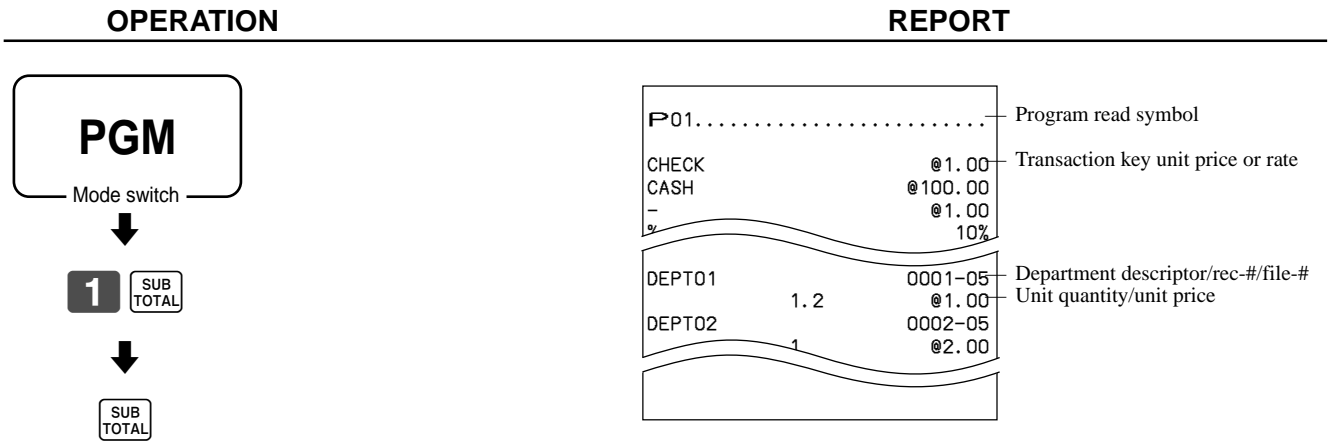

# Advanced Operations

## To print key descriptor, name, message program (except PLU)

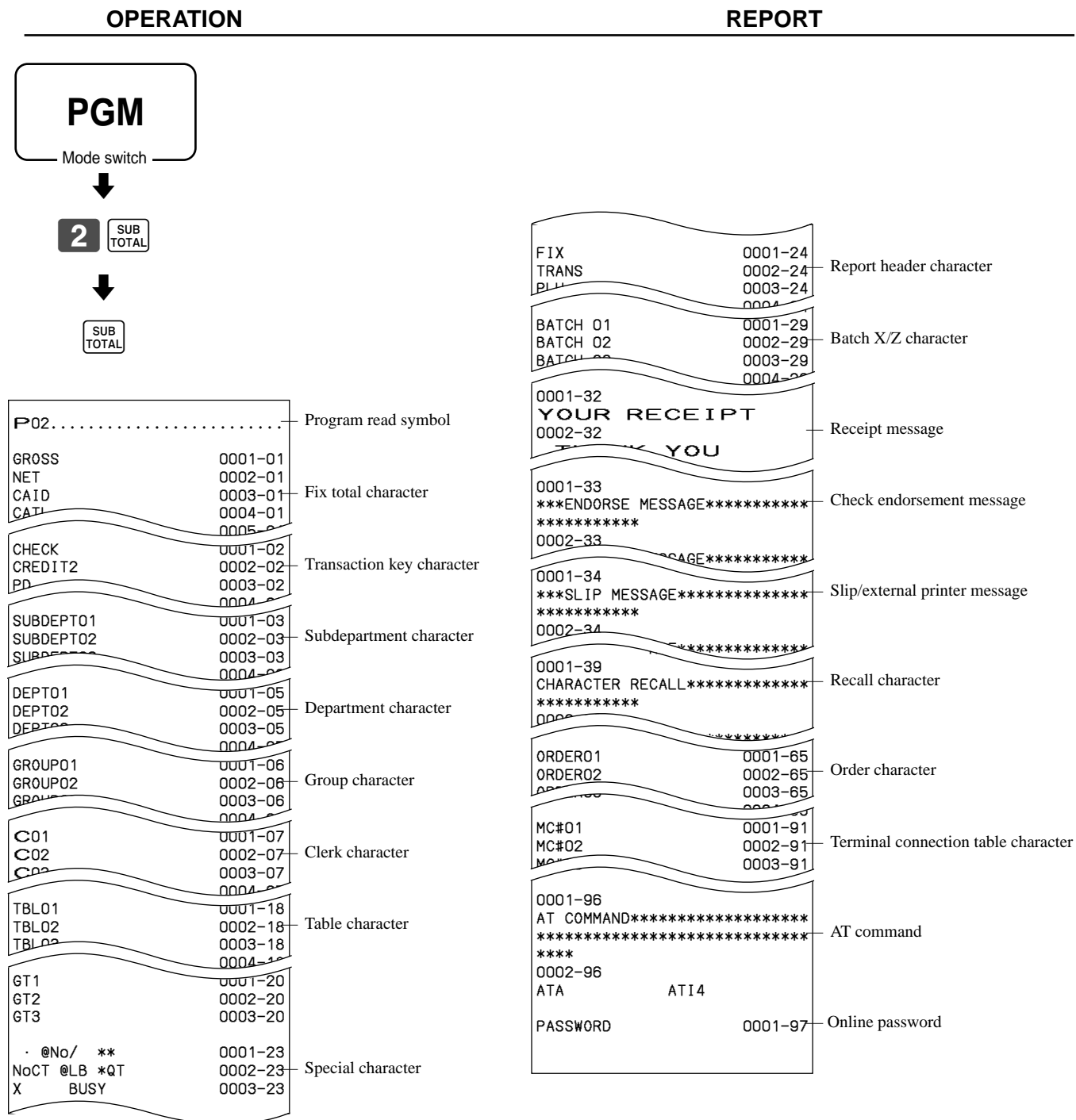



# To print the PLU/flat-PLU program

## OPERATION

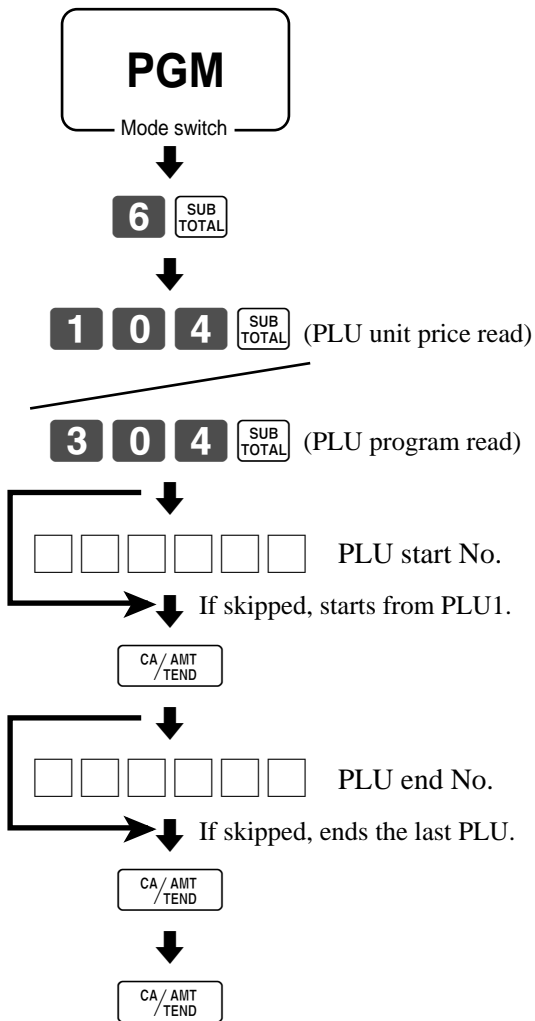

## REPORT

P01.....	Program read symbol
#000001 - #999999	Read range
PLU0001	0001-04 Item character/rec-#/file-#
	#000001 Random code
1.2	@1.00 Unit quantity/unit price
PLU0002	0002-04
	#000002
1	@2.00
-----	
P03.....	Program read symbol
#000001 - #999999	Read range
PLU0001	0001-04 Item character/rec-#/file-#
	0000000000000000 Batch program 01 ~ 1066, 18 ~ 1966
11-66	000000 Batch program 1166
12-66	#000001 Batch program 1266
13-66	<- 0001-28 Batch program 1366
14-66	0 Batch program 1466
15-66	@1234.56 Batch program 1566
16-66	000000 Batch program 1666
17-66	00 Batch program 1766
PLU0002	0002-04
	0000000000000000
11-66	000000

# Troubleshooting

This section describes what to do when you have problems with operation.

## When an error occurs

Errors are indicated by an error codes. When this happens, you can usually find out what the problem is as illustrated below.

Press **C** and check the appropriate section of this manual for the operation you want to perform.

Error code	Message	Meaning	Action
E001	Wrong mode	Mode switch position changed before finalization.	Return the mode switch to its original setting and finalize the operation.
E003	Wrong operator	Clerk button pressed before finalization of a registration being performed under another clerk button. The signed on clerk differs from the clerk performed the tracking check registration.	Press the original clerk button and finalize the transaction before pressing another clerk button. Input correct check number or assign the proper clerk number.
E004	Error INIT/FC	Initialization or unit lock clear operation in progress.	Complete operation.
E005	Insufficient memory	Memory allocation exceeds total memory capacity.	Reallocate memory or expand memory (if possible).
E008	Please sign on	Registration without entering a clerk number.	Enter a clerk number.
E009	Enter password	Operation without entering the password.	Enter password.
E010	Close the drawer	The drawer is left open longer than the program time (drawer open alarm).	Close the drawer.
E011	Close the drawer	Attempt to register while the cash drawer is open.	Shut the cash drawer.
E015	Check R/J printer	Printer error	
E016	Change back to REB mode	Two consecutive transactions attempted in the refund mode.	Switch to another mode and then back to the RF mode for the next transaction.
E017	Enter CHK/TBL number	Attempt made to register an item without inputting a check number.	Input a check number.
E018	Enter Table number	Attempt made to register an item without inputting a table number.	Input a table number.
E019	Enter number of customers	Finalize operation attempted without entering the number of customer.	Enter the number of customer.
E021	No Dept Link	No department linked PLU is registered.	Correct the program.
E023	Stock shortage	Actual stock quantity becomes less than the minimum stock quantity.	Perform stock maintenance.
E024	No stock	Actual stock quantity becomes/is negative.	Perform stock maintenance.
E025	Illegal scale read or entry	Scale read error/perform non-scale registration to scalable item.	Retry registration/register to a proper department or PLU.
E026	Enter condiment/preparation PLU	No condiment/preparation PLU is registered.	Register condiment/preparation PLU.
E029	In the tender operation	Item registration is prohibited, while partial tender.	Finalize the transaction.
E030	Press RATE TAX key	Finalization of a transaction attempted without registering rate-tax.	Register <RATE TAX>.
E031	Press ST key	Finalization of a transaction attempted without confirming the subtotal.	Press <SUBTOTAL>.
E032	Press FSST key	Finalization of a transaction attempted without confirming of the food stamp subtotal.	Press <FS/ST>.
E033	Enter tendered amount	Finalize operation attempted without entering amount tender.	Enter the amount tendered.
E035	Change amount exceeds limit	Change amount exceeds preset limit.	Input amount tendered again.
E036	Remove money from the drawer	Contents of the drawer exceed programmed limit.	Perform pick up operation.
E037	Digit or amount limitation over	High amount lock out/low digit lock out error	Enter correct amount.
E038	Perform money declaration	Read/reset operation without declaring cash in drawer. This error appears only when this function is activated.	Perform money declaration.
E040	Issue guest receipt	Attempt to register a new transaction without issuing a guest receipt.	Issue a guest receipt.
E041	Print validation	Attempt to register a new transaction without validation.	Perform validation operation.
E042	Insert VLD paper and retry	Validation paper (slip printer) has run out.	Insert new validation paper.
E044	Print cheque	Attempt to register a new transaction without printing check.	Perform check print.
E045	Print Check Endorsement	Attempt to register a new transaction without printing check endorsement.	Perform check endorsement.

# Troubleshooting

Error code	Message	Meaning	Action
E046	REG buffer full	Registration buffer full. Separate check buffer full.	Finalize the transaction. Allocate sufficient separate check buffer.
E047	Print bill	Attempt to register a new transaction without printing slip.	Perform slip printing operation.
E048	Insert slip paper and retry	No paper is inserted or paper is out in the slip printer.	Insert new slip paper.
E049	CHECK memory full	Check tracking index memory full.	Finalize and close the check number currently used.
E050	DETAIL memory full	Check tracking detail memory full.	Finalize and close the check number currently used.
E051	CHK/TBL No. is occupied	Attempt to made use <New Check> to open a new check using a number that is already used for an existing check in check tracking memory.	Finalize and close the check that is currently under the number that you want to use or use a different check number.
E053	CHK/TBL No. is not opened	Attempt made to use <Old Check> reopen a new check using a number that is not used for an existing check in check tracking memory.	Use the correct check number (if you want to reopen a check that already exists in check tracking memory) or use <New Check> to open a new check.
E054	Out of CHK/TBL No. range	Check number range over.	Enter correct number.
E055	In the SEP CHK operation	Normal registration is prohibited during separate check operation.	Terminate separate check operation.
E059	Press EAT-IN or TAKE-OUT key	Attempt to finalize a transaction without specifying <EAT-IN> or <TAKE-OUT>.	Press <EAT-IN> or <TAKE-OUT>.
E060	Printer offline	External printer offline	
E061	Printer error	External printer went down.	
E062	Printer paper end	External printer paper end	Replace new paper.
E063	Printer busy	External printer is now printing.	
E064	Print buffer full	Printing buffer full	
E066	Print from the beginning of the transaction	Attempt to print the last separated transaction on slip.	Print from the beginning of the transaction
E075	Negative balance cannot be finalized	Attempt to finalize a transaction when balance is less than or equal to zero.	Register item(s) until the balance becomes positive amount.
E085	Data exist in consolidation file	Data exists in the consolidation file.	Clear the data.
E099	Check NFP items	Disable to read/reset or consolidate the not found PLU item.	
E100	Operate at the master terminal	Prohibit master operation.	Perform it at master terminal.
E101	PLU maintenance file full. Press <#2> to exit	Scanning PLU direct maintenance/batch maintenance file becomes full.	Terminate the maintenance.
E105	PLU file full	Scanning PLU/not found PLU file full	
E106	Item exists in the PLU FILE	The designated item has already existed in the scanning PLU file.	Modify the designated item.
E121	Inline startup error	Network startup error.	
E139	Negative balance is not allowed	Attempt to register <-> or <CPN> when the balance becomes negative.	Enter proper minus/coupon amount.
E140	Wrong menu	This sheet holder is prohibited by PGM.	Set correct sheet holder.
E146	Arrangement file full	Arrangement file is full.	Set the arrangement properly.
E200	Insert CF card	No CF card is set.	Set CF card.
E203	Insufficient memory	Insufficient memory in the CF card.	Use a vacant (formatted) CF card.
E205	File already exist.	Can not write, because designated file has already been in the CF card.	Check the operation and retry.

## When the register does not operate at all

Perform the following check whenever the cash register enter an error condition as soon as you switch it on. The results of this check are required by service personnel, so be sure to perform this check before you contact a CASIO representative for servicing.

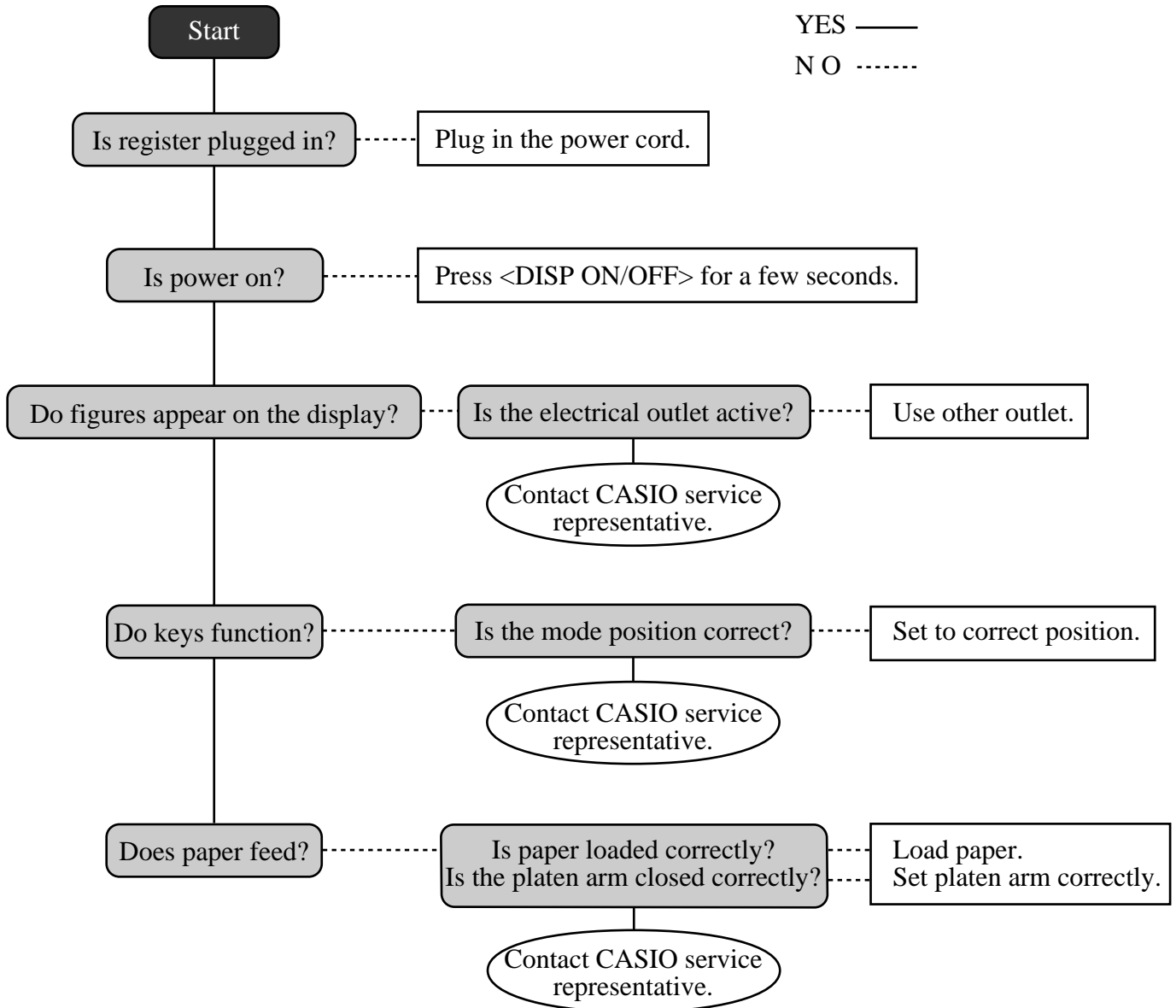

## Clearing a machine lock up

If you make a mistake in operation, the cash register may lock up to avoid damage to programs and preset data. Should it happens, you can use the following procedure to clear the lock up without losing any data.

- 1 Power off the register.
- 2 Insert the PGM key in the mode switch.
- 3 Press down **RECEIPT FEED**, and turn the mode switch to PGM mode.
- 4 The display shows ten Fs, then release **RECEIPT FEED**.
- 5 Press **SUB TOTAL**. The display shows ten Fs and issue a receipt.

### Important!

- If the register does not show ten Fs, never press **SUB TOTAL** and call service representative.

## In case of power failure

If the power supply to the cash register is cut by a power failure or any other reason, simply wait for power to be restored. The details of any on-going transaction as well as all sales data in memory are protected by the memory backup batteries.

- Power failure during a registration  
The subtotal for items registered up to the power failure is retained in memory. You will be able to continue with the registration when power is restored.
- Power failure during printing a read/reset report  
The data already printed before the power failure is retained in memory. You will be able to issue a report when power is restored.
- Power failure during printing of a receipt and the journal  
Printing will resume after power is restored. A line that was being printed when the power failure occurred is printed in full.
- Other  
The power failure symbol is printed and any item that was being printed when the power failure occurred is reprinted in full.

The memory protection battery is constantly charging and discharging as you switch the cash register on and off during normal operations. This causes the capacity of the battery to decrease after approximately five years of use.

### Important !

- Remember a weak battery has the potential of losing valuable transaction data.
- A label on the back of the cash register shows the normal service period of the battery installed in your cash register.
- Have the battery replaced by your dealer within the period noted on this label.

## To replace journal paper

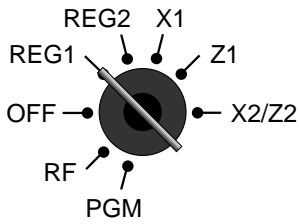

### Step 1

Turn the mode switch to REG1 position.



### Step 2

Remove the printer cover. (If the cover is locked, unlock by using the printer cover key before this step.)



### Step 6

Slide the printed journal from the take-up reel.



### Step 3

Press **JOURNAL FEED** to feed about 20 cm of paper.



### Step 7

Open the platen arm.



### Step 4

Cut the journal paper at the point where nothing is printed.



### Step 8

Remove the old paper roll from the cash register.



### Step 5

Remove the journal take-up reel from its holder.

### Step 9

Load new paper. Go to the step 3 described on page 14 of this manual.

## To replace receipt paper

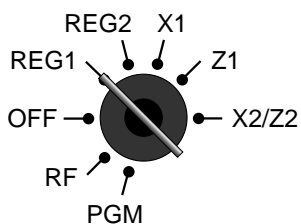

### Step 1

Turn the mode switch to REG1 position.



### Step 2

Remove the printer cover.  
(If the cover is locked, unlock by using the printer cover key before this step.)



### Step 3

Open the platen arm.



### Step 4

Remove the old paper roll from the cash register.

### Step 5

Load new paper.  
Go to the step 3 described on page 13 of this manual.

## Options

Wetproof cover:	WT-78/79 (For TE-4000F) WT-82 (For TE-4500F)	Slip printer:	SP-1300
Memory chip:	RK-3	Cable:	PRT-CB-8C
Hand held scanner:	HHS-15	Power supply:	31AD-U or 31AD-E
Inline board :	I/O-PB17	External printer:	UP-350, UP-250
	(Except for the U.S. and Canada)	Cable:	PRT-CB-8A or PRT-CB-8B
		Power supply:	PS-180 and AC-170

Consult with your CASIO dealer for details.

# Specifications

## Input method

Entry: 10-key system, buffer memory 8 keys (2-key roll over)  
 Department: Full key system

## Display

Main: Amount 10 digits (zero suppression); No. of repeats, total, change, receipt on/off, transaction indicator  
 Descriptor 16 digits × 2 lines; item descriptor, No. of items, mode, clerk name  
 Customer: Amount 10 digits (zero suppression): total, change indicator

## Printer

Receipt: Thermal alpha-numeric system 29 digits, receipt on/off switch (key)  
 Store name or slogan is printed automatically  
 Graphic logo: 20 (H) × 53 (W) mm  
 Journal: Thermal alpha-numeric system 29 digits  
 Automatic take up roll winding  
 Journal paper near end sensor (option)  
 Paper roll: 58 (W) × 83 (D) mm  
 Paper feed: Separate for receipt and journal  
 Print speed: About 20 l/s

## Listing capacity

Amount: 99999999  
 Quantity: 9999.999  
 Tendered amount: 9999999999  
 Percent: 99.99  
 Tax rate: 9999.9999  
 Numbers: 9999999999999999

## Chronological data

Date print: Automatic date printout on receipt or journal, automatic calendar  
 Time print: Automatic time printout on receipt or journal, 24-hour system/12-hour system

## Alarm

Key catch tone, error alarm, sentinel alarm

## Memory protection battery

48-hour full charge protects memories for approximately 90 days.  
 Battery should be replaced every five years.

## Power supply/power consumption

See the rating plate.

## Operation temperature

0°C ~ 40°C (32°F ~ 104°F)

## Humidity

10 ~ 90%

## Dimensions and weight

215mm (H) × 410mm (W) × 491mm (D) / 8kg ...without drawer  
 (8 15/32" (H) × 16 5/32" (W) × 19 11/32" (D) / 17lbs. 10oz.) ...without drawer

Totalizers	Contents						
	Category	No. of totalizers	Amount (10 digits)	No. of items (6 integer/3 decimal)	Count (4 digits)	No. of customers (6 digits)	Periodic totalizers
Department	Up to 10	✓	✓				✓
PLU	Up to 216	✓	✓				
Clerk	15	✓	✓	✓	✓	✓	✓
Hourly sales	24	✓				✓	
Monthly sales	31	✓	✓			✓	
Transaction	Variable with program						✓
Non ressettable grand total	3	✓ (16 digits)					
Reset counter	12/15				✓		
Consecutive No.	1				✓ (6 digits)		

\* Specifications and design are subject to change without notice.



## A

add check 26, 84  
adding to a check 81  
addition (+) 58  
alphabet key 99  
arrangement 26, 65  
assigning a clerk 32

## B

backlight color control 20  
backspace key 99  
bill copy 26, 90  
bottle link 64  
bottle return 26, 64  
bottom message 30, 95

## C

cancel 23, 24, 26, 53  
CAP key 99  
cash/amount tendered 23, 25, 45  
change 34  
character code 100  
character code fixed key 99  
character enter key 99  
character fixed key 99  
character keyboard 99  
charge 23, 25  
check 23, 25, 45  
check endorsement 26  
check print 26  
check tracking 80  
clearing a machine lock up 117  
clerk button 19, 32  
clerk interrupt 56  
clerk key 32  
clerk key/button/lock 19, 32  
clerk lock 32  
clerk name 32, 95  
clerk number 22, 24, 94  
clerk read/reset report 103  
clerk secret number key 19, 32  
clerk transfer 26, 86  
closing a check 82  
commercial message 30, 95  
commission rate 94  
condiment 88  
consecutive No. 30  
contrast control 20  
correction 51  
coupon 26, 61  
coupon II (2) 26, 61  
credit 23, 25, 45  
cube 26  
currency exchange 22, 24, 66  
cursor key 99  
customer display 20  
customer number 26

## D

daily sales read/reset report 104  
daily sales reset report 54  
Dallas key 16, 17  
date display 33  
date set 15  
declaration 26  
department 23, 25, 34  
deposit 26, 89  
descriptor 95  
discount (%-) 22, 24, 42  
display 20  
double size letter key 99  
drawer 19

## E

eat-in 26  
EBT (electronic benefits transfer) 26, 75  
editing character 101  
entering characters 99  
error code 114  
error correction 23, 24, 51  
Euro 25, 46

## F

financial read report 103  
flat PLU 23, 24, 34  
food stamp 68  
food stamp shift 26, 68  
food stamp subtotal 26, 68  
food stamp tender 26, 68

## G

group read/reset report 107  
guest receipt 82

## H

high amount limitation 36  
hourly sales read/reset report 106

## I

Illinois rule 71  
indicator 21  
individual clerk read/reset report 103  
individual department, PLU/flat-PLU read report 102  
item counter 21, 30

## J

journal 14, 30  
journal paper replacement 118  
journal skip 30

## K

Ketten Bon 26  
keyboard 16, 17  
keyboard (TE-4000F) 22  
keyboard (TE-4500F) 24

## L

loan 22, 24, 50  
locking platen 13, 14  
logo message 30, 95

## M

machine No. 30  
main display 16, 17, 20  
manual tax 26  
media change 26, 50  
menu shift 26  
merchandise subtotal 26, 41  
message 30, 95  
minus 22, 24, 43  
mixed tender 45  
mode key 17  
mode keys 16, 17  
mode switch 18  
money declaration 103, 105  
monthly sales read/reset report 107  
multiplication 23, 25, 35, 39  
multiplication/for 23, 25, 35, 40

## N

new balance 26, 81  
new check 26, 80  
new/old check 26, 80  
no sale 23, 25, 26  
non add 23, 25, 26  
normal receipt 26  
not found PLU 93  
number of customers 77

## O

OBR (optical barcode reader) 26  
old check 26, 80  
one touch NLU 26, 93  
open 22, 24  
open 2 (release compulsion) 26, 78  
open check 27  
open PLU 40  
opening a check 81  
operator number 27, 86  
operator X/Z 27  
option 119

## P

paid out 23, 49  
paper feed 22, 24  
paper installation 12  
paper loading 12  
periodic sales 108  
pick up 22, 24, 50  
platen 12  
platen arm 12, 16, 17  
PLU 38  
PLU/flat-PLU read/reset report 106  
plus 27  
pop-up display 16, 17  
post receipt 22, 24  
power failure 117  
premium (%+) 27, 59  
preparation 88  
preset price 37  
preset tax status 37  
preset tender 63  
previous balance 27  
previous balance subtotal 27  
previous item void 92  
price 27, 40  
price change 27  
price inquiry 27  
price reductions (red price) 87  
price shift 27  
printer 12, 16, 17  
printer cover 16, 17  
printer cover key 16, 17  
printing slip 79  
program end key 99

## R

rate tax 27  
read report 102  
recall 27  
receipt 13, 30  
receipt on/off 22, 24  
receipt on/off switch / key 16  
receipt paper replacement 119  
received on account 23, 25, 49  
red price 27, 87  
reduction 43  
refund 22, 24, 48  
remove/replace the sheet holder 28  
repeat 21, 34, 39  
reset report 54, 102  
return 48  
review 27, 85, 92  
RF mode 48  
roll paper 16, 17  
roll paper installation 12

## S

- scale 27
- scanning PLU 93
- second unit price 62
- separate check 27, 85
- set menu 65
- shift key 99
- sign off 32
- sign on 32
- single item 34, 39, 57
- slip 79
- slip back feed/release 27, 79
- slip feed/release 27, 79
- slip print 27, 79
- space key 99
- split sales of packaged item 35, 40
- square 27
- stock check 56
- stock inquiry 27, 91
- store 27
- subtotal 23

## T

- table number 27, 81
- table transfer 27, 86
- take-up reel 16, 17
- takeout 27
- tare 27
- tax exempt 27
- tax shift 22, 24, 41
- taxable amount subtotal 27
- taxable status 41
- text print 27
- text recall 27, 78
- tilt LCD 20
- time display 33
- time set 15
- tip 27, 76
- trainee status 94
- tray total 27, 60

## U

- unit price inquiry 91
- unit weight 27

## V

- validation 27
- VAT 22, 24, 89
- void 27

## W

- wetproof cover 17, 119

**CASIO®**

**CASIO COMPUTER CO., LTD.**  
6-2, Hon-machi 1-chome  
Shibuya-ku, Tokyo 151-8543, Japan

TE-4000\*E

MO0305-A Printed in Malaysia

Printed on recycled paper.