

ELECTRONIC CASH REGISTER

TE-8000F

TE-8500F

User's Manual



TE-8000F



TE-8500F

Introduction

Setting Up

Getting Started

Paper Installation

Set Date/time

Introducing the Terminal

Display/Keyboard

Sheet Holder

Basic Operations & Setups

Registrations

Programs

Advanced Operations

Useful Features

Reports

Troubleshooting

Error Code Table

User Maintenance

Paper Replacement

Eu

Di

U.K.

CI

Canada

CASIO®

Introduction

Congratulations on your selection of a CASIO TE-8000F/8500F series electronic cash register. This ECR is the product of the world's most advanced electronic technology, for outstanding versatility and reliability. Simplified operation is made possible by a specially designed keyboard layout and a wide selection of automated, programmable functions. A specially designed keyboard layout and a bright, easy-to-read color display help to take the fatigue out of long hours operation.



Casio Electronics Co., Ltd.
Unit 6, 1000 North Circular Road
London NW2 7JD, U.K.

WARNING: This is a Class A product. In a domestic environment this product may cause radio interference in which case the user may be required to take adequate measures.

Please keep all information for future reference.

GUIDELINES LAID DOWN BY FCC RULES FOR USE OF THE UNIT IN THE U.S.A. (Not applicable to other areas)

WARNING: This equipment has been tested and found to comply with the limits for a Class A digital device, pursuant to Part 15 of the FCC Rules. These limits are designed to provide reasonable protection against harmful interference when the equipment is operated in a commercial environment. This equipment generates, uses, and can radiate radio frequency energy and, if not installed and used in accordance with the instruction manual, may cause harmful interference to radio communications. Operation of this equipment in a residential area is likely to cause harmful interference in which case the user will be required to correct the interference at his own expense.

FCC WARNING: Changes or modifications not expressly approved by the party responsible for compliance could void the user's authority to operate the equipment.

Apparaten skall anslutas till jordat nätuttag.

The main plug on this equipment must be used to disconnect mains power. Please ensure that the socket outlet is installed near the equipment and shall be easily accessible.

Safety Precautions

- To use this product safely and correctly, read this manual thoroughly and operate as instructed.
After reading this guide, keep it close at hand for easy reference.
Please keep all informations for future reference.
- Always observe the warnings and cautions indicated on the product.

About the icons

In this guide various icons are used to highlight safe operation of this product and to prevent injury to the operator and other personnel and also to prevent damage to property and this product. The icons and definitions are given below.



Indicates that there is a risk of severe injury or death if used incorrectly.



Indicates that injury or damage may result if used incorrectly.

Icon examples

To bring attention to risks and possible damage, the following types of icons are used.



The \triangle symbol indicates that it includes some symbol for attracting attention (including warning). In this triangle the actual type of precautions to be taken (electric shock, in this case) is indicated.



The \otimes symbol indicates a prohibited action. In this symbol the actual type of prohibited actions (disassembly, in this case) will be indicated.



The \bullet symbol indicates a restriction. In this symbol the type of actual restriction (removal of the power plug from an outlet, in this case) is indicated.

Warning!

Handling the register



Should the register malfunction, start to emit smoke or a strange odor, or otherwise behave abnormally, immediately shut down the power and unplug the AC plug from the power outlet. Continued use creates the danger of fire and electric shock.

- Contact CASIO service representative.



Do not place containers of liquids near the register and do not allow any foreign matter to get into it. Should water or other foreign matter get into the register, immediately shut down the power and unplug the AC plug from the power outlet. Continued use creates the danger of shorting, fire and electric shock.

- Contact CASIO service representative.



Should you drop the register and damage it, immediately shut down the power and unplug the AC plug from the power outlet. Continued use creates the danger of shorting, fire and electric shock.

- Attempting to repair the register yourself is extremely dangerous. Contact CASIO service representative.
-

⚠ Warning!



Never try to take the register apart or modify it in any way. High-voltage components inside the register create the danger of fire and electric shock.

- Contact CASIO service representative for all repair and maintenance.

Power plug and AC outlet



Use only a proper AC electric outlet (100V~240V) . Use of an outlet with a different voltage from the rating creates the danger of malfunction, fire, and electric shock. Overloading an electric outlet creates the danger of overheating and fire.



Make sure the power plug is inserted as far as it will go. Loose plugs create the danger of electric shock, overheating, and fire.

- Do not use the register if the plug is damaged. Never connect to a power outlet that is loose.



Use a dry cloth to periodically wipe off any dust built up on the prongs of the plug. Humidity can cause poor insulation and create the danger of electric shock and fire if dust stays on the prongs.



Do not allow the power cord or plug to become damaged, and never try to modify them in any way. Continued use of a damaged power cord can cause deterioration of the insulation, exposure of internal wiring, and shorting, which creates the danger of electric shock and fire.

- Contact CASIO service representative whenever the power cord or plug requires repair or maintenance.

⚠ Caution!



Do not place the register on an unstable or uneven surface. Doing so can cause the register — especially when the drawer is open — to fall, creating the danger of malfunction, fire, and electric shock.



Do not place the register in the following areas.

- Areas where the register will be subject to large amounts of humidity or dust, or directly exposed to hot or cold air.
- Areas exposed to direct sunlight, in a close motor vehicle, or any other area subject to very high temperatures.

The above conditions can cause malfunction, which creates the danger of fire.



Do not overlay bend the power cord, do not allow it to be caught between desks or other furniture, and never place heavy objects on top of the power cord. Doing so can cause shorting or breaking of the power cord, creating the danger of fire and electric shock.



Be sure to grasp the plug when unplugging the power cord from the wall outlet. Pulling on the cord can damage it, break the wiring, or cause short, creating the danger of fire and electric shock.



Never touch the plug while your hands are wet. Doing so creates the danger of electric shock. Pulling on the cord can damage it, break the wiring, or cause short, creating the danger of fire and electric shock.

Never touch the printer head and the platen.

Introduction & Contents

Introduction & Contents	6
Getting Started	10
Remove the cash register from its box.	10
Remove the tape holding parts of the cash register in place.	10
Remove the cash drawer from its box.	10
Connect the drawer.	10
Mount the cash register.	11
Plug the cash register into a wall outlet.	11
Install receipt/journal paper.	12
Set the date.	14
Set the time.	15
Introducing TE-8000F/8500F	16
General guide	16
Display	20
Keyboard (TE-8000F)	22
Keyboard (TE-8500F)	23
Allocatable functions	24
How to remove/replace the sheet holder (TE-8000F only)	26
How to install a menu sheet in the sheet holder (TE-8000F only)	27
Basic Operations and Setups.....	28
How to read the printouts	28
How to use your cash register	29
Assigning a clerk	30
Clerk button	30
Dallas key	30
Clerk number key	30
Displaying the time and date	31
To display and clear the date/time	31
Preparing coins for change	31
Preparing and using flat-PLU keys	32
Registering flat-PLU keys	32
Programming to flat-PLU	33
Flat-PLU unit price programming procedure	33
Flat-PLU department link/tax status/listing capacity programming procedure	34
Registering flat-PLU keys by programming data	35
Preset price	35
Preset tax status	35
Locking out high amount limitation	35
Preparing and using discounts/reductions	36
Programming discount rate and reduction amount	36
Registering discounts	37
Discount for items and subtotals	37
Registering reductions	38
Reduction for items	38
Reduction for subtotal	38
Registering credit and check payments.....	39
Check	39
Credit	39

Mixed tender (cash, credit and check)	39
Registering both the Euro and local currency	40
Registering returned goods in the REG mode	42
Registering returned goods in the REF mode	43
Normal refund transaction	43
Reduction of amounts paid on refund	43
Registering money received on account	44
Registering money paid out	44
Making corrections in a registration	45
To correct an item you input but not yet registered	45
To correct an item you input and registered	46
To correct the item you registered previously in this receipt	47
To cancel all items in a transaction	47
No sale registration	47
Printing the daily sales reset report	48
Procedure	48
Printout	49
Advanced Operations	50
Post-finalization receipt	50
Inputting the number of customers	51
Clerk interrupt function	52
Printing slip	53
Printing slips	53
To perform auto batch printing 1	53
To perform auto batch printing 2	54
About the maximum number of slip lines	54
Check tracking systems	54
Check tracking system	54
Opening a check	55
Adding to a check	55
Issuing a guest receipt	56
Closing a check memory	56
New/old check key operation	57
Add check	58
Separate check	59
Clerk transfer	60
Table transfer	60
Condiment/preparation PLUs	61
Text recall	61
Deposit registrations	62
Deposit from customer	62
Deposit from customer during sales transaction	62
List-# registrations	62
Bill copy	63
Tray total	64
Multiple item totalling function	64

Introduction & Contents

Set menu	65
Tips	65
Stock check	66
Actual stock quantity inquiry	66
Single item cash sales	67
Addition	68
Addition (plus)	68
Premium (%+)	68
Coupon transactions	69
Coupon registration using <COUPON> (coupon key)	69
Coupon registration using <CPN2> (coupon 2 key)	69
Registering the second unit price	70
Preset tender amount	72
Arrangement key registrations	73
Currency exchange function	74
Registering foreign currency	74
Full amount tender in a foreign currency	74
Partial tender in a foreign currency	75
Temporarily releasing compulsion	76
VAT breakdown printing	77
Registering loan amounts	78
Registering pick up amounts	78
Changing media in drawer	78
Scanning PLU	79
Item registration	79
Unit price inquiry	79
Programming to clerk	80
Programming procedure	80
Programming descriptors and messages	81
Programming item descriptor (flat-PLU) procedure	81
Programming function key character procedure	82
Programming receipt/slip message procedure	83
Entering characters	84
Using character keyboard	84
Entering characters by code	85
Character code list	85
Editing characters	86
Correcting a character just entered	86
Correcting and adding/deleting an item descriptor already set	86
Printing read/reset reports	87
The tree of X/Z menu window	87
To print the individual key (department, subdepartment, PLU/flat-PLU, function) read report	88
Procedure	88
Report	88

To print the financial read report	89
Procedure	89
Report	89
To print the individual clerk read/reset report	90
Procedure	90
Report	90
To print the daily sales read/reset report	91
To print the periodic 1/2 sales read/reset reports	91
Procedure	91
Report	91
To print the PLU read/reset report	92
Procedure	92
Report	92
To print the hourly sales read/reset report	93
Procedure	93
Report	93
To print the monthly sales read/reset report	94
Procedure	94
Report	94
Reading the cash register's program	95
The tree of P6 (program read) menu window	95
Procedure	96
Report example	96
Unit price and quantity	96
Item descriptor	97
Character and Message	98
Clerk	98
Key feature	98
Troubleshooting	100
When an error occurs	100
When the register does not operate at all	103
In case of power failure	104
User Maintenance and Options	105
To replace journal paper	105
To replace receipt paper	106
Options	106
Specifications	107
Index	108

Getting Started

This section outlines how to unpack the cash register and get it ready to operate. You should read this part of the manual even if you have used a cash register before. The following is the basic set up procedure, along with page references where you should look for more details.

1. Remove the cash register from its box.

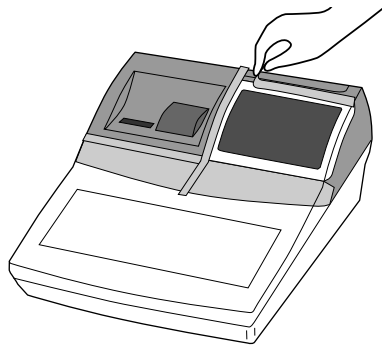
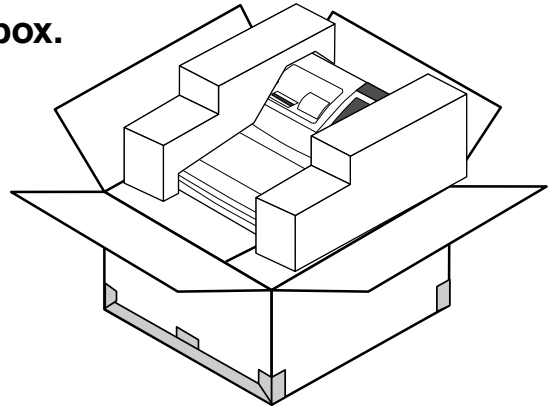

2. Remove the tape holding parts of the cash register in place.

3. Remove the cash drawer from its box.

The cash register and cash drawer are packed separately.

4. Connect the drawer.

1. Connect drawer connector (three color lead on drawer) to the cash register.
2. Connect frame drawer connector (green lead on drawer) to the cash register.

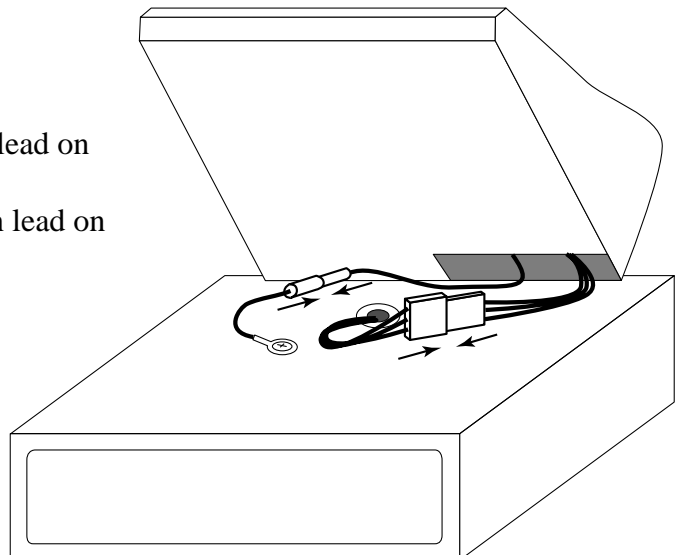

5. Mount the cash register.

1. Screw in 2 fixing screws bottom side of the register.
2. Stick rubber plate on the each corner of the bottom side of the register.
3. Mount the cash register on the top of the drawer, ensuring that the feet on the bottom of the cash register go into the holes on the drawer.

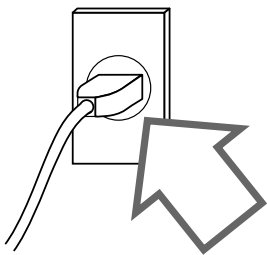
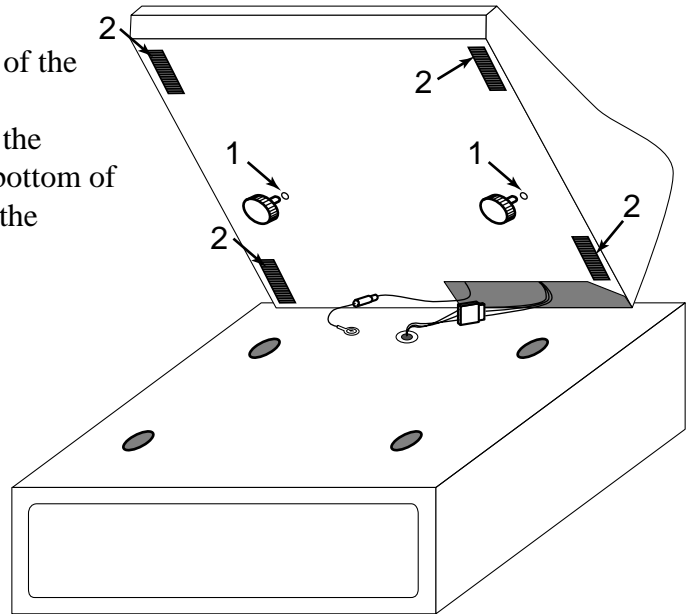

6. Plug the cash register into a wall outlet.

Be sure to check the sticker on the side of the cash register to make sure that its voltage matches that of the power supply in your area. The printer will operate for a few seconds. Please do not pass the power cable under the drawer.

7. Install receipt/journal paper.

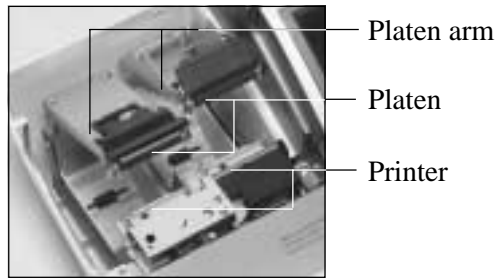

Important!

Take away the head protection sheet from the printer and close the platen arm.

Caution! (in handling the thermal paper)

- Never touch the printer head and the platen.
- Unpack the thermal paper just before your use.
- Avoid heat/direct sunlight.
- Avoid dusty and humid places for storage.
- Do not scratch the paper.
- Do not keep the printed paper under the following circumstances:
High humidity and temperature/direct sunlight/contact with glue, thinner or a rubber eraser.

To install receipt paper



Step 1

Remove the printer cover.
(If the cover is locked, unlock by using the printer cover key before this step.)



Step 4

Put the leading end of the paper over the printer.



Step 2

Open the platen arm.

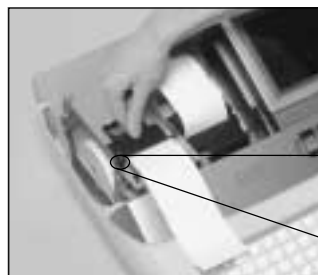

Step 5

Close the platen arm slowly until it locks steadily.



Step 3

Ensuring the paper is being fed from the bottom of the roll, lower the roll into the space behind the printer.

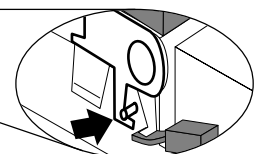

Locking platen



Complete

Close the printer cover, passing the leading end of the paper through the cutter slot.

To install journal paper



Step 1

Remove the printer cover.
(If the cover is locked, unlock by using the printer cover key before this step.)



Step 2

Open the platen arm.



Step 3

Ensuring the paper is being fed from the bottom of the roll, lower the roll into the space behind the printer.



Step 4

Put the leading end of the paper over the printer.

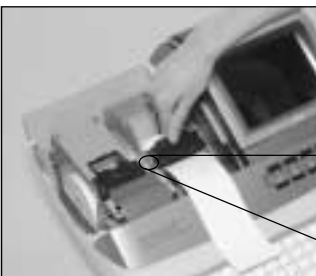

Step 5

Close the platen arm slowly until it locks steadily.

Locking platen



Step 6

Slide the leading end of the paper into the groove on the spindle of the take-up reel and wind it onto the reel two or three turns.



Step 7

Place the take-up reel into place behind the printer, above the roll paper.



Step 8

Press the **JOURNAL FEED** key to take up any slack in the paper.

During machine installation, press the **JOURNAL FEED** key after power on.



Complete

Close the printer cover.

8. Set the date.

1. Turn on the register.

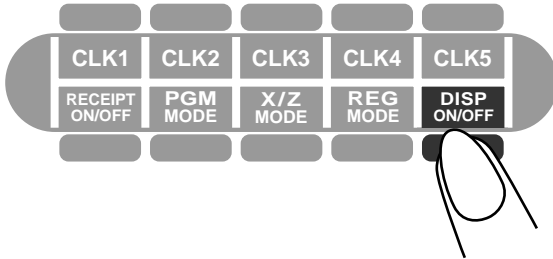

2. Sign on a clerk.

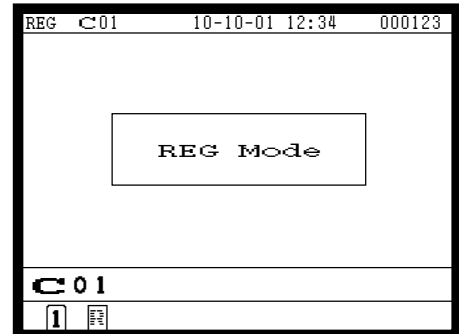
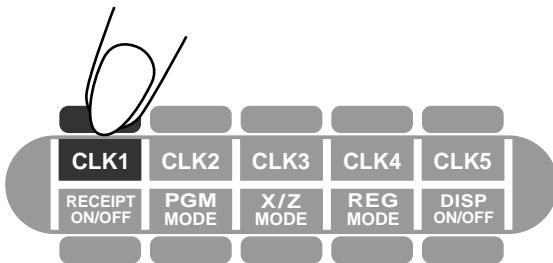

3. Press the <PGM MODE> key.

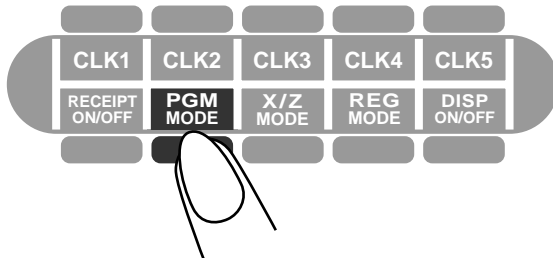

4. Enter the current date in six digits (year, month, day order) and press the key.

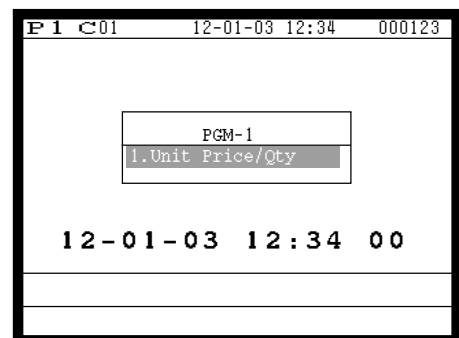

9. Set the time.

1. Turn on the register.

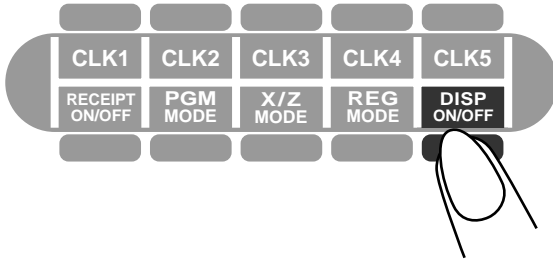

2. Sign on a clerk.

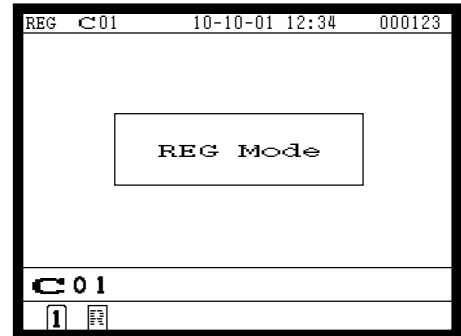
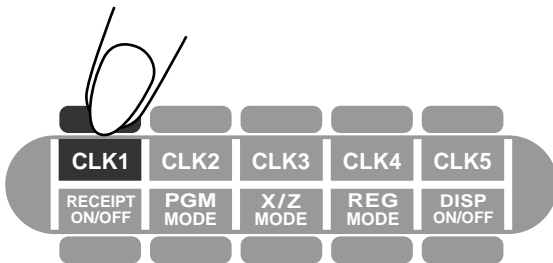

3. Press the <PGM MODE> key.

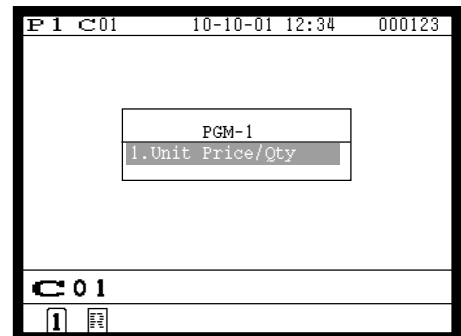
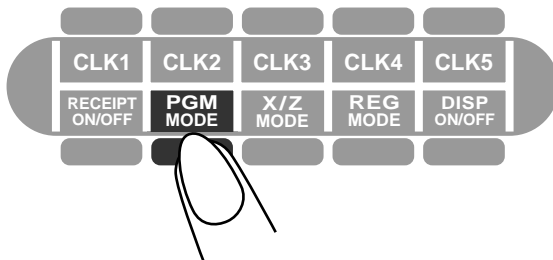

4. Enter the current time in four digits (hour, minute order) and press the key.

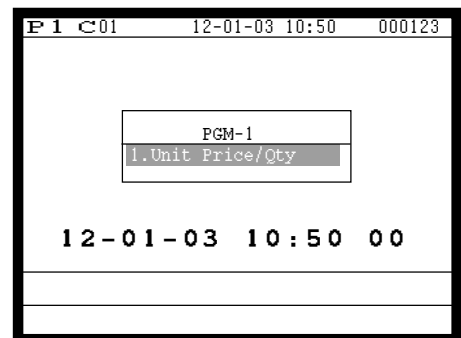

Introducing TE-8000F/8500F

General guide

This part of the manual introduces you to the cash register and provides a general explanation of its various parts.

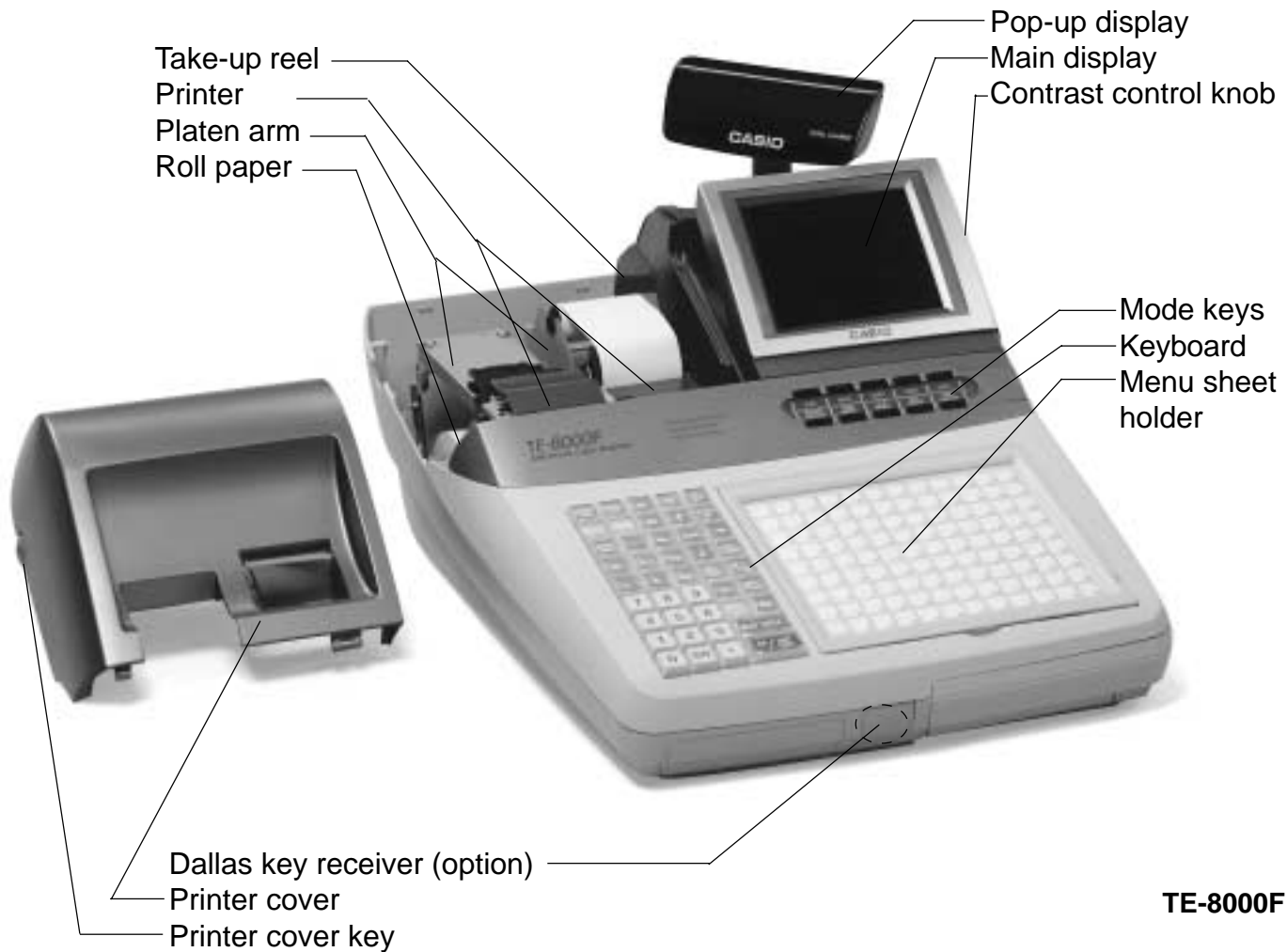

Contrast control knob

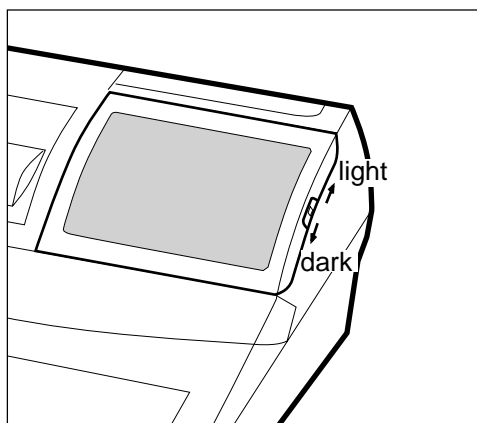

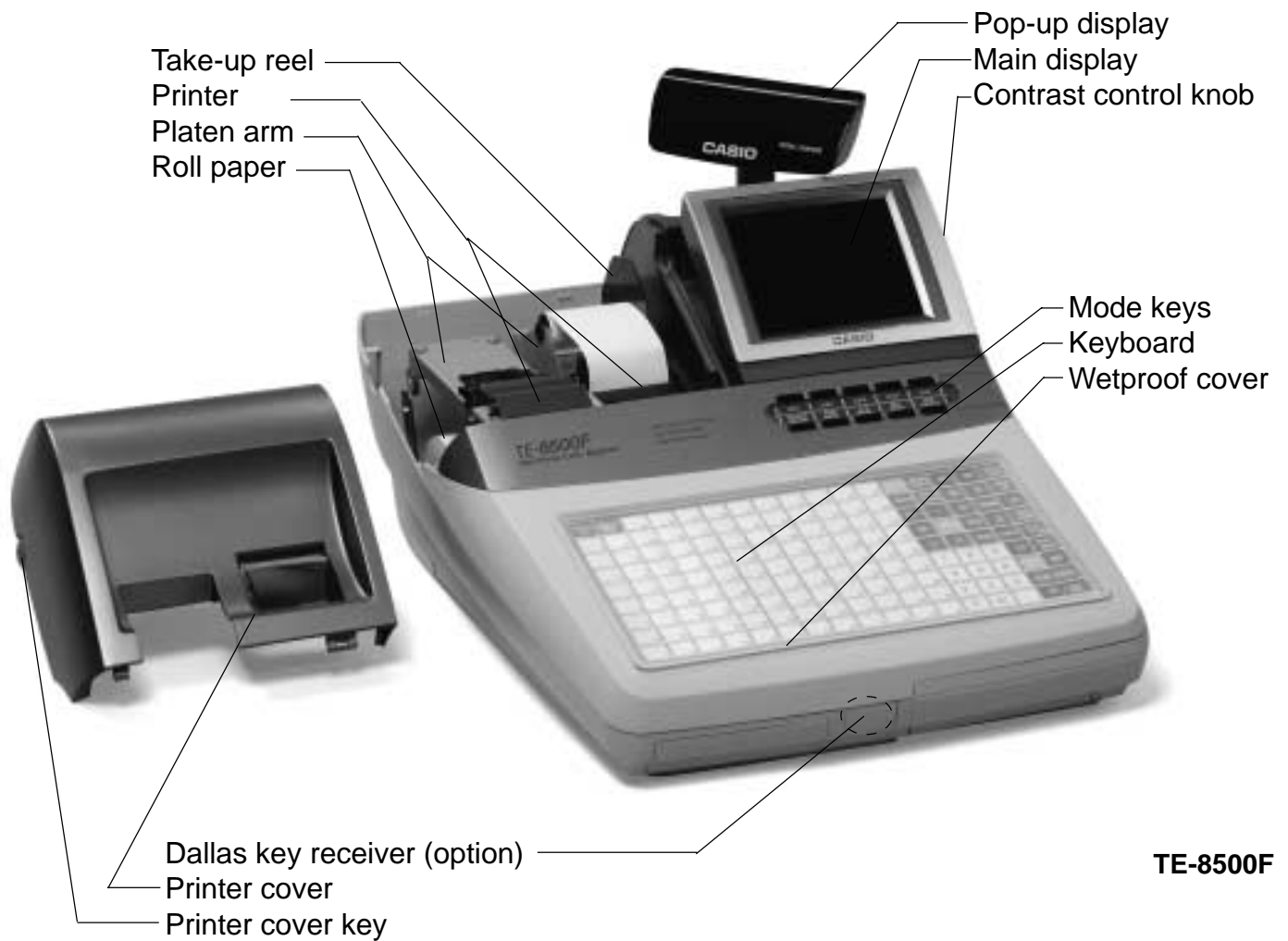

Introducing TE-8000F/8500F

TE-8500F

Tilt the LCD

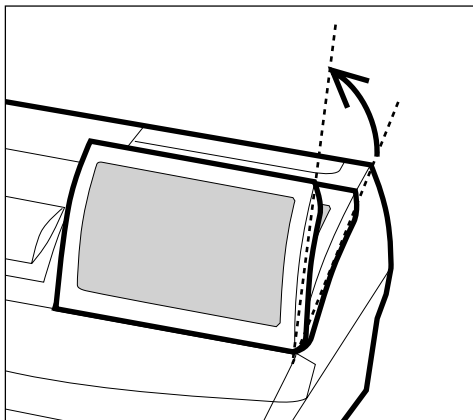

Introducing TE-8000F/8500F

Mode keys

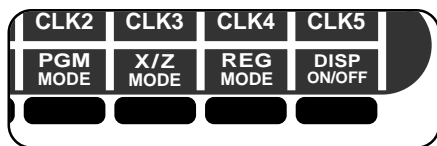

Use the mode keys to change the mode and select the mode you want to use.

Mode key	Mode key name	Description
DISP ON/OFF	Display on/off key	This key is used for turning on/off the cash register.
REG MODE	Register mode key	This key is used for selecting the REG (register), REF (refund) and REG– (register minus) modes.
X/Z MODE	X/Z mode key	This key is used for selecting the X/Z (read/reset), MGR (manager), Inline X/Z (collection/consolidation), Auto PGM (program upload/download), CF (CF card) modes.
PGM MODE	Program mode key	This key is used for selecting the PGM1, PGM2, PGM3, PGM4, PGM5, PGM6 modes.

Receipt on/off key

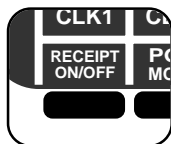

Press this key twice to change the setting “Receipt issue”/“No receipt issue” in REG/REF/REG– modes.

In other modes, the receipts and reports are printed regardless this key’s settings.

A post-finalization receipt can still be issued after finalization when this key is set to off. The cash register can also be programmed to issue a post-receipt even when the key is set to on.

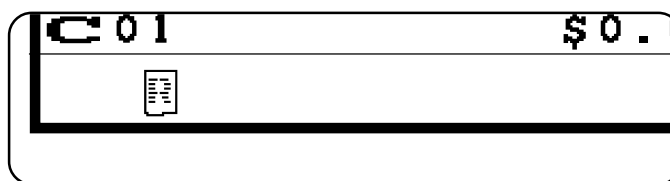

Receipt issue:  is displayed on the bottom line of the display.

Clerk button/Dallas key

In Germany, you can assign clerks by using Dallas key (Dallas key receiver is equipped) or by using clerk secret number.

In other areas, you can assign clerks by using clerk button or by clerk secret number.

The method you are assigning clerk depends on the programming of your cash register.

Clerk button

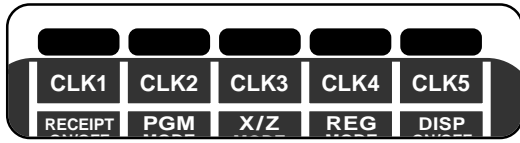

You can assign the clerk or cashier using the five buttons located below the display panel.

Dallas key

You can assign the clerk or cashier touching with a Dallas key on the receiver.

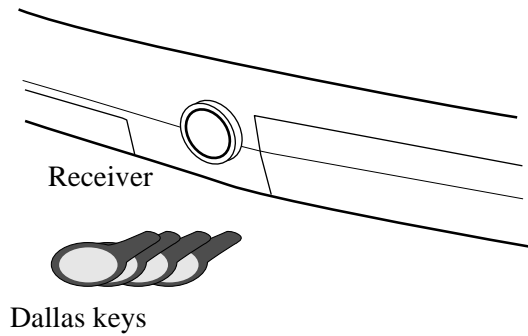

Drawer

The drawer opens automatically whenever you finalize a registration and you issue a read or reset report.

Drawer lock (for medium size drawer)

Use the drawer key to lock and unlock the drawer.

Drawer open key (for large size drawer)

Use the drawer open key to open the drawer.

When the cash drawer does not open! (for medium size drawer only)

In case of power failure or the machine is in malfunction, the cash drawer does not open automatically. Even in these cases, you can open the cash drawer by pulling drawer release lever (see below).

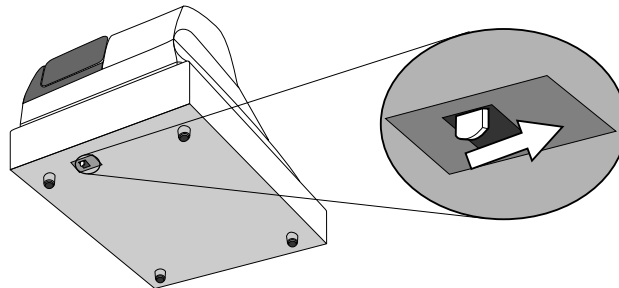

Important!

The drawer will not open, if it is locked with a drawer lock key.

Introducing TE-8000F/8500F

Display

Main display

The main display shows a transaction list with the following items and amounts:

Mode	Clerk	Date	Time	Consecutive number
RÉG	C01	01-01-01	12:34	001234
1	Spagetti		·20.00 T1	
1	Spagetti		·20.00 T1	
	7.5%			
	%-		-1.75 T1	
1	Coffee		·8.00	
1	Hamburger		·2.00 T1	
	15%			
	%-		-0.30 T1	
1	Milk		·2.00	
2	Apple Juice		·5.00	
1	Coffee		·8.00	
Spagetti			·20.00	
[Icons]			·76.50	

Labels in the image: Mode, Clerk, Date, Time, Consecutive number, Scroll area, Status Icons, Items sold, Amount (total/change).

- Communication: [Icon]
- Menu sheet No.: [1] ~ [8]
- 2nd unit price: [2nd] or shift PLU level: 2 ~ 8
- Master/BM error: [Icon]
- Cut off Master or BM: [Icon]
- Receipt on: [Icon]
- Character shift:
 - Capital/double size: [A]
 - Capital/standard size: [A]
 - Small/double size: [a]
 - Small/standard size: [a]

Pop-up display



In the operation examples contained in this manual, the display samples are not actual size. Also, all samples are just images.

Display example

Normal registration

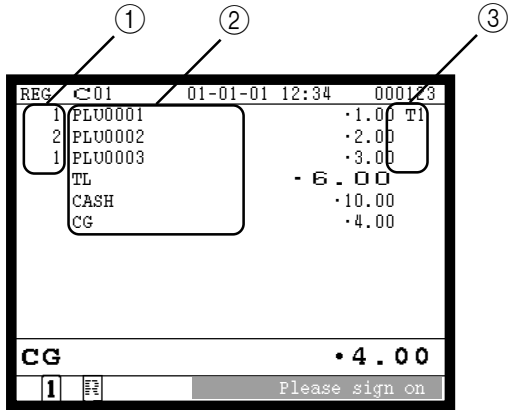

① **Registered item quantity**

This part of the display shows item count of each item.

② **Item/key descriptor**

When you register a department/PLU/scanning PLU or transaction key, the item descriptor or key descriptor appears here.

③ **Tax status**

When you register a taxable item, the corresponding tax status appears here by programming.

Check tracking registration

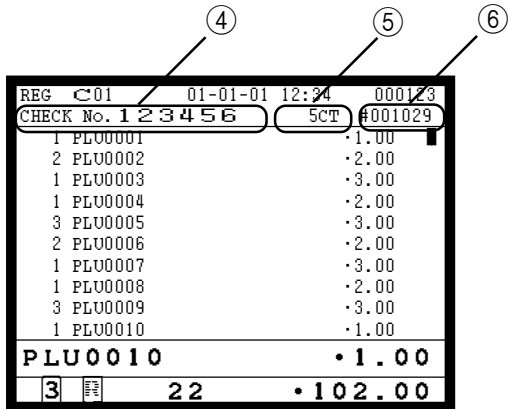

④ **Check number**

When you enter a check number, it appears here.

⑤ **Number of customer**

When you enter number of customers, it appears here.

⑥ **Table number**

When you enter a table number, it appears here.

Registration by sub window

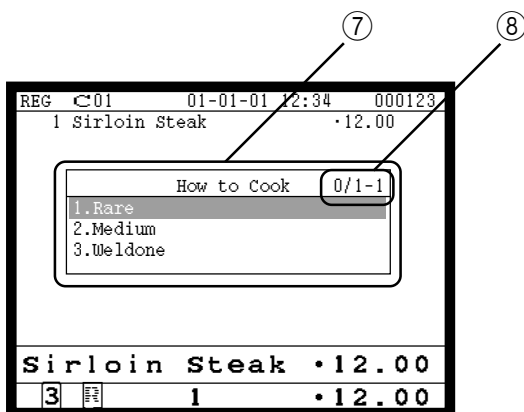

⑦ **Sub window**

It automatically opens to select options.

⑧ **Staydown counters**

It shows “registered”, “minimum” and “maximum” numbers.

Introducing TE-8000F/8500F

Keyboard (TE-8000F)

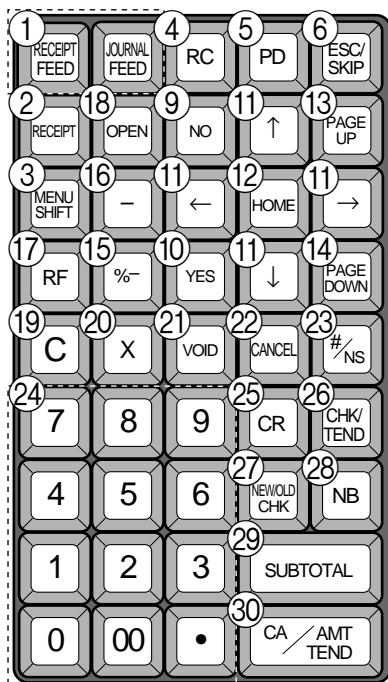

31

9	18	27	36	45	54	63	72	81	90	99	108
8	17	26	35	44	53	62	71	80	89	98	107
7	16	25	34	43	52	61	70	79	88	97	106
6	15	24	33	42	51	60	69	78	87	96	105
5	14	23	32	41	50	59	68	77	86	95	104
4	13	22	31	40	49	58	67	76	85	94	103
3	12	21	30	39	48	57	66	75	84	93	102
2	11	20	29	38	47	56	65	74	83	92	101
1	10	19	28	37	46	55	64	73	82	91	100

• Register Mode

- ① **Paper feed key** ,
Hold this key down to feed paper from the printer.
- ② **Post receipt key**
Use this key to produce a post-finalization receipt.
- ③ **Menu shift key**
Use this key to shift Flat-PLU key to n-th (1 ~ 8) menu.
- ④ **Received on account key**
Use this key following a numeric entry to register money received for non-sale transactions.
- ⑤ **Euro/Paid out key**
Euro key: Use this key to convert the main currency to the sub currency (the euro/the local money), when registering the subtotal amount. This key is also used for specifying sub currency while entering an amount of payment.
Paid out key: Use this key following a numeric entry to register money paid out from the drawer.
- ⑥ **ESC/SKIP key**
Use this key to terminate a program sequence, X/Z sequence, and return the primary status. This key is also used to terminate a report being issued in PGM, X, and Z mode.
- ⑦ **Customer number key**
Use this key to register the number of customers.
- ⑧ **Table transfer key**
Use this key to transfer the contents of a check to another check.
- ⑨ **No key**
Use this key to cancel the selection and proceeding steps.
- ⑩ **Yes key**
Use this key to consent the selection and proceeding steps.
- ⑪ **Left, right, up, down arrow key**
 , , ,
Use these keys to move the cursor.
- ⑫ **Home position key**
Use this key to return the cursor to the home position.
- ⑬ **Page up key**
Use this key to turn the window forwards.
- ⑭ **Page down key**
Use this key to turn the window backwards.
- ⑮ **Discount key**
Use this key to register discounts.
- ⑯ **Minus key**
Use this key to register subtraction.
- ⑰ **Refund key**
Use this key to input refund amounts and void certain entries.
- ⑱ **Open key**
Use this key to temporarily release a limitation on the number of digits that can be input for a unit price.
- ⑲ **Clear key**
Use this key to clear an entry that has not yet been registered.

Keyboard (TE-8500F)

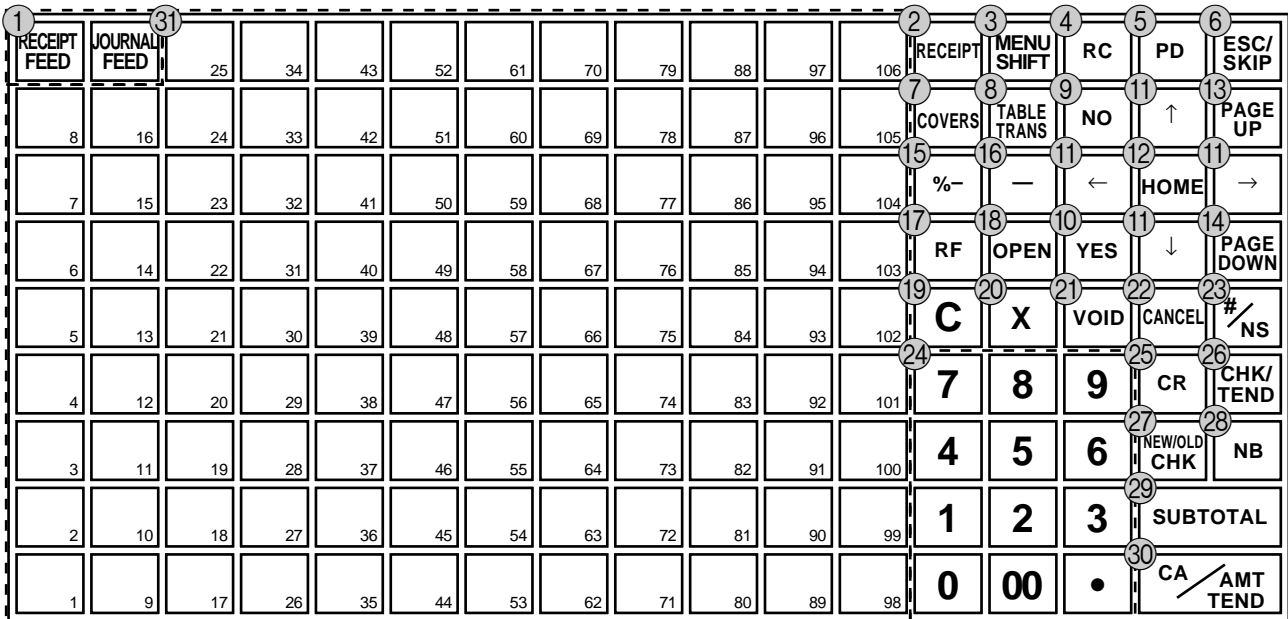

- ⑳ **Multiplication/Date/Time key** X
 Use this key to input a quantity for a multiplication operation. Between transactions, this key displays the current time and date.
- ㉑ **Error correct/Void key** VOID
 Use this key to correct the last registered item, discount, premium, amount tendered etc. This key also invalidates proceeding data registered for PLUs or set menus etc.
- ㉒ **Cancel key** CANCEL
 Use this key to invalidate all proceeding data registered for PLUs, set menus etc. within the transaction. This key must be pressed before the transaction involving the data to be invalidate is finalized. It is also effective even after calculation of subtotal amount.
- ㉓ **Non-add/No sale key** # / NS
 Non-add key: To print reference number (to identify a personal check, credit card, etc.) during a transaction, use this key after some numerical entries.
 No sale key: Use this key to open the drawer without registering anything.
- ㉔ **Ten key pad** 0, 1 ~ 9, 00, .
 Use the keys to input numbers.
- ㉕ **Credit key** CR
 Use this key to register a credit sale.
- ㉖ **Check key** CHK / TEND
 Use this key to register a check tender.
- ㉗ **New/Old check key** NEW / OLD
 Use this key in a check tracking system to input check numbers in order to open new checks and to reopen existing checks. When the clerk inputs a check number, the register checks to see if that number already exists in the check tracking memory. If there is no matching number in the memory, a new check is opened under the input number. If the check number matches a number already stored in the memory, that check is reopened for further registration or finalization.
- ㉘ **New balance key** NB
 Use this key to add the current registered total amount to the previous balance to obtain a new balance. When this key is pressed, the total amount of the transaction is calculated. Normally, a receipt is issued.
- ㉙ **Subtotal key** SUB / TOTAL
 Use this key to display and print the current subtotal (includes add-on tax) amount.
- ㉚ **Cash/Amount tendered key** CA / AMT / TEND
 Use this key to register a cash tender.
- ㉛ **Flat-PLU key** 001, 002 ~ 106, 108
 Use these keys to register items to flat-PLUs.

Allocatable functions

You can tailor a keyboard to suit your particular type of business.

Consult your CASIO dealer for detail information.

Add check

Use this key in a check tracking system to combine the details of more than one check into a single check.

Arrangement

Use this key to activate an arrangement program programmed in the arrangement file. Any operation that can be performed from the keyboard, as well as mode, can be programmed in an arrangement program, and can be performed merely by pressing this key. In addition, one numeric entry can be included in an arrangement program. In this case, input the number and press this key. The mode control function of this key can be programmed for all modes except for the OFF mode.

Bill copy

Use this key to issue bill copy.

Break-in/out

Use this key to register the starting/finishing time when employees have a recess.

Charge

Use this key to register a charge sale.

Check endorsement

Use this key to print a preset check endorsement message using the slip printer.

Check print

Use this key to print the check on the slip printer.

Clerk number

Use this key to assign a clerk's secret number.

Clerk transfer

Use this key to transfer opened checks to another clerk.

Clock-in/out

Use this key to register the time when the employees start/finish their job.

Coupon

Use this key for registering coupons.

Coupon 2

Use this key to declare the next item registration as coupon.

Cube

This key provides the same functions as the Square key. In addition, this key also has a cube multiplication function.

Currency exchange

Use this key to convert foreign currency to local currency or vice versa using the exchange rate preset for the key and displays the result.

Use this key for conversions of a home currency subtotal or merchandise subtotal to equivalent of another country's currency.

Use this key for conversions of another country's currency to the equivalent of the home currency.

Declaration

Use this key to declare in drawer amount for money declaration.

Department

Use this key to register department.

Department number

Use this key to enter department number.

Deposit

Use this key to register deposits.

Dutch account

Use this key to share the total payment by customers.

Eat-in

Use this key to specify if the customer eats in the restaurant. Before closing a transaction press this key.

Electronic journal display

Use this key to display the stored journal.

1st unit price

Use this key to register a specific item at the first unit price.

House Bon

Use this key to register items for in-store use.

Loan

Use this key to input the amount of money provided making change.

List

Use this key to display menu lists.

List number

Use this key to enter list number.

Ketten Bon

Use this key to enter quantities for multiplication. Multiplication by this key issues singular order prints.

Media change

Use this key to change media in drawer amounts.

Merchandise subtotal

Use this key to obtain subtotal excluding the add-on tax amount and the previous balance.

New check

Use this key in a check tracking system to input a new check number in order to open a new check under that number.

No sale

Use this key to open the drawer between transaction.

Non-add

Use this key to print reference numbers (personal check number, card number, etc.)

Normal receipt

Use this key to change the order status from Bon to normal.

OBR (Optical barcode reader)

Use this key to input optical barcodes manually.

Old check

Use this key in a check tracking system to input the number of an existing check (previously created by the New check key) whose details are stored in the check tracking memory. Existing checks are reopened to perform further registration or to finalize them.

Open 2

Use this key to suspend the compulsory specifications.

Open check

Use this key to issue an open check report of an assigned clerk.

Operator number

Use this key to enter a clerk number during clerk transfer.

Operator X/Z

Use this key to issue a clerk's individual X/Z report.

PLU number

Use this key to enter PLU number.

Plus

Use this key for registering surcharge.

Pick up

Use this key to pick up media in drawer.

Premium

Use this key to apply a preset % or manual input % to obtain the premium amount for the last registered item or subtotal.

Price

Use this key to register an open PLU.

Price inquiry

Use this key to confirm the price and descriptors of PLU without registering.

Post entry

Use this key to indicate the reserved item of set menu and register it as a fixed item later on.

Quantity/for

This key provides the same functions as the multiplication key. In addition, this key also has a split price function.

Recall

Use this key for recalling the transferred check number by the store key. When this key is pressed, the check number will appear in order of the oldest record.

Reverse display

Use this key to reverse the LCD color.

Round repeat

Use this key to register the same items which were ordered just before.

Seat number

Use this key to enter and print seat number.

2nd unit price

Use this key to register a specific item at the second unit price.

Separate check

Use this key in a check tracking system to separate selected items from one check to another check.

Selective item subtotal

Use this key to obtain the selective item 1/2 of subtotal amount.

Shift PLU

Use this key to shift flat-PLU key to the n-th (1 ~ 8) level.

Slip feed/release

Use this key to feed slips inserted into the slip printer. This is done by specifying the number of feed lines. This key is also used to release the slip paper holder if numbers are not entered.

Slip back feed/release

Use this key to back feed slips inserted into the slip printer. This is done by specifying the number of feed lines. This key is also used to release the slip paper holder if numbers are not entered.

Slip print

Use this key to execute a slip batch printing on the slip printer. Pressing this key prints the sales details. Actual printing is performed following receipt issuance.

Square

This key provides the same functions as the Multiplication key. In addition, this key also has a square multiplication function.

Stock inquiry

Use this key to check the current stock quantity for a PLU without registering.

Store

Use this key for storing the check number of the registered items. When this key is pressed, registered item data will be stored, and then these data will transfer to the youngest check number.

Subdepartment

Use this key to register items for the subdepartment.

Subdepartment number

Use this key to enter subdepartment number.

Substitution

Use this key to replace group PLU with a PLU which is not preset in the pulldown menu.

Table number

Use this key to input table numbers.

Takeout

Use this key to specify if the customer takes out items, before total a transaction. Press this key for the tax exemption.

Tax exempt

Use this key to change taxable amounts to nontaxable amounts.

Tax shift

Use this key to activate the tax table which is specified by the same tax status programmed for this key.

Taxable amount subtotal

Use this key to obtain taxable amount subtotal.

Text print

Use this key to enter characters to print.

Text recall

Use this key to print preset characters.

Tip

Use this key to register tips.

Tray total

Use this key to display the total amount for all registrations from the last registration until this key is pressed or registrations between presses of this key.

Validation

Use this key to validate item or transaction amounts on the slip.

VAT

Use this key to print VAT breakdowns.

Introducing TE-8000F/8500F

How to remove/replace the sheet holder (TE-8000F only)

Remove the sheet holder

Follow steps 1 ~ 2.

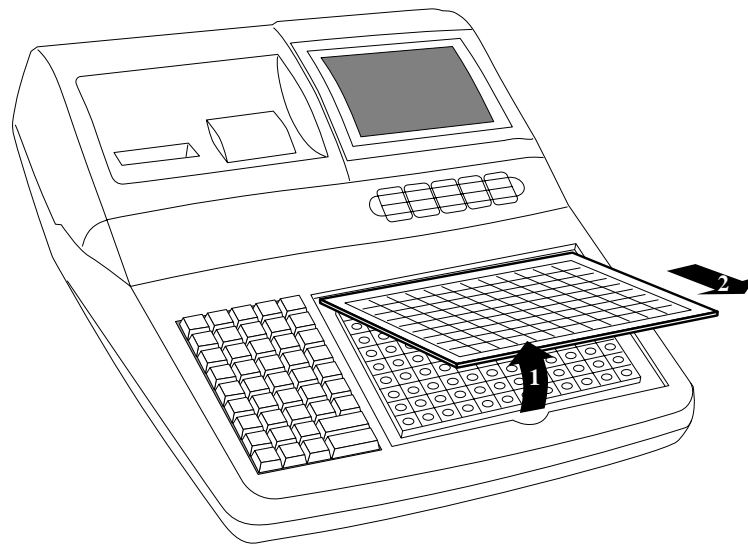

Replace the sheet holder

Follow steps 3 ~ 4.

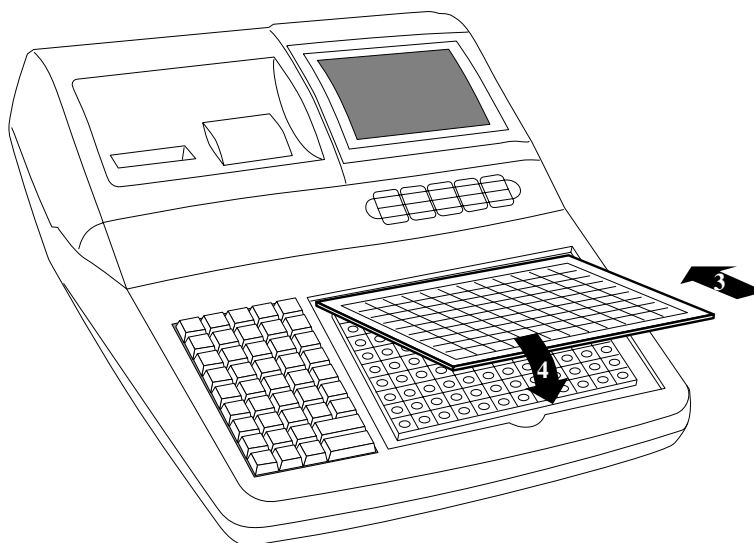

How to install a menu sheet in the sheet holder (TE-8000F only)

Open the sheet holder

Follow the steps 1 ~ 3.

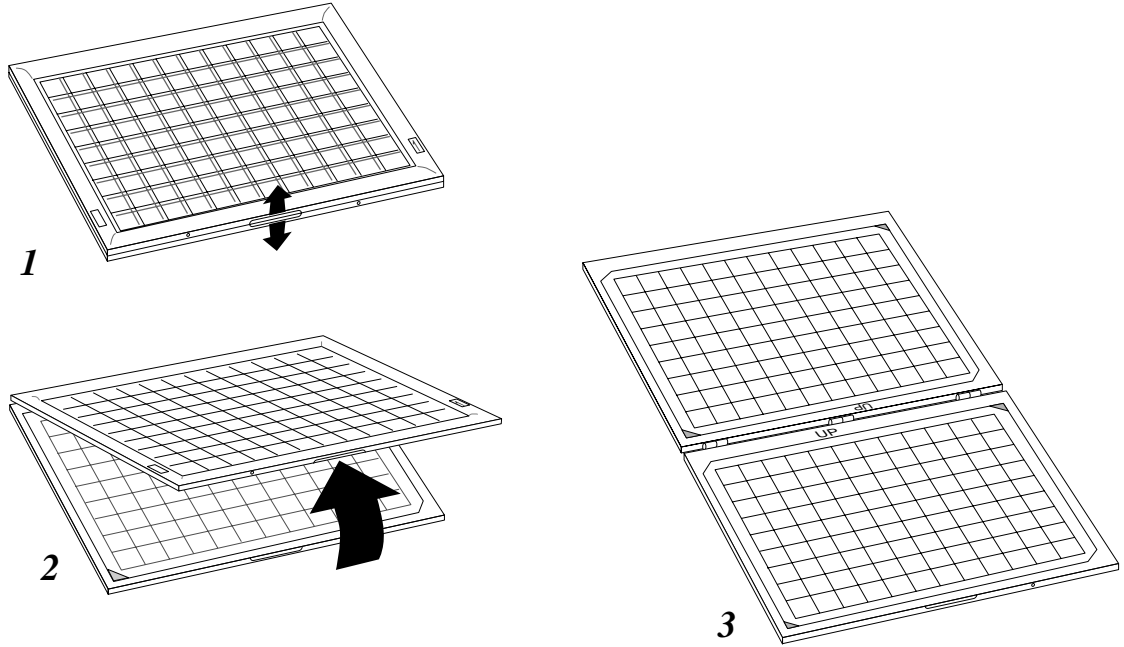

Set a menu sheet in the sheet holder

Follow the steps 4 ~ 6.

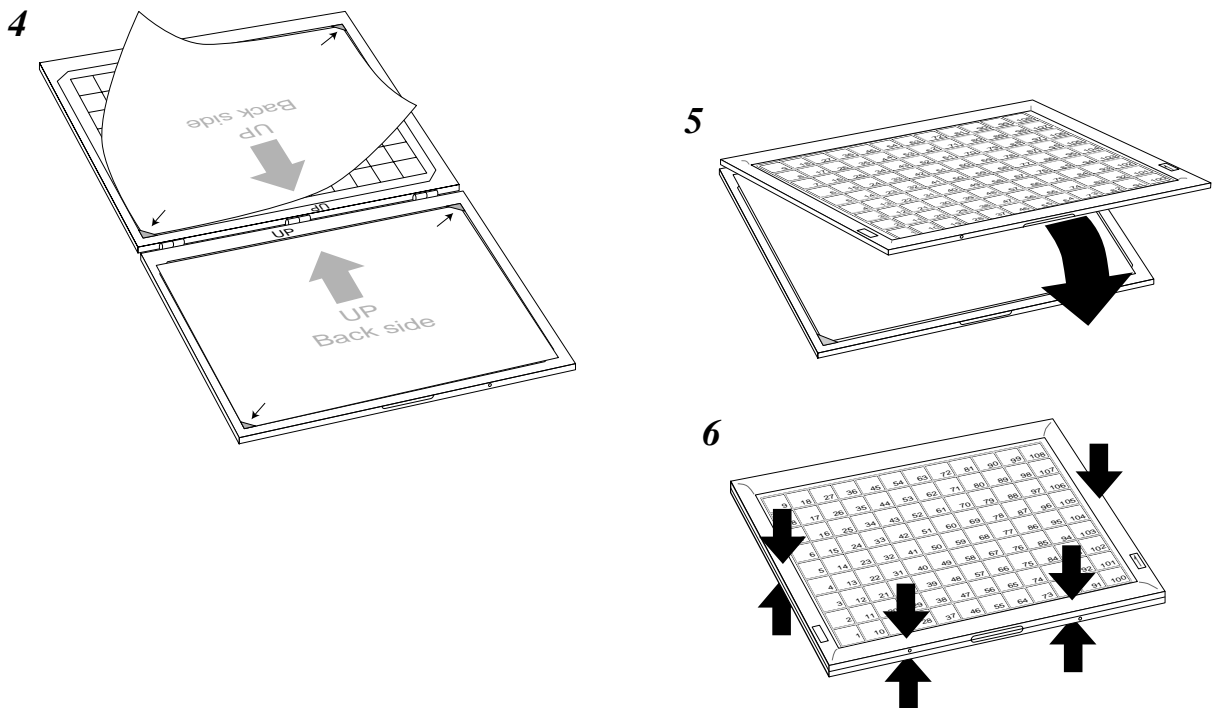

How to read the printouts

- The journal and receipts are records of all transactions and operations.
- The contents printed on receipts and journal are almost identical.
- The following items can be skipped on receipts and journal.
 - Consecutive number
 - Taxable status
 - Taxable amount
 - Item counter

```

***** LOGO MESSAGE *****
***** LOGO MESSAGE *****
***** LOGO MESSAGE *****
***** LOGO MESSAGE *****

* COMMERCIAL MESSAGE *
* COMMERCIAL MESSAGE *
* COMMERCIAL MESSAGE *
* COMMERCIAL MESSAGE *

REG      03-04-2003 11:58 AM
C01      MC #01      000123
#012345  COVERS 12
CHECK No. 123456

1 PLU0001      T1      -1.00
1 PLU0002      T1      -2.00
5 PLU0003      T1      -5.00
          7 No
TA1           -3.00
TX1           -0.15
TL           - 8.15
CASH         -10.00
CG           -1.85

***** BOTTOM MESSAGE *****
***** BOTTOM MESSAGE *****
***** BOTTOM MESSAGE *****
***** BOTTOM MESSAGE *****
    
```

Receipt Sample

Logo message

Commercial message

Mode/Date/Time
 Clerk/Machine No./Consecutive No.
 Table No./Customer No.
 Check No.

Quantity/Item name/Tax/Amount

Item counter
 Taxable amount
 Tax amount
 Total amount
 Amount tendered
 Change due

Bottom message

```

1 PLU0001      T1      -2.00
5 PLU0003      T1      -5.00
          7 No
TA1           -3.00
TX1           -0.15
TL           - 8.15
CASH         -10.00
CG           -1.85
REG      03-04-2003 12:00 PM
    
```

**Journal Sample
 (by half height character)**

```

REG      03-04-2003 11:58 AM
C01      MC #01      000123
NEW/OLD   123456
CT        12
TBL#      12345
1 PLU0001      T1      -1.00
1 PLU0001      T1      -1.00
1 PLU0002      T1      -2.00
5 PLU0003      T1      -5.00
          7 No
TA1           -3.00
TX1           -0.15
TL           - 8.15
CASH         -10.00
CG           -1.85
REG      03-04-2003 12:00 PM
C01      MC #01      000124
#012345  CT        10
    
```

Mode/Date/Time
 Clerk/Machine No./Consecutive No.
 Check No.
 Customer No.
 Table No.
 Quantity/Item name/Tax/Amount
 Item counter
 Taxable amount
 Tax amount
 Total amount
 Amount tendered
 Change due

Journal Sample

In the operation examples contained in this manual, the print samples are what would be produced if the roll paper is being used for receipts. They are not actual size. Actual receipts are 58 mm wide. Also, all sample receipts and journals are printout images.

How to use your cash register

The following describes the general procedure you should use in order to get the most out of your cash register.

BEFORE business hours...

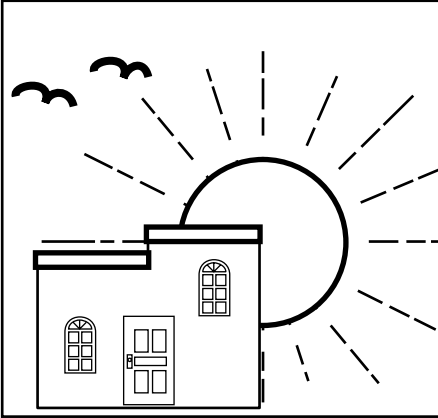

- Check to make sure that the cash register is plugged in securely. Page 11
- Check to make sure there is enough paper left on the roll. Pages 12, 13
- Read the financial totals to confirm that they are all zero. Page 89
- Check the date and time. Page 31

DURING business hours...

- Register transactions. Page 32
- Periodically read totals. Page 88

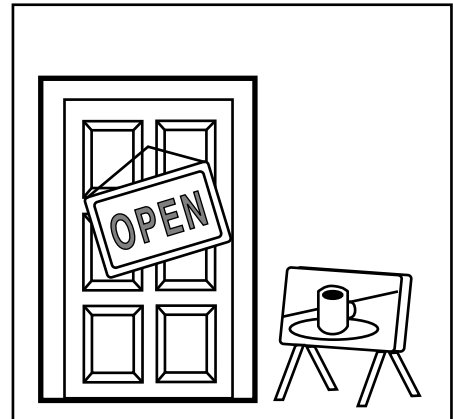

AFTER business hours...

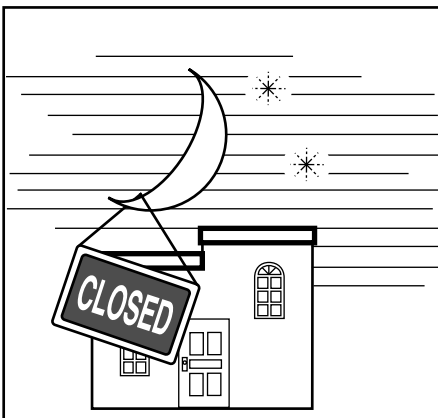

- Reset the daily totals. Page 48
- Remove the journal. Page 105
- Empty the cash drawer and leave it open. Page 19
- Take the cash and journal to the office.

Basic Operations and Setups

Assigning a clerk



In Germany, you can assign clerks by touching with a Dallas key on the receiver or by clerk number.

In other areas, you can assign clerks by using clerk button or by clerk secret number.

The method you of assigning clerk depends on the programming of your cash register.

Clerk button

You can assign the clerk or cashier using the four (“CLK1” thru “CLK4”) buttons located below the display panel.

Dallas key

You can assign the clerk or cashier by touching with a Dallas key on the receiver.

Clerk number key

The **CLK5** key is assigned as the clerk secret number key.

Clerk sign on

	Clerk button	OPERATION Clerk secret number	Dallas key
Signing clerk 1 on:	CLK1	* 1 CLK5	touch with Dallas key 1
Signing clerk 2 on:	CLK2	* 2 CLK5	touch with Dallas key 2
		⋮	⋮
Signing clerk 6 on:	--	* 6 CLK5	touch with Dallas key 6

Clerk secret number
(1 ~ 6 is set as default.)

* If you do not want the clerk secret number to be shown on the display, press **CLK5** before entering the number.

Clerk sign off

	OPERATION
Signing clerk off:	0 CLK1 (~ CLK5)

- The current clerk is also signed off whenever you turn off the register or finalize a transaction.

Important!

- A clerk cannot sign on unless other clerk is signed off.
- The signed on clerk is identified on the receipt/journal.

Displaying the time and date



You can show the time or date on the display of the cash register whenever there is no registration being made.

To display and clear the date/time

OPERATION

DISPLAY



Date/time appears on the display.

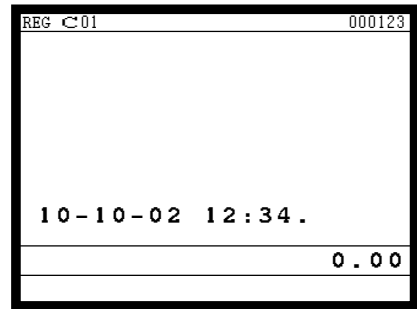

Clears the date/time display.

Preparing coins for change



You can use the following procedure to open the drawer without registering an item. This operation must be performed out of a sale.
(You can use the **RC** key instead of the **#/NS** key. See page 44.)

Opening the drawer without a sale

OPERATION

RECEIPT



No receipt is issued.

Preparing and using flat-PLU keys

Registering flat-PLU keys



The following examples show how you can use the flat-PLU keys in various types of registrations.

Single item sale

Example 1

OPERATION

RECEIPT

Item	Unit price	\$1.00
	Quantity	1
	Flat-PLU	1
Payment	Cash	\$1.00

1 00
Unit price

001
Flat-PLU

CA/AMT
TEND

REG	03-04-2003	09:05	Mode/Date/time
C01	MC #01	000002	Clerk/machine No. /consecutive No.
1 PLU0001		.1.00	PLU No./unit price
TL		- 1.00	Total amount
CASH		.1.00	

Example 2 (Subtotal registration and change computation)

OPERATION

RECEIPT

Item	Unit price	\$12.34
	Quantity	1
	Flat-PLU	1
Payment	Cash	\$20.00

1 2 3 4
Unit price

001
Flat-PLU

**SUB
TOTAL**

2 0 00 CA/AMT
TEND

Amount tendered

REG	03-04-2003	09:10	Mode/Date/time
C01	MC #01	000003	Clerk/machine No. /consecutive No.
1 PLU0001		.12.34	Total amount
TL		- 12.34	Amount tendered
CASH		.20.00	Change
CG		.7.66	

Repeat, menu shift

OPERATION

RECEIPT

Item 1	Unit price	\$1.50
	Quantity	3
	Flat-PLU	1
Item 2	Unit price	\$2.50
	Quantity	2
	Flat-PLU	109*
Payment	Cash	\$10.00

1 5 0 **001**

001

001

**MENU
SHIFT** or turnover the menu
sheet (TE-8000F)

001

001

**SUB
TOTAL**

1 0 00 CA/AMT
TEND

REG	03-04-2003	09:15	Mode/Date/time
C01	MC #01	000004	Clerk/machine No. /consecutive No.
1 PLU0001		.1.50	Repeat
1 PLU0001		.1.50	
1 PLU0001		.1.50	
1 PLU0109		.2.50	Repeat
1 PLU0109		.2.50	
TL		- 9.50	Total amount
CASH		.10.00	Amount tendered
CG		.0.50	Change

* PLU 107 for TE-8500F.

Multiplication

Item	Unit price	\$1.00
	Quantity	12
	Flat-PLU	1
Payment	Cash	\$20.00

OPERATION

1 2 X
Quantity
(4-digit integer/2-digit decimal)

1 00 001

2 0 00 CA/AMT/TEND

SUB TOTAL

RECEIPT

REG 03-04-2003 09:20
C01 MC #01 000005

12 PLU0001 . 12.00 — Quantity/result

12X @1/ 1.00 — Quantity/unit q'ty/@
12 PLU0001 . 12.00 — Result

TL - 12.00
CASH . 12.00

Programming to flat-PLU

Flat-PLU unit price programming procedure

- Step 1. Press <PGM MODE> to turn “PGM-1” and press **YES**.
- Step 2. Select “1.PLU” and press **YES**.

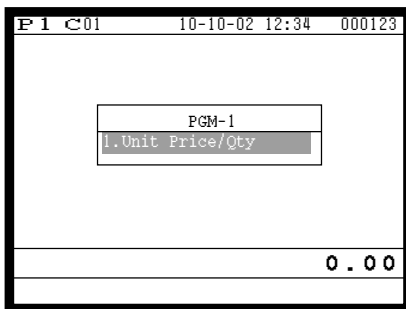

Step 1. screen

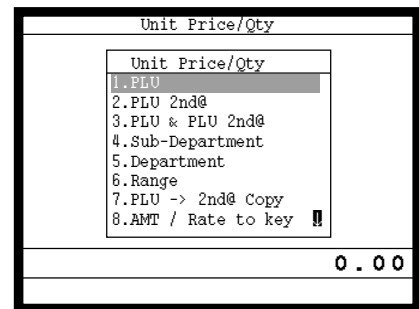

Step 2. screen

- Step 3. Select the PLU record you want to program by pressing the flat-PLU key directly, by entering PLU record No. and **YES**, or by entering random PLU code and **PLU**.
- Step 4. Enter appropriate unit price and **YES**.

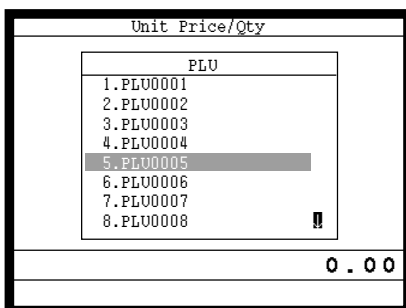

Step 3. screen

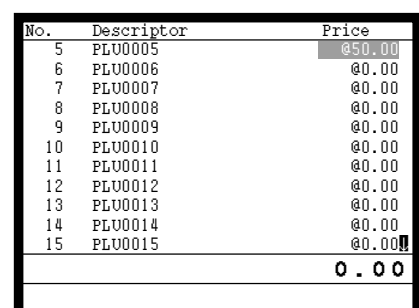

Step 4. screen

- Step 5. Repeat the step 4., if you program the next record.
Press **ESC/SKIP** and repeat the step 3. and 4., if you program to the other record.
- Step 6. Press **ESC/SKIP** repeatedly to return to the “Step 1. screen”.

Basic Operations and Setups

Flat-PLU department link/tax status/listing capacity programming procedure

Step 1. Press <PGM MODE> three times to turn “PGM-3”.

Step 2. Select “3.Key Feature” and press , then select “1.PLU” and press .

Step 1. screen

Step 2. screen

Step 3. Select the PLU record you want to program by pressing the flat-PLU key directly, by entering PLU record No. and , or by entering record No./random PLU code and .

Step 4. Link department programming:

Select “Dept Link” line, press , select the appropriate link department and .

Tax status programming:

Select “Taxable status” line, and press select the appropriate tax status.

Listing capacity programming:

Select “High Amount Limit” line (press three times), and enter the amount and press .

Step 3. screen

Step 4-1. screen

Step 4-2. screen

Step 4-3. screen

Step 5. Press and repeat the step 3. and 4., if you program to the other record.

Step 6. Press repeatedly to return to the “Step 1. screen”.

Registering flat-PLU keys by programming data



Preset price

OPERATION

RECEIPT

Item	Unit price	(\$1.00) _{preset}
	Quantity	1
	Flat-PLU	2
Payment	Cash	\$1.00

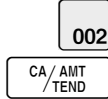

REG	03-04-2003 09:30
C01	MC #01 000007
1 PLU0002	.1.00
TL	- 1.00
CASH	.1.00

Preset tax status

OPERATION

RECEIPT

Item 1	Unit price	(\$2.00) _{preset}
	Quantity	5
	Flat-PLU	3
	Taxable	(1) _{preset}
Item 2	Unit price	(\$2.00) _{preset}
	Quantity	1
	Flat-PLU	4
	Taxable	(2) _{preset}
Payment	Cash	\$20.00

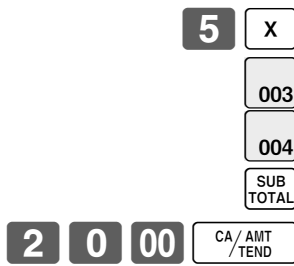

REG	03-04-2003 09:35
C01	MC #01 000008
5 PLU0003	T1 .10.00
1 PLU0004	T2 .2.00
TA1	.10.00
TX1	.0.40
TA2	.2.00
TX2	.0.20
TL	- 12.60
CASH	.20.00
CG	.7.40

Tax status
Taxable Amount 1
Tax 1
Taxable Amount 2
Tax 2

* Before this registration, tax table programming is necessary.

Locking out high amount limitation

OPERATION

RECEIPT

Item	Unit price	\$1.05
	Quantity	1
	Flat-PLU	3
	Max.amount	(\$10.00) _{preset}
Payment	Cash	\$2.00

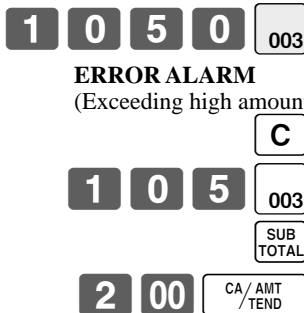

REG	03-04-2003 09:40
C01	MC #01 000009
1 PLU0003	.1.05
TL	- 1.05
CASH	.2.00
CG	.0.95

Preparing and using discounts/reductions

This section describes how to prepare and register discounts/reductions.

Programming discount rate and reduction amount

Step 1. Press <PGM MODE> to turn “PGM-1” and press .

Step 2. Select “8.AMT / Rate to key” and press .

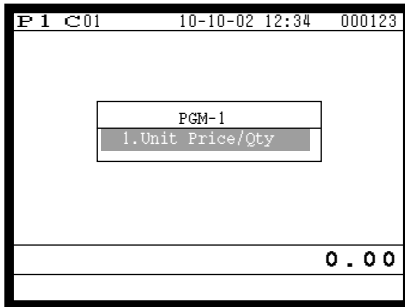

Step 1. screen

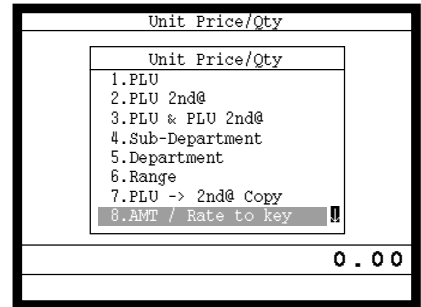

Step 2. screen

Step 3. Discount rate: Enter discount rate and press the .

Reduction amount: Enter reduction amount and press the .

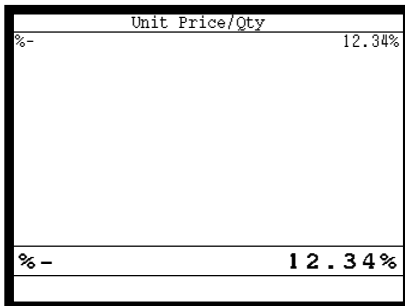

Step 3-1. screen

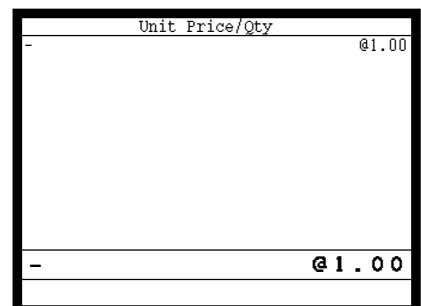

Step 3-2. screen

Step 4. Press repeatedly to return to the “Step 1. screen”.

Registering discounts



The following example shows how you can use the key in various types of registration.

Discount for items and subtotals

OPERATION			RECEIPT		
			5	00	<input type="text" value="001"/>
Item 1	Unit price	\$5.00			
	Flat-PLU	1			<input type="text" value="002"/>
	Taxable	(1) _{preset}			<input type="text" value="%-"/>
			Applies the preset discount rate to the last item registered.		
Item 2	Unit price	(\$10.00) _{preset}			<input type="text" value="SUB TOTAL"/>
	Flat-PLU	2			<input type="text" value="3"/>
	Taxable	(2) _{preset}			<input type="text" value="."/>
					<input type="text" value="5"/>
			The input value takes priority of the preset value.		
Discount	Rate	(5%) _{preset}			<input type="text" value="%-"/>
Subtotal discount	Rate	3.5%			<input type="text" value="SUB TOTAL"/>
	Taxable	Nontaxable			<input type="text" value="1"/>
Payment	Cash	\$15.00			<input type="text" value="5"/>
					<input type="text" value="00"/>
					<input type="text" value="CA/AMT TEND"/>

REG 03-04-2003 10:15
 C01 MC #01 000016

1 PLU0001 T1 -5.00
 1 PLU0002 T2 -16.00
 5%
 %- T2 -0.50
 ST -14.50
 3.5%
 %- -0.51
 TA1 -5.00
 TX1 -0.20
 TA2 -9.50
 TX2 -0.48
 TL -14.67
 CASH -15.00
 CG -0.33

- You can manually input rates up to 4 digits long (0.01% to 99.99%).

Taxable status of the key

- Whenever you perform a discount operation on the last item registered, the tax calculation for discount amount is performed in accordance with the tax status programmed for that item.
- Whenever you perform a discount operation on a subtotal amount, the tax calculation for the subtotal amount is performed in accordance with the tax status programmed for the key.

Basic Operations and Setups

Registering reductions









The following examples show how you can use the  key in various types of registration.

Reduction for items

Item 1	Unit price	\$5.00
	Flat-PLU	1
	Taxable	(1) _{preset}
Reduction	Amount	\$0.25
Item 2	Unit price	(\$6.00) _{preset}
	Flat-PLU	2
	Taxable	(1) _{preset}
Reduction	Amount	(\$0.50) _{preset}
Payment	Cash	\$11.00

OPERATION



 Reduces the last amount registered by the value input.





RECEIPT







REG	03-04-2003	10:20
C01	MC #01	000017
1 PLU0001	T1	-5.00
-	T1	-0.25
1 PLU0002	T1	-6.00
-	T1	-0.50
TA1		-10.25
TX1		-0.41
TL		- 10.66
CASH		-11.00
CG		-0.34

- You can manually input reduction values up to 7 digits long.
- If you want to subtract the reduction amount from the department or PLU totalizer, program “Net totaling.”

Reduction for subtotal

Item 1	Unit price	\$3.00
	Flat-PLU	1
	Taxable	(1) _{preset}
Item 2	Unit price	\$4.00
	Flat-PLU	2
	Taxable	(2) _{preset}
Subtotal	Amount	\$0.75
Reduction	Taxable	(No) _{preset}
Payment	Cash	\$7.00

OPERATION





 Reduces the subtotal by the value input here.

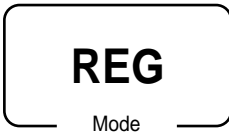

RECEIPT

REG	03-04-2003	10:25
C01	MC #01	000018
1 PLU0001	T1	-3.00
1 PLU0002	T2	4.00
-		-0.75
TA1		-3.00
TX1		-0.12
TA2		-4.00
TX2		-0.20
TL		- 6.57
CASH		-7.00
CG		-0.43

Registering credit and check payments

The following examples show how to register credits and payments by check.



Check

OPERATION			RECEIPT			
Item	Unit price	\$11.00	1	1	00	REG 03-04-2003 10:30 C01 MC #01 000019 1 PLU0001 .11.00 TL - 11.00 CHECK .20.00 CG .9.00
	Flat-PLU	1				
Payment	Check	\$20.00	2	0	00	
						001
						SUB TOTAL
						CHK/ TEND

Credit

OPERATION			RECEIPT			
Item	Unit price	\$15.00	1	5	00	REG 03-04-2003 10:35 C01 MC #01 000020 1 PLU0001 .15.00 #/NS 1234 TL - 15.00 CREDIT .15.00
	Flat-PLU	1				
Reference	Number	1234	1	2	3	
Payment	Credit	\$15.00				#/ NS
						001
						SUB TOTAL
						CR

Reference No.

Mixed tender (cash, credit and check)

OPERATION			RECEIPT			
Item	Unit price	\$55.00	5	5	00	REG 03-04-2003 10:40 C01 MC #01 000021 1 PLU0001 .55.00 TL - 55.00 CHECK .30.00 CASH .5.00 CREDIT .20.00
	Flat-PLU	1				
Payment	Check	\$30.00	3	0	00	
						001
						SUB TOTAL
						CHK/ TEND
						CA/ AMT TEND
						CR

Registering both the Euro and local currency

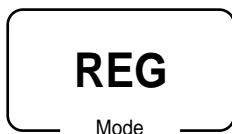

The following example shows the basic operation using the currency exchange function between the Euro and the local currency.

Case A

Main currency	Local
Payment	Euro
Change	Local
Rate	1 Euro = 0.5 FFr

OPERATION

6 0 0 001

PD

← Press the PD key, which converts the subtotal amount into the sub currency by applying the preset exchange rate. And the subtotal in the sub currency is shown on the display.

1 5 00 CA/AMT/TEND

← Press the CA/AMT/TEND key to finalize the transaction. The change amount is shown in the programmed currency.

DISPLAY

REG C01	03-04-03 10:45	000023
PLU0001		-6.00
TL		-6.00
		EUR12.00
CASH		EUR15.00
	-7.50	
CG		-1.50
	EUR3.00	
CG		EUR3.00

RECEIPT

REG	03-04-2003 10:45
C01	MC #01 000022
1 PLU0001	-6.00
TL	-6.00
	EUR12.00
CASH	EUR15.00
	-7.50
CG	-1.50
	EUR3.00

Case B

Main currency	Euro
Payment	Local
Change	Euro
Rate	1 Euro = 0.5 FFr

OPERATION

1 2 00 001

PD

↩ Press the PD key, which converts the subtotal amount into the sub currency by applying the preset exchange rate. And the subtotal in the sub currency is shown on the display.

6 00 CA/AMT/TEND

↩ Press the CA/AMT/TEND key to finalize the transaction. The change amount is shown in the programmed currency.

DISPLAY

REG C01	03-04-03 10:45	000024
PLU0001		EUR12.00
TL	EUR12.00	
		-6.00
CASH		-6.00
	EUR12.00	
CG		EUR0.00
	-0.00	
CG		• 0 . 0 0

RECEIPT

REG	03-04-2003 10:50
C01	MC #01 000024
1 PLU0001	EUR12.00
TL	EUR12.00
	-6.00
CASH	-6.00
	EUR12.00
CG	EURO.00
	-0.00

Registering returned goods in the REG mode



The following example shows how to use the **RF** key in the REG mode to register goods returned by customers.

OPERATION

RECEIPT

Item 1	Unit price	\$2.35
	Flat-PLU	1
Item 2	Unit price	\$2.00
	Flat-PLU	2
Item 3	Unit price	(\$1.20) _{preset}
	Flat-PLU	3
Returned Item 1	Unit price	\$2.35
	Flat-PLU	1
Returned Item 3	Unit price	(\$1.20) _{preset}
	Flat-PLU	3
Payment	Cash	\$2.00

2 3 5 **001**
2 00 **002**
003
RF
2 3 5 **001**
 Press **RF** before the item you want to return.
RF
003
SUB TOTAL
CA/AMT TEND

REG	03-04-2003	11:00
C01	MC #01	000025
1 PLU0001		-2.35
1 PLU0002		-2.00
1 PLU0003		-1.20
RF	
1 PLU0001		-2.35
RF	
1 PLU0003		-1.20
TL		-2.00
CASH		-2.00

Registering returned goods in the REF mode

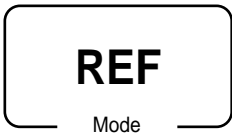

The following examples show how to use the REF mode to register goods returned by customers.

First of all, press <REG MODE> key repeatedly to turn the REF mode.

Normal refund transaction

OPERATION			RECEIPT	
Returned Item 1	Unit price	\$1.50	1	5
	Quantity	2	0	001
Returned Item 2	Unit price	(\$1.20) _{preset}	6	X
	Quantity	6	003	CA/AMT TEND
Payment	Cash	\$10.20		

RF mode symbol

RF	03-04-2003	11:05		
C01	MC #01	000026		
1	PLU0001	-1.50		
1	PLU0001	-1.50		
6	PLU0003	-7.20		
	TL	-10.20		
	CASH	-10.20		

Reduction of amounts paid on refund

OPERATION			RECEIPT	
Returned Item 1	Unit price	\$4.00	4	00
	Quantity	1	1	5
Reduction	Amount	\$0.15	-	003
Returned Item 2	Unit price	(\$1.20) _{preset}	%	-
	Quantity	1	SUB TOTAL	CA/AMT TEND
Discount	Rate	(5%) _{preset}		
Payment	Cash	\$5.20		

RF	03-04-2003	11:10		
C01	MC #01	000027		
1	PLU0003	T1 -4.00		
	-	T1 -0.15		
1	PLU0003	T2 -1.20		
	5%			
	%-	T2 -0.06		
	TA1	-3.85		
	TX1	-0.15		
	TA2	-1.14		
	TX2	-0.06		
	TL	-5.20		
	CASH	-5.20		

Important!

- To avoid miss registrations in the REF mode, return the mode to the former position immediately.

Registering money received on account

REG
Mode

The following example shows how to register money received on account. This registration must be performed out of a sale.

Received amount	\$700.00
-----------------	----------

OPERATION

7 00 00 **RC**

Amount can be up to 8 digits.

RECEIPT

REG	03-04-2003	11:15
C01	MC #01	000028
RC		.700.00

Registering money paid out

REG
Mode

The following example shows how to register money paid out from the register. This registration must be performed out of a sale.

Paid out amount	\$1.50
-----------------	--------

OPERATION

1 5 0 **PD**

Amount can be up to 8 digits.

RECEIPT

REG	03-04-2003	11:20
C01	MC #01	000029
PD		.1.50

Making corrections in a registration

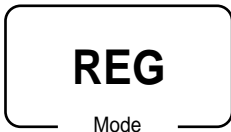

There are four techniques you can use to make corrections in a registration.

- To correct an item that you input but not yet registered.
- To correct the last item you input and registered.
- To correct the item you registered previously in the transaction.
- To cancel all items in a transaction.

To correct an item you input but not yet registered

OPERATION

RECEIPT

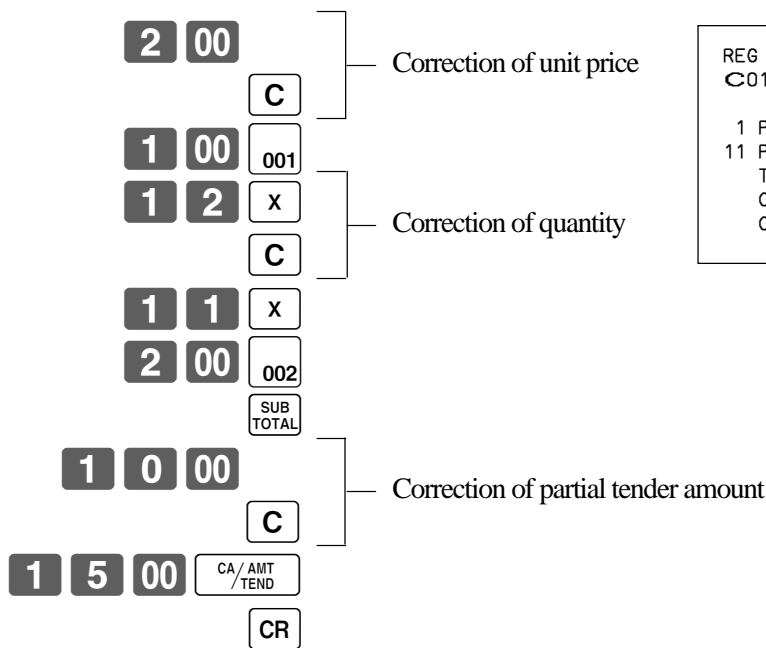

REG	03-04-2003	11:40
C01	MC #01	000033
1	PLU0001	.1.00
11	PLU0002	.22.00
	TL	-23.00
	CASH	.15.00
	CREDIT	.8.00

Basic Operations and Setups

To correct an item you input and registered

OPERATION

RECEIPT

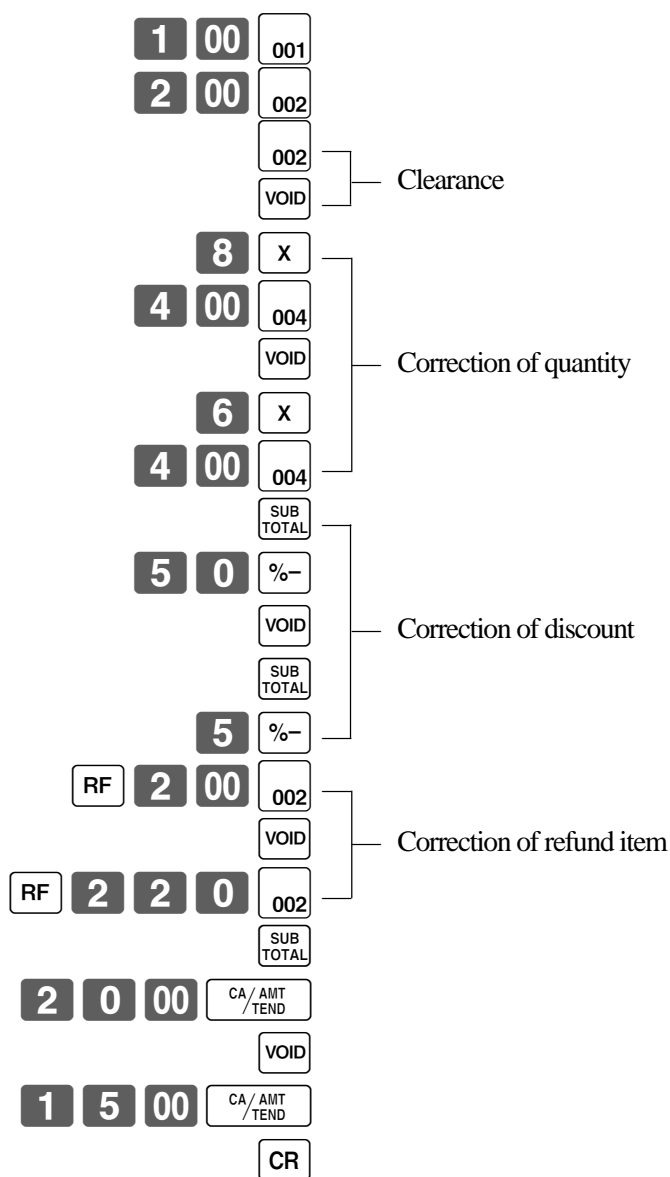

REG	03-04-2003 11:45	
C01	MC #01	000034
1 PLU0001		.1.00
1 PLU0002		.2.00
1 PLU0002		.2.00
VOID		-2.00
8 PLU0003		-32.00
VOID		-32.00
6 PLU0003		.24.00
ST		.38.50
50%		
%-		-19.25
VOID		.19.25
ST		.38.50
5%		
%-		-1.93
RF	
1 PLU0002		-2.00
VOID		.2.00
RF	
1 PLU0002		-2.20
TL		-34.37
CASH		.20.00
VOID		-20.00
CASH		.15.00
CREDIT		.19.37

* These items are printed on journal only.

To correct the item you registered previously in this receipt

OPERATION

RECEIPT

8 X
 1 00 001
 2 00 002
 3 00 003
 ↑
 ↑
 ↑
 VOID
 6 X
 1 00 001
 SUB
 TOTAL
 CA/AMT
 /TEND

Step three lines up to designate the item.

REG	03-04-2003	11:50
C01	MC #01	000035
1	PLU0002	.2.00
1	PLU0003	.3.00
6	PLU0003	.6.00
	TL	- 11.00
	CASH	.11.00

To cancel all items in a transaction

OPERATION

RECEIPT

1 00 001
 2 00 002
 3 00 003
 4 00 004
 CANCEL
 YES

REG	03-04-2003	11:55
C01	MC #01	000036
1	PLU0001	.1.00
1	PLU0002	.2.00
1	PLU0003	.3.00
1	PLU0004	.4.00
	CANCEL

Pressing **YES** key is necessary to cancel the transaction.

No sale registration

REG

Mode

You can use the following procedure to open the drawer without registering a sale. This operation must be performed out of a sale.

OPERATION

RECEIPT

#/NS

No receipt is issued.

Printing the daily sales reset report

This report shows daily sales totals.

Procedure

Step 1. Press <X/Z MODE> to turn “X/Z Report”.

Step 2. Select “4.Daily Z” and press .

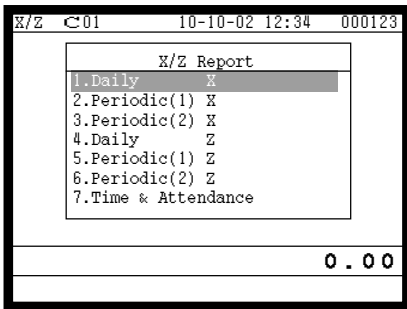

Step 1. screen

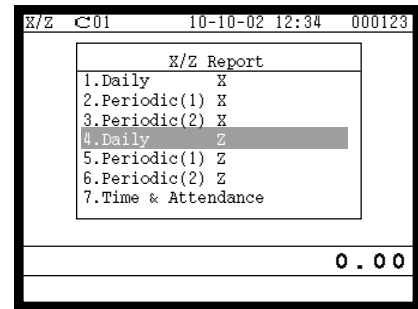

Step 2. screen

Step 3. Select “1.Batch” and press .

Step 4. Select “1.Batch(1)” and press .

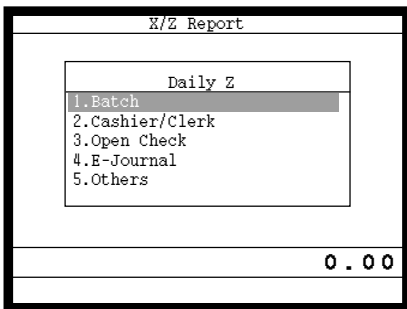

Step 3. screen

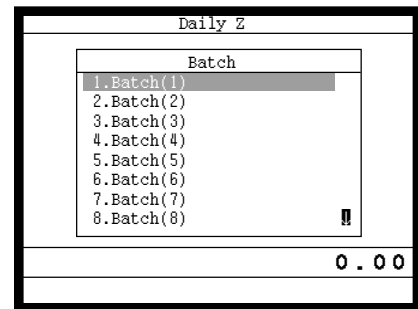

Step 4. screen

Step 5. Press repeatedly to return to the “Step 1. screen”.

Printout

Z	03-04-2003 17:00	Mode/date/time
C01	MC #01 000237	Clerk/Mc No./consecutive No.
Z	FIXED TTL 1	Report title/reset counter
	0001011	Report code
GROSS	981.250	Gross total *2
	-6,574.40	
NET	No 111	Net total *2
	-7,057.14	
CAID	-1,919.04	Cash in drawer *2
CKID	-859.85	Check in drawer *2
CRID	-709.85	Credit in drawer *2
RF	No 3	Refund mode *2
	-10.22	
DC	-1.22	Discount total *2
REF	-2.42	Refund key *2
CLEAR	No 85	Clear key count *2
TA1	-2,369.69	Taxable 1 amount *2
TX1	-128.86	Tax 1 amount *2
EX1	No 0	Taxable 2 amount *2
	-0.00	Tax 2 amount *2
TA2	-2,172.96	
TX2	-217.33	
EX2	No 0	
	-0.00	
TA10	-0.00	
TX10	-0.00	
EX10	No 0	
	-0.00	
GT1	-125478.96	Grand total 1 *2
GT2	-346284.23	Grand total 2 *2
GT3	-123212.75	Grand total 3 *2
Z	FREE FUNCTION 1	Report title/reset counter
	0001012	Report code
CASH	No 362	Function key count/amount *1
	-1,638.04	
CHECK	No 56	
	-1,174.85	
RC	No 4	
	-810.00	
PD	No 5	
	-520.00	
-	No 3	
	-410.00	
%-	No 5	
	-5.00	
VOID	No 14	
	-39.55	
RCT	No 3	
NS	No 5	
CANCEL	No 1	
	-100.28	

Z	DEPT 1	Report title/reset counter
	0001015	Report code
DEPT01	203.25	Department count/amount *1
	-1,108.54	
DISCOUNT	-10.00	Discount total
DEPT02	183	
	-1,362.26	
DISCOUNT	-0.00	
DEPT04	5	
	-17.22	
DISCOUNT	-0.00	
TL	421.25	Department total
	-2,872.28	
DISCOUNT	-12.08	
Z	CASHIER/CLERK 1	Report title/reset counter
	0001017	Report code
C011	Clerk name/drawer No. *1
GROSS	421.254	Gross total *1
	-2,872.28	
NET	No 111	Net total *1
	-1,845.35	
CAID	-1,057.14	Cash in drawer *1
CRID	-0.19	Credit in drawer *1
CKID	-9.02	Check in drawer *1
C021	Clerk name/drawer No.

*1 Zero totalled departments/functions/clerks are not printed by programming.

*2 These items can be skipped by programming.

Advanced Operations

This chapter describes more sophisticated operations that you can use to suit the needs of your retail environment.

Post-finalization receipt

The post-finalization receipt lets you issue a receipt after finalization of the transaction.

Note that all of the following conditions must be satisfied.

- The receipt issuance status must be OFF.
- The transaction must be finalized in the REG, REF or REG- mode using <CASH>, <CHARGE>, <CREDIT> or <CHECK>.

Receipt example

OPERATION		
Item 1	Flat 1	\$10.00
	Quantity	1
Item 2	Flat 2	\$20.00
	Quantity	1
Payment	Cash	\$30.00

1 0 00 001

2 0 00 002

SUB
TOTAL

3 0 00

CA / AMT
/ TEND

Receipt is not issued.
Sign on a clerk. (if necessary)

RECEIPT

Post-finalization receipt is issued.

RECEIPT

REG	03-04-2003	13:00
C01	MC #01	001050
1	PLU0001	.10.00
1	PLU0002	.20.00
	TL	- 30.00
	CASH	.30.00
	CG	.00

Important!

- After initialization, the register can issue only one post-finalization receipt per transaction.

NOTE

- This key is used for "GUEST RECEIPT" key in check tracking operation.

Inputting the number of customers

Example 1

OPERATION			RECEIPT		
Customer	Number	2			
Item 1	Flat 1	\$15.00	1	5	00
	Quantity	1			
Item 2	Flat 2	\$5.00	5	00	
	Quantity	1			
Payment	Cash	\$20.00	2	0	00

2 COVERS
 1 5 00 001
 5 00 002
 SUB TOTAL
 2 0 00 CA/AMT/TEND

REG	03-04-2003	13:10
C01	MC #01	001051
		2CT
1	PLU0001	.15.00
1	PLU0002	.5.00
	TL	-20.00
	CASH	.20.00
	CG	.0.00

Example 2

You can only use the following operation to re-input the number of customers when (customer number key) is preset to allow re-input. When programming prohibits re-input of the number of customers, this operation causes an error.

OPERATION			RECEIPT		
			3	COVERS	
			1	5	00
					001
			5	00	002
			2	COVERS	
					SUB TOTAL
			2	0	00
					CA/AMT/TEND

REG	03-04-2003	13:15
C01	MC #01	001052
		2CT
1	PLU0001	.15.00
1	PLU0002	.5.00
	TL	-20.00
	CASH	.20.00
	CG	.0.00

You can re-input the number of customers either immediately after the initial input or during later registration.

Example 3

You can use the following operation to add customers to an original number of customers input (when addition to the number of the customer is allowed).

OPERATION			RECEIPT		
			3	COVERS	
			1	5	00
					001
			5	00	002
			2	COVERS	
					SUB TOTAL
			2	0	00
					CA/AMT/TEND

REG	03-04-2003	13:20
C01	MC #01	001055
		5CT
1	PLU0001	.15.00
1	PLU0002	.5.00
	TL	-20.00
	CASH	.20.00
	CG	.0.00

NOTE

- After initialization, the register does not print customer number on receipts.

Clerk interrupt function

There are two types of clerk interrupt function, illustrated by Procedure 1 and Procedure 2 below.

- In Procedure 1, each clerk possesses a unique clerk interrupt buffer, and so the clerk interrupt function gives each individual clerk the ability to perform an independent registration operation. In this case, each clerk is individually linked to a unique clerk interrupt buffer.
- In Procedure 2, multiple clerks use the same clerk interrupt buffer, and so a single clerk interrupt operation (clerk change during registration) can perform any registration that is in progress. In this case, multiple clerks are linked to a single clerk interrupt buffer.

In this procedure, “Allow clerk to open check No. belonging to another clerk” program is necessary.

Note the following important points concerning the clerk interrupt function.

- The register must be programmed to allow use of the clerk interrupt function.
- In the REG, REF, and REG– modes, clerks can be change while a transaction is in progress, making it possible for multiple clerks to simultaneously perform registrations using a single register.

For example, if clerk 1 is interrupted while registering a transaction, clerk 2 can use the same machine to register a different transaction. Then clerk 1 can continue the original registration from the point where it was interrupted.

Procedure 1

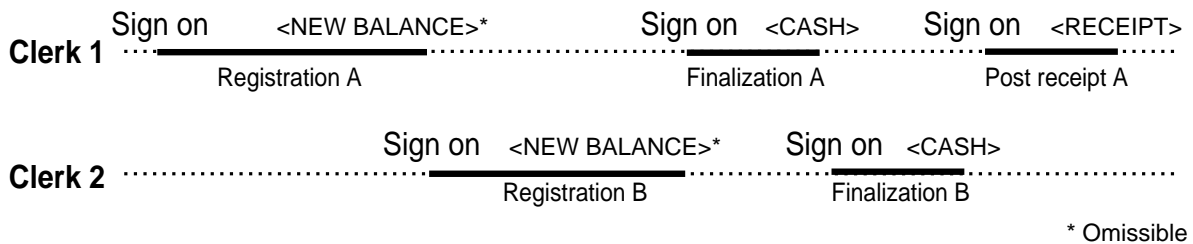

Procedure 2

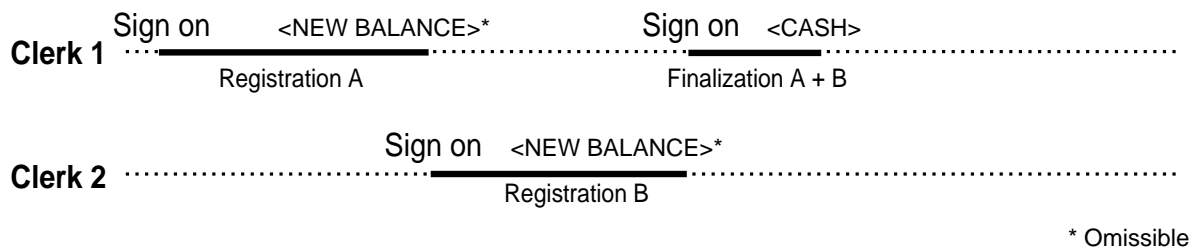

NOTES

- A cancel operation can be performed during registration by either of the clerks. When clerk 1 signs back on (after being interrupt by clerk 2), the cancel operation cancels only the items registered after signing back on (only this receipt) or from the top of the transaction. This is selectable by the key program.
- A <NB> key must be programmed in order to use clerk interrupt.

Printing slip

To perform batch printing on the slip printer, you must first connect the slip printer (SP-1300: option) and use the memory allocation operation (see program 5 mode in the programming manual) to reserve registration buffer memory. The capacity of the registration buffer memory is determined by the number of records of registration buffer memory reserved by the memory allocation operation.

There are two ways to print slips:

1. Print all items that are registered until the last slip printing.
2. Print only additional items that are registered until the last receipt issuance (ex. charge posting system).
If you select “option 2”, program “Auto Line Find” also.

Printing slips

The cash register can be connected to the optional SP-1300 slip printer, which features an automatic feed function and automatic back feed function.

• Automatic feed function

This function makes it possible to program the number of line feeds that should be inserted from the normal print start position before starting slip printing. Even if line feeds are programmed for this function, they are not inserted for validation printing, check endorsement printing, and check printing performed using the slip printer.

• Automatic back feed function

This function performs automatic back feed following slip printing, validation printing, and endorsement printing on the slip printer. The slip paper is released once the back feed operation is complete.

• Manual feed function

<SLIP FEED/RELEASE> (slip feed/release key: assigned to the register’s keyboard using the program 4 mode) can be used for manual feed of the slip paper. You perform manual feed by inputting a value for the number of lines (up to two digits in the range of 1 to 99) and then press <SLIP FEED/RELEASE>.

• Manual back feed function

<SLIP BACK FEED/RELEASE> (slip back feed/release key: assigned to the register’s keyboard using the program 4 mode) can be used for manual back feed of the slip paper. Manual back feed can be performed by inputting a value for the number of lines (up to two digits in the range of 1 to 99) and then press <SLIP BACK FEED/RELEASE>.

You can print slips using automatic or manual batch printing. The slip print operation can be performed in REG, REF, and REG– modes only.

Finalizing a registration without inserting a slip paper into the slip printer when the register is programmed as “Slip Automatic Batch Print Compulsory” produces an error.

To perform auto batch printing 1

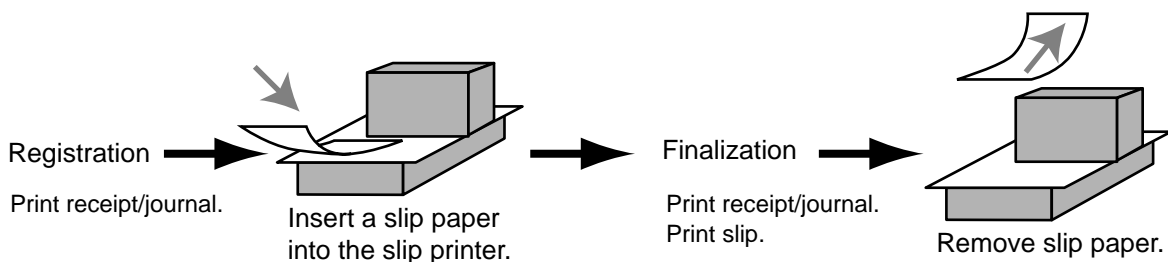

To perform auto batch printing 2

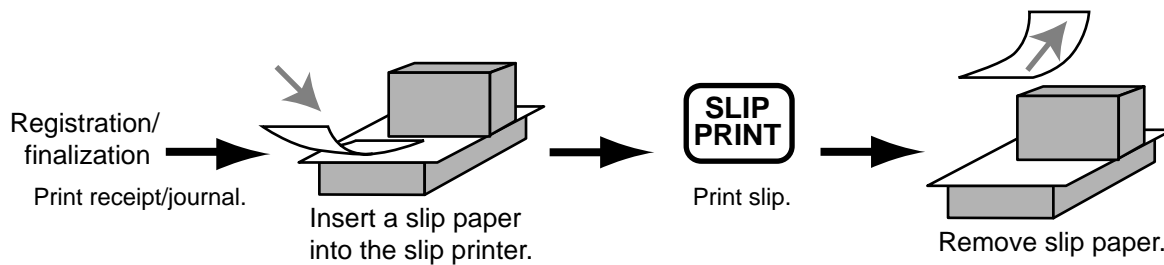

About the maximum number of slip lines

You can program the maximum number of lines that can be printed on a slip. Once you do, any attempt to exceed the preset maximum results in an error. When such an error occurs, change slip paper and press <SLIP PRINT> to restart printing.

Check tracking systems

Check tracking system

With the check tracking system, the amount, check number, number of slip print lines, machine number, date/time and registration detail data are stored in two files (check tracking index file and check tracking detail file).

- Check tracking detail file and index file are cleared by the following timing:
 1. Check number method: The same check number is not used during daily operation.
The check is cleared after printing finalized data on slip or guest check receipt, or the check is also cleared when the new or old check operation is made on the terminal finalized the transaction.
 2. Table number method: The same check number is used during daily operation.
The check is cleared after printing finalized data on slip or guest check receipt, or check is also cleared when the same finalized check number is assigned in new check operation.

You can select one of these options by programming.

- Auto new balance function
The register can be programmed so that whenever a clerk (by Dallas key) signs off while a check is open, a <NEW BALANCE> operation is automatically performed to temporarily finalize the open check.
- You can specify a range of checks that can be opened by each clerk. Once you do, any attempt by a clerk to open a check using a number that is not within his specified range results in an error.
- Either of the following two operations can be used to correct input of a wrong check number.
<NEW CHECK>, <NEW/OLD>
Re-input the correct check number, or cancel the original check number, issue a receipt, and then re-input the correct check number.
<OLD CHECK>, <NEW/OLD>
Temporary finalize the original check number, issue a receipt, and then re-input the correct check number.

Printing examples are described under “Print Additional item only” programming.

Opening a check

Example

OPERATION		RECEIPT
Check#	1234	
Table#	33	
Item 1	Flat 1	\$10.00
	Quantity	2
Item 2	Flat 2	\$20.00
	Quantity	2
Item 3	Flat 3	\$30.00
	Quantity	1

1 2 3 4 NEW CHECK
3 3 TABLE #
1 0 00 001
2 0 00 002
3 0 00 003
Insert slip
NB
Remove slip

REG 03-04-2003 13:30
C01 MC #01 001056
#000033
CHECK No. **1234**

Table No.

1 PLU0001	.10.00
1 PLU0001	.10.00
1 PLU0002	.20.00
1 PLU0002	.20.00
1 PLU0003	.30.00
+	.0.50
SRVC TL	- 90.50

New balance fee

Press <NEW BALANCE> to temporarily finalize the transaction. If you want to finalize a check immediately, use <CASH>, <CHARGE>, <CREDIT> or <CHECK>.

Adding to a check

Example

OPERATION		RECEIPT
Check#	1234	
Table#	33	
Item 1	Flat 1	\$30.00
	Quantity	1
Item 2	Flat 2	\$10.00
	Quantity	1

1 2 3 4 OLD CHECK
3 0 00 001
1 0 00 002
Insert slip
NB
Remove slip

REG 03-04-2003 13:35
C01 MC #01 001057
#000033
CHECK No. **1234**

ST	.90.50
1 PLU0001	.30.00
1 PLU0002	.10.00
+	.0.50
SRVC TL	- 131.00

- The table number is stored in the check tracking index memory so its input is not required in this operation even if table number input is preset as compulsory. Table number input after inputting the check number may be performed, however, without generating an error.
- Once a check is opened under a number in REG mode, the same mode must be used to make additions to the check.

Advanced Operations

Issuing a guest receipt

The following operation can be used to print out the balance of a temporarily finalized check.

Example

OPERATION	RECEIPT
<div style="display: flex; justify-content: space-around; align-items: center;"> <div style="border: 1px solid black; padding: 2px 5px; margin: 2px;">1</div> <div style="border: 1px solid black; padding: 2px 5px; margin: 2px;">2</div> <div style="border: 1px solid black; padding: 2px 5px; margin: 2px;">3</div> <div style="border: 1px solid black; padding: 2px 5px; margin: 2px;">4</div> <div style="border: 1px solid black; padding: 2px 5px; margin: 2px;">RECEIPT</div> </div> <p style="text-align: center;">Input the number of check you want.</p>	<pre> REG 03-04-2003 13:30 C01 MC #01 001056 #000033 CHECK No. 1234 1 PLU0001 -10.00 1 PLU0001 -10.00 1 PLU0002 -20.00 1 PLU0002 -20.00 1 PLU0003 -30.00 + + -0.50 1 PLU0001 -30.00 1 PLU0002 -10.00 + + -0.50 SRVC TL - 131.00 *** GUEST BOTTOM MESSAGE 1 ** *** GUEST BOTTOM MESSAGE 2 ** *** GUEST BOTTOM MESSAGE 3 ** : *** GUEST BOTTOM MESSAGE10 ** </pre>

Guest receipt message

Closing a check memory

Example

OPERATION	RECEIPT
<div style="display: flex; justify-content: space-around; align-items: center; margin-bottom: 10px;"> <div style="border: 1px solid black; padding: 2px 5px; margin: 2px;">1</div> <div style="border: 1px solid black; padding: 2px 5px; margin: 2px;">2</div> <div style="border: 1px solid black; padding: 2px 5px; margin: 2px;">3</div> <div style="border: 1px solid black; padding: 2px 5px; margin: 2px;">4</div> <div style="border: 1px solid black; padding: 2px 5px; margin: 2px;">OLD CHECK</div> </div> <p style="text-align: center;">Insert slip</p> <div style="display: flex; justify-content: space-around; align-items: center;"> <div style="border: 1px solid black; padding: 2px 5px; margin: 2px;">1</div> <div style="border: 1px solid black; padding: 2px 5px; margin: 2px;">5</div> <div style="border: 1px solid black; padding: 2px 5px; margin: 2px;">0</div> <div style="border: 1px solid black; padding: 2px 5px; margin: 2px;">00</div> <div style="border: 1px solid black; padding: 2px 5px; margin: 2px;">CA/AMT TEND</div> </div>	<pre> REG 03-04-2003 13:40 C01 MC #01 001058 #000033 CHECK No. 1234 ST -131.00 TL - 131.00 CASH -150.00 CG -19.00 </pre>

SLIP

REG C01	MC#01
03-04-2003 17:05	000150
CHECK No. 1234	1CT #000033
1 PLU0001	.10.00
1 PLU0001	.10.00
1 PLU0002	.20.00
1 PLU0002	.20.00
1 PLU0003	.30.00
+	.0.50
#11 SRVC TL	- 90.50
1 PLU0001	.30.00
1 PLU0002	.10.00
+	.0.50
#15 SRVC TL	- 131.00
TL	- 131.00
CASH	.150.00
CG	.19.00

New/old check key operation

Example 1

When a check number is input and <NEW/OLD> is pressed, the key works as a new check key function if there is no matching check number in the check tracking memory.

OPERATION

3
4
5
6
NEW/OLD
 Input a check number and press
 <NEW/OLD>.

1
0
00
001
2
0
00
002
NB

RECEIPT

REG C01	03-04-2003 13:50
MC #01	001060
CHECK No. 3456	
1 PLU0001	.10.00
1 PLU0002	.20.00
+	.0.50
SRVC TL	- 30.50

Example 2

When a check number is input and <NEW/OLD> is pressed, the key works as an old check key if there is matching check number in the check tracking memory.

OPERATION

3
4
5
6
NEW/OLD
3
1
00
CA/AMT/TEND

RECEIPT

REG C01	03-04-2003 13:55
MC #01	001061
CHECK No. 3456	
ST	.30.50
TL	- 30.50
CASH	.31.00
CG	.0.50

Advanced Operations

Add check

This operation lets you combine the amounts of more than one check into a single check.

Example

Registration for check number 1234

Original check			OPERATION	RECEIPT	
Check#	1234		<div style="display: flex; justify-content: space-around;"> 1234 </div> <div style="display: flex; justify-content: space-around;"> 33 </div> <div style="display: flex; justify-content: space-around;"> 1000 </div> <div style="display: flex; justify-content: space-around;"> 2000 </div>	<div style="display: flex; flex-direction: column; align-items: center;"> <div style="border: 1px solid black; padding: 2px; margin-bottom: 2px;">NEW CHECK</div> <div style="border: 1px solid black; padding: 2px; margin-bottom: 2px;">TABLE #</div> <div style="border: 1px solid black; padding: 2px; margin-bottom: 2px;">001</div> <div style="border: 1px solid black; padding: 2px; margin-bottom: 2px;">002</div> <div style="border: 1px solid black; padding: 2px;">NB</div> </div>	<pre> REG 03-04-2003 14:00 C01 MC #01 001062 #000033 CHECK No. 1234 1 PLU0001 ·10.00 1 PLU0002 ·20.00 + ·0.50 SRVC TL - 30.50 </pre>

Registration for check number 3456

Added check			OPERATION	RECEIPT	
Check#	3456		<div style="display: flex; justify-content: space-around;"> 3456 </div> <div style="display: flex; justify-content: space-around;"> 3000 </div>	<div style="display: flex; flex-direction: column; align-items: center;"> <div style="border: 1px solid black; padding: 2px; margin-bottom: 2px;">NEW CHECK</div> <div style="border: 1px solid black; padding: 2px; margin-bottom: 2px;">001</div> <div style="border: 1px solid black; padding: 2px;">NB</div> </div>	<pre> REG 03-04-2003 14:05 C01 MC #01 001063 CHECK No. 1234 1 PLU0001 ·30.00 + ·0.50 SRVC TL - 30.50 </pre>

Registration for check number 1234

Check No. : 1234		OPERATION	RECEIPT	
	<div style="border: 1px solid black; padding: 5px; margin-bottom: 5px;">Check No. : 3456</div> <div style="border: 1px dashed black; padding: 5px;">←</div>	<div style="display: flex; justify-content: space-around;"> 1234 </div> <div style="display: flex; justify-content: space-around;"> 3456 </div>	<div style="display: flex; flex-direction: column; align-items: center;"> <div style="border: 1px solid black; padding: 2px; margin-bottom: 2px;">OLD CHECK</div> <div style="border: 1px solid black; padding: 2px; margin-bottom: 2px;">ADD CHECK</div> <div style="border: 1px solid black; padding: 2px;">NB</div> </div>	<pre> REG 03-04-2003 14:10 C01 MC #01 001064 #000033 CHECK No. 1234 ST ·30.50 ADD CHK 3456 ST ·30.50 + ·0.50 SRVC TL - 61.50 </pre>

These lines are not printed on receipt.

Separate check

This operation makes it possible to split a single check into separate checks.

Example

Check# 1234		
Item 1	Flat 1	\$10.00
	Quantity	1
Item 2	Flat 2	\$20.00
	Quantity	1
Item 3	Flat 3	\$30.00
	Quantity	1
Item 4	Flat 4	\$40.00
	Quantity	1

Check# 3456		
Item 1	Flat 1	\$10.00
	Quantity	1
Item 2	Flat 3	\$30.00
	Quantity	1
Payment	Cash	\$40.00

OPERATION

RECEIPT

3 4 5 6 NEW CHECK

This input of a temporary check number can be skipped.

1 2 3 4 SEPARATE CHECK

Input the original check number by <SEP CHK>.

Display shows the contents of check No. 1234, so designate the 1st item which will be separated by ↑, ↓ key.

YES

After <YES>, this item is separated.

Designate the 3rd item which will be separated by ↑, ↓ key.

YES

ESC/ SKIP

Press <ESC>.

4 0 00 CA/AMT/TEND

REG	03-04-2003	14:15
C01	MC #01	001065
CHECK No. 3456		
1	PLU0001	.10.00
1	PLU0003	.30.00
	ST	-40.00
	CASH	.40.00
	CG	.0.00

Advanced Operations

Clerk transfer

This operation lets you change the clerk who is in charge of a specific open check number.

Example

To change the clerk for check number 1234 from clerk 1 to clerk 4.

OPERATION	RECEIPT																																
<p style="text-align: right; margin-right: 20px;">CLK#</p> <p>Press this key if you do not want the clerk No. or clerk secret No. to appear on the display.</p> <p style="text-align: right; margin-right: 20px;">1 CLK TRANS</p> <p>Input the clerk No. of the clerk who is currently in charge of check No. 1234 (target check).</p> <p style="text-align: right; margin-right: 20px;">4 OP#</p> <p>Input the clerk No. of the clerk who will take over check No. 1234 (target check).</p> <p style="text-align: right; margin-right: 20px;">1 2 3 4 NEW CHECK</p> <p>Input the target check No. that is transferred from clerk 1 to 4. You can use either <OLD CHK>, <NEW/OLD>. Note that if you skip this step, all check Nos currently assigned to clerk 1 are transferred to clerk 4.</p> <p style="text-align: right; margin-right: 20px;">CLK TRANS</p>	<table border="1" style="width: 100%; border-collapse: collapse;"> <tr> <td>REG</td> <td>03-04-2003</td> <td>14:20</td> <td></td> </tr> <tr> <td>C01</td> <td>MC #01</td> <td>001067</td> <td></td> </tr> <tr> <td colspan="4"> </td> </tr> <tr> <td>CLK TRANS</td> <td></td> <td></td> <td></td> </tr> <tr> <td>C01</td> <td>C04</td> <td></td> <td></td> </tr> <tr> <td>1234</td> <td></td> <td></td> <td style="text-align: right;">-60.50</td> </tr> <tr> <td colspan="3">-----</td> <td></td> </tr> <tr> <td>TL</td> <td></td> <td></td> <td style="text-align: right;">-60.50</td> </tr> </table> <p style="text-align: right; margin-right: 20px;">Check No./ NB amount</p>	REG	03-04-2003	14:20		C01	MC #01	001067						CLK TRANS				C01	C04			1234			-60.50	-----				TL			-60.50
REG	03-04-2003	14:20																															
C01	MC #01	001067																															
CLK TRANS																																	
C01	C04																																
1234			-60.50																														

TL			-60.50																														

Table transfer

With this operation, you can change the number of a check.

Example 1

To change the check number 1234 to 1111 (which is newly opened).

Check No:
1234

1111 <TBL TRN>

Check No:
1234

Check No:
1111

OPERATION	RECEIPT																																
<p style="text-align: right; margin-right: 20px;">1 2 3 4 NEW CHECK</p> <p style="text-align: right; margin-right: 20px;">1 0 00 001</p> <p style="text-align: right; margin-right: 20px;">1 1 1 1 TABLE TRANS</p> <p>Input the new check No.</p>	<table border="1" style="width: 100%; border-collapse: collapse;"> <tr> <td>REG</td> <td>03-04-2003</td> <td>14:25</td> <td></td> </tr> <tr> <td>C01</td> <td>MC #01</td> <td>001068</td> <td></td> </tr> <tr> <td colspan="4">CHECK No. 1234</td> </tr> <tr> <td>1 PLU0001</td> <td></td> <td></td> <td style="text-align: right;">-10.00</td> </tr> <tr> <td>Check No.</td> <td></td> <td></td> <td style="text-align: right;">1234</td> </tr> <tr> <td>ST</td> <td></td> <td></td> <td style="text-align: right;">-10.00</td> </tr> <tr> <td>TBL TRANS</td> <td></td> <td></td> <td style="text-align: right;">1111</td> </tr> <tr> <td>SRVC TL</td> <td></td> <td></td> <td style="text-align: right;">- 10.00</td> </tr> </table>	REG	03-04-2003	14:25		C01	MC #01	001068		CHECK No. 1234				1 PLU0001			-10.00	Check No.			1234	ST			-10.00	TBL TRANS			1111	SRVC TL			- 10.00
REG	03-04-2003	14:25																															
C01	MC #01	001068																															
CHECK No. 1234																																	
1 PLU0001			-10.00																														
Check No.			1234																														
ST			-10.00																														
TBL TRANS			1111																														
SRVC TL			- 10.00																														

Example 2

To change the check number 3456 to 2222 (which has already been opened).

Check No:
3456

Check No:
2222

2222 <TBL TRN>

Check No:
3456

Check No:
2222

Added

OPERATION	RECEIPT																																				
<p style="text-align: right; margin-right: 20px;">3 4 5 6 OLD CHECK</p> <p style="text-align: right; margin-right: 20px;">1 0 00 001</p> <p style="text-align: right; margin-right: 20px;">2 2 2 2 TABLE TRANS</p>	<table border="1" style="width: 100%; border-collapse: collapse;"> <tr> <td>REG</td> <td>03-04-2003</td> <td>14:30</td> <td></td> </tr> <tr> <td>C01</td> <td>MC #01</td> <td>001069</td> <td></td> </tr> <tr> <td colspan="4">CHECK No. 3456</td> </tr> <tr> <td>ST</td> <td></td> <td></td> <td style="text-align: right;">-10.00</td> </tr> <tr> <td>1 PLU0001</td> <td></td> <td></td> <td style="text-align: right;">-10.00</td> </tr> <tr> <td>Check No.</td> <td></td> <td></td> <td style="text-align: right;">3456</td> </tr> <tr> <td>ST</td> <td></td> <td></td> <td style="text-align: right;">-20.00</td> </tr> <tr> <td>TBL TRANS</td> <td></td> <td></td> <td style="text-align: right;">2222</td> </tr> <tr> <td>SRVC TL</td> <td></td> <td></td> <td style="text-align: right;">- 30.00</td> </tr> </table>	REG	03-04-2003	14:30		C01	MC #01	001069		CHECK No. 3456				ST			-10.00	1 PLU0001			-10.00	Check No.			3456	ST			-20.00	TBL TRANS			2222	SRVC TL			- 30.00
REG	03-04-2003	14:30																																			
C01	MC #01	001069																																			
CHECK No. 3456																																					
ST			-10.00																																		
1 PLU0001			-10.00																																		
Check No.			3456																																		
ST			-20.00																																		
TBL TRANS			2222																																		
SRVC TL			- 30.00																																		

Condiment/preparation PLUs

You can force entering condiment or preparation PLU after the main PLU registration by programming.

Example (condiment PLU)

OPERATION			RECEIPT
Main item	Flat 1	\$10.00	REG 03-04-2003 14:50 C01 MC #01 001080 1 PLU0001 -10.00 1 PLU0106 -0.10 1 PLU0012 -0.20 1 PLU0013 -0.30 TL -10.60 CASH -10.60
	Flat 106	\$0.10	
Condiment	PLU 12	\$0.20	
	PLU 13	\$0.30	
Payment	Cash	\$10.60	

001

Registering main PLU.
No condiment registration occurs an error condition.

106

PLU

1

2

PLU

1

3

PLU

CA/AMT
TEND

Example (preparation PLU)

OPERATION			RECEIPT
Main item	Flat 2	\$20.00	REG 03-04-2003 14:55 C01 MC #01 001081 1 PLU0002 -20.00 1 PLU0004 1 PLU0022 1 PLU0023 TL -20.00 CASH -20.00
	Flat 4	\$0.00	
Preparation	PLU 22	\$0.00	
	PLU 23	\$0.00	
Payment	Cash	\$20.00	

002

Registering main PLU.

004

PLU

2

2

PLU

2

3

PLU

CA/AMT
TEND

Text recall

This procedure is used to recall text by inputting the address where the text is stored. The recalled text is printed on the receipt and journal. You can also choose recall texts by text recall sub window, which is shown by pressing <TEXT RECALL> directly.

Example

OPERATION			RECEIPT
Item 1	Flat 1	\$46.00	REG 03-04-2003 15:00 C01 MC #01 001082 1 PLU0001 -46.00 MEDIUM SIZE 1 PLU0002 -10.00 SMALL SIZE TL -56.00 CASH -56.00
	Quantity	1	
Item 2	Flat 2	\$10.00	
	Quantity	1	
Payment	Cash	\$56.00	
Text 1	MEDIUM SIZE		
Text 2	SMALL SIZE		

4 6 00 001

1 TEXT RECALL

1 0 00 002

2 TEXT RECALL

SUB TOTAL

CA/AMT TEND

Advanced Operations

Deposit registrations

Use the following procedures to register deposits.

Deposit from customer

	OPERATION	RECEIPT																					
<table border="1" style="width: 100%; border-collapse: collapse;"> <tr> <td style="width: 33%;">Deposit</td> <td style="width: 33%;">Cash</td> <td style="width: 33%; text-align: right;">\$50.00</td> </tr> </table>	Deposit	Cash	\$50.00	<div style="display: flex; align-items: center; justify-content: center;"> <div style="margin-right: 10px;">5 0 00</div> <div style="border: 1px solid black; padding: 2px;">DEPOSIT -</div> </div> <div style="margin-top: 10px; text-align: center;"> <div style="border: 1px solid black; padding: 2px; display: inline-block;">CA/AMT TEND</div> </div>	<table style="width: 100%; border-collapse: collapse;"> <tr> <td>REG</td> <td>03-04-2003</td> <td>15:05</td> </tr> <tr> <td>C01</td> <td>MC #01</td> <td>001083</td> </tr> <tr> <td colspan="3"> </td> </tr> <tr> <td>DEPO-</td> <td></td> <td style="text-align: right;">.50.00</td> </tr> <tr> <td>TL</td> <td></td> <td style="text-align: right;">- 50.00</td> </tr> <tr> <td>CASH</td> <td></td> <td style="text-align: right;">.50.00</td> </tr> </table>	REG	03-04-2003	15:05	C01	MC #01	001083				DEPO-		.50.00	TL		- 50.00	CASH		.50.00
Deposit	Cash	\$50.00																					
REG	03-04-2003	15:05																					
C01	MC #01	001083																					
DEPO-		.50.00																					
TL		- 50.00																					
CASH		.50.00																					

Deposit from customer during sales transaction

	OPERATION	RECEIPT																																				
<table border="1" style="width: 100%; border-collapse: collapse;"> <tr> <td style="width: 33%;">Items</td> <td style="width: 33%;">Flat 1</td> <td style="width: 33%; text-align: right;">\$10.00</td> </tr> <tr> <td></td> <td>Flat 2</td> <td style="text-align: right;">\$20.00</td> </tr> <tr> <td>Deposit</td> <td></td> <td style="text-align: right;">\$20.00</td> </tr> <tr> <td>Payment</td> <td>Cash</td> <td style="text-align: right;">\$10.00</td> </tr> </table>	Items	Flat 1	\$10.00		Flat 2	\$20.00	Deposit		\$20.00	Payment	Cash	\$10.00	<div style="display: flex; align-items: center; justify-content: center;"> <div style="margin-right: 10px;">1 0 00</div> <div style="border: 1px solid black; padding: 2px;">001</div> </div> <div style="margin-top: 10px; text-align: center;"> <div style="display: flex; align-items: center; justify-content: center;"> <div style="margin-right: 10px;">2 0 00</div> <div style="border: 1px solid black; padding: 2px;">002</div> </div> <div style="margin-top: 10px;"> <div style="display: flex; align-items: center; justify-content: center;"> <div style="margin-right: 10px;">2 0 00</div> <div style="border: 1px solid black; padding: 2px;">DEPOSIT +</div> </div> <div style="margin-top: 10px; text-align: center;"> <div style="border: 1px solid black; padding: 2px; display: inline-block;">CA/AMT TEND</div> </div> </div> </div>	<table style="width: 100%; border-collapse: collapse;"> <tr> <td>REG</td> <td>03-04-2003</td> <td>15:10</td> </tr> <tr> <td>C01</td> <td>MC #01</td> <td>001084</td> </tr> <tr> <td colspan="3"> </td> </tr> <tr> <td>1 PLU0001</td> <td></td> <td style="text-align: right;">.10.00</td> </tr> <tr> <td>1 PLU0002</td> <td></td> <td style="text-align: right;">.20.00</td> </tr> <tr> <td>DEPO+</td> <td></td> <td style="text-align: right;">-20.00</td> </tr> <tr> <td>TL</td> <td></td> <td style="text-align: right;">- 10.00</td> </tr> <tr> <td>CASH</td> <td></td> <td style="text-align: right;">.10.00</td> </tr> </table>	REG	03-04-2003	15:10	C01	MC #01	001084				1 PLU0001		.10.00	1 PLU0002		.20.00	DEPO+		-20.00	TL		- 10.00	CASH		.10.00
Items	Flat 1	\$10.00																																				
	Flat 2	\$20.00																																				
Deposit		\$20.00																																				
Payment	Cash	\$10.00																																				
REG	03-04-2003	15:10																																				
C01	MC #01	001084																																				
1 PLU0001		.10.00																																				
1 PLU0002		.20.00																																				
DEPO+		-20.00																																				
TL		- 10.00																																				
CASH		.10.00																																				

• You can select “DEPO+” or “DEPO-” by programming.

List-# registrations

By using <LIST-#>, you can register an item by selecting candidates in the “LIST” window.

Example

	OPERATION	DISPLAY																																																	
<table border="1" style="width: 100%; border-collapse: collapse;"> <tr> <td colspan="3" style="text-align: center;">List-10</td> </tr> <tr> <td style="width: 33%;">1. PLU0010</td> <td style="width: 33%;"></td> <td style="width: 33%; text-align: right;">\$1.00</td> </tr> <tr> <td>2. PLU0012</td> <td></td> <td style="text-align: right;">\$2.00</td> </tr> <tr> <td>3. PLU0015</td> <td></td> <td style="text-align: right;">\$5.00</td> </tr> <tr> <td>4. PLU0100</td> <td></td> <td style="text-align: right;">\$1.25</td> </tr> <tr> <td>5. PLU0111</td> <td></td> <td style="text-align: right;">\$12.98</td> </tr> </table>	List-10			1. PLU0010		\$1.00	2. PLU0012		\$2.00	3. PLU0015		\$5.00	4. PLU0100		\$1.25	5. PLU0111		\$12.98	<div style="display: flex; align-items: center; justify-content: center;"> <div style="margin-right: 10px;">1 0</div> <div style="border: 1px solid black; padding: 2px;">LIST#</div> </div> <div style="margin-top: 10px; text-align: center;"> <div style="margin-bottom: 10px;">↓</div> <div style="margin-bottom: 10px;">↓</div> <div style="border: 1px solid black; padding: 2px; display: inline-block;">YES</div> </div> <div style="margin-top: 10px; text-align: center;"> <div style="display: flex; align-items: center; justify-content: center;"> <div style="margin-right: 10px;">(or 3)</div> <div style="border: 1px solid black; padding: 2px;">YES</div> </div> </div> <div style="margin-top: 10px; text-align: center;"> <div style="border: 1px solid black; padding: 2px; display: inline-block;">CA/AMT TEND</div> </div>	<table style="width: 100%; border-collapse: collapse;"> <tr> <td>REG C01</td> <td>03-04-03</td> <td>15:11</td> <td>001085</td> </tr> <tr> <td colspan="4" style="text-align: center;">LIST10</td> </tr> <tr> <td colspan="4" style="border: 1px solid black; padding: 2px;"> <table style="width: 100%; border-collapse: collapse;"> <tr> <td>1. PLU0010</td> <td></td> <td></td> </tr> <tr> <td>2. PLU0012</td> <td></td> <td></td> </tr> <tr style="background-color: #e0e0e0;"> <td>3. PLU0015</td> <td></td> <td></td> </tr> <tr> <td>4. PLU0100</td> <td></td> <td></td> </tr> <tr> <td>5. PLU0111</td> <td></td> <td></td> </tr> </table> </td> </tr> <tr> <td colspan="3"></td> <td style="text-align: right;">• 0.00</td> </tr> </table>	REG C01	03-04-03	15:11	001085	LIST10				<table style="width: 100%; border-collapse: collapse;"> <tr> <td>1. PLU0010</td> <td></td> <td></td> </tr> <tr> <td>2. PLU0012</td> <td></td> <td></td> </tr> <tr style="background-color: #e0e0e0;"> <td>3. PLU0015</td> <td></td> <td></td> </tr> <tr> <td>4. PLU0100</td> <td></td> <td></td> </tr> <tr> <td>5. PLU0111</td> <td></td> <td></td> </tr> </table>				1. PLU0010			2. PLU0012			3. PLU0015			4. PLU0100			5. PLU0111						• 0.00
List-10																																																			
1. PLU0010		\$1.00																																																	
2. PLU0012		\$2.00																																																	
3. PLU0015		\$5.00																																																	
4. PLU0100		\$1.25																																																	
5. PLU0111		\$12.98																																																	
REG C01	03-04-03	15:11	001085																																																
LIST10																																																			
<table style="width: 100%; border-collapse: collapse;"> <tr> <td>1. PLU0010</td> <td></td> <td></td> </tr> <tr> <td>2. PLU0012</td> <td></td> <td></td> </tr> <tr style="background-color: #e0e0e0;"> <td>3. PLU0015</td> <td></td> <td></td> </tr> <tr> <td>4. PLU0100</td> <td></td> <td></td> </tr> <tr> <td>5. PLU0111</td> <td></td> <td></td> </tr> </table>				1. PLU0010			2. PLU0012			3. PLU0015			4. PLU0100			5. PLU0111																																			
1. PLU0010																																																			
2. PLU0012																																																			
3. PLU0015																																																			
4. PLU0100																																																			
5. PLU0111																																																			
			• 0.00																																																
<table border="1" style="width: 100%; border-collapse: collapse;"> <tr> <td style="width: 33%;">Item</td> <td style="width: 33%;">PLU0015</td> <td style="width: 33%; text-align: right;">\$5.00</td> </tr> <tr> <td></td> <td>Quantity</td> <td style="text-align: center;">1</td> </tr> <tr> <td>Payment</td> <td>Cash</td> <td style="text-align: right;">\$5.00</td> </tr> </table>	Item	PLU0015	\$5.00		Quantity	1	Payment	Cash	\$5.00		<table style="width: 100%; border-collapse: collapse;"> <tr> <td>REG</td> <td>03-04-2003</td> <td>15:15</td> </tr> <tr> <td>C01</td> <td>MC #01</td> <td>001085</td> </tr> <tr> <td colspan="3"> </td> </tr> <tr> <td>1 PLU0015</td> <td></td> <td style="text-align: right;">.5.00</td> </tr> <tr> <td>TL</td> <td></td> <td style="text-align: right;">- 5.00</td> </tr> <tr> <td>CASH</td> <td></td> <td style="text-align: right;">.5.00</td> </tr> </table>	REG	03-04-2003	15:15	C01	MC #01	001085				1 PLU0015		.5.00	TL		- 5.00	CASH		.5.00																						
Item	PLU0015	\$5.00																																																	
	Quantity	1																																																	
Payment	Cash	\$5.00																																																	
REG	03-04-2003	15:15																																																	
C01	MC #01	001085																																																	
1 PLU0015		.5.00																																																	
TL		- 5.00																																																	
CASH		.5.00																																																	

Bill copy

Example

To issue a copy of a bill dated February 1, 2003 in the amount of \$35.00 cash.

OPERATION	RECEIPT
<div style="display: flex; justify-content: space-around; align-items: center;"> <div style="text-align: center;"> <div style="display: flex; justify-content: center; gap: 5px;"> 0 2 0 1 2 0 0 3 </div> <p style="font-size: small; margin-top: 5px;">Enter date by date order.</p> </div> <div style="border: 1px solid black; padding: 2px; font-size: x-small; text-align: center;">BILL COPY</div> </div> <div style="display: flex; justify-content: space-around; align-items: center; margin-top: 20px;"> <div style="text-align: center;"> <div style="display: flex; justify-content: center; gap: 5px;"> 3 5 00 </div> </div> <div style="border: 1px solid black; padding: 2px; font-size: x-small; text-align: center;">CA/AMT /TEND</div> </div>	<div style="border: 1px solid black; padding: 5px; font-family: monospace; font-size: small;"> <pre> **** BILL TOP MESSAGE 1 **** **** BILL TOP MESSAGE 2 **** **** BILL TOP MESSAGE 3 **** **** BILL TOP MESSAGE 4 **** REG 02-01-2003 C01 MC#01 **** BILL COPY MESSAGE 1 **** **** BILL COPY MESSAGE 2 **** **** BILL COPY MESSAGE 3 **** **** BILL COPY MESSAGE 4 **** TA1 .35.00 TX1 .3.50 TL - 38.50 CASH .38.50 **** BILL BTM MESSAGE 1 **** **** BILL BTM MESSAGE 2 **** **** BILL BTM MESSAGE 3 **** **** BILL BTM MESSAGE 4 **** </pre> </div> <div style="margin-top: 5px;"> <p>Bill top message *¹</p> <p>Bill copy message *¹</p> <p>Add-on tax amount</p> <p>Bill bottom message *¹</p> <p>*¹ Programmable option</p> </div>

Note that you can finalize this operation using the cash amount tendered key.

Tray total

Multiple item totalling function

This function accumulates all items registered from the first item registered up to point that <TRAY TOTAL> is pressed two times, or all items between two presses of <TRAY TOTAL> . Pressing <TRAY TOTAL> two times displays the total amount with the tax included and prints it on the receipt and journal (printing on receipt and journal is programmable.)

Example

OPERATION			RECEIPT			
CustomerA	Flat 1	\$1.00	1	00	001	REG 03-04-2003 15:20 C01 MC #01 001086 1 PLU0001 .1.00 1 PLU0003 .2.00 TRAY TL - 3.00 1 PLU0003 .3.00 1 PLU0004 .4.00 TRAY TL - 7.00 TL - 10.00 CASH .10.00
	Flat 3	\$2.00	2	00	003	
CustomerB	Flat 3	\$3.00				
	Flat 4	\$4.00	3	00	003	
Payment	Cash	\$10.00	4	00	004	
			TRAY TOTAL	TRAY TOTAL		
			TRAY TOTAL	TRAY TOTAL		
			CA/AMT	TEND		

Set menu

When you register a set menu, the unit price of the parent PLU is used. The price of each set menu item is also added to each respective PLU totalizer and counter.

Example

OPERATION			RECEIPT		
Set menu	Flat 4	\$5.00	<div style="border: 1px solid black; padding: 5px; display: inline-block;">004</div> <div style="border: 1px solid black; padding: 5px; display: inline-block;">CA / AMT / TEND</div>	<div style="border: 1px solid black; padding: 5px;"> REG 03-04-2003 15:25 C01 MC #01 001087 1 PLU0004 .5.00 PLU0031 PLU0032 PLU0033 PLU0034 TL - 5.00 CASH .5.00 </div>	
Item 1	PLU 31	\$2.00			
Item 2	PLU 32	\$2.00			
Item 3	PLU 33	\$1.00			
Item 4	PLU 34	\$1.00			
Payment	Cash	\$5.00			

Tips

Example

OPERATION			RECEIPT		
Item 1	Flat 1	\$3.00	<div style="border: 1px solid black; padding: 5px; display: inline-block;">3 00 001</div> <div style="border: 1px solid black; padding: 5px; display: inline-block;">5 00 002</div> <div style="border: 1px solid black; padding: 5px; display: inline-block;">SUB TOTAL</div> <div style="border: 1px solid black; padding: 5px; display: inline-block;">8 0 TIP</div> <div style="border: 1px solid black; padding: 5px; display: inline-block;">1 0 00 CA / AMT / TEND</div>	<div style="border: 1px solid black; padding: 5px;"> REG 03-04-2003 15:30 C01 MC #01 001088 1 PLU0001 .3.00 1 PLU0002 .5.00 TIP .0.80 TL - 8.80 CASH .10.00 CG .1.20 </div>	
	Quantity	1			
Item 2	Flat 2	\$5.00			
	Quantity	1			
Tip	Amount	\$0.80			
Payment	Cash	\$10.00			

Stock check

Each PLU has an actual stock totalizer that you can program with a minimum stock quantity. The register checks actual stock quantities against the programmed minimum stock quantities. Stock operations are performed only for PLUs programmed with minimum stock quantities.

Stock warnings

When the minimum stock value of an item is set, the register subtracts its stock quantity from the registered quantity (or registered quantity * unit stock).

The following warning indicates stock problem to the operator.

- **Negative stock:**
This indicates that the actual stock quantity is negative. The cash register to treat this condition as an error.
- **Under minimum stock:**
This indicates that the actual stock quantity is less than the minimum stock quantity. The cash register sounds buzzer when the actual stock quantity is less than the minimum stock quantity.

Notes

- None of the warning indicators appear unless the cash register is specifically programmed for the stock check operation.
- Stock operations can be performed for registrations in the REF mode or those performed with <REFUND> (the refund key).
- An error correct, void, or cancel operation restores the original value of items back in stock value. (You can change the stock calculation formula of REF mode, <REFUND> or <VOID> by programming.)

Actual stock quantity inquiry

With this operation, you can recall the actual stock quantity for PLUs and show it on the display of the cash register.

Example

To inquire the actual stock quantity of flat-PLU 001.

OPERATION

DISPLAY

STOCK
INQ
001

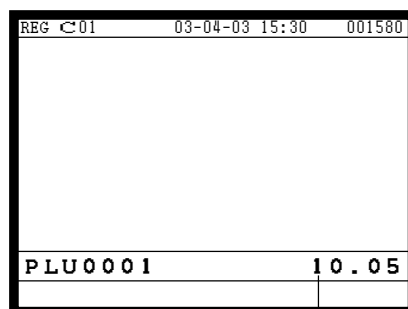

Actual stock quantity

Single item cash sales

A department key, subdepartment or PLU programmed with single item sale status finalizes the transaction as soon as it is registered.

The single item sales function cannot work properly if the keyboard does not include <CASH> (the cash key). The single item sales function can only be used for cash sales.

Example 1

OPERATION				RECEIPT		
Item	Flat 1	\$1.00	<div style="display: flex; justify-content: center; gap: 10px;"> 1 00 001 </div> <p>The transaction is immediately finalized.</p>		REG	03-04-2003 15:35
	Quantity	1			C01	MC #01 001089
	Status	S.I.S			1 PLU0001	.1.00
Payment	Cash	\$1.00		TL	- 1.00	
				CASH	.1.00	

Example 2

OPERATION				RECEIPT		
Item	Flat 1	(\$1.00)	<div style="display: flex; justify-content: center; gap: 10px;"> 3 X </div> <div style="display: flex; justify-content: center; gap: 10px; margin-top: 5px;"> 001 </div> <p>The transaction is immediately finalized.</p>		REG	03-04-2003 15:40
	Quantity	3			C01	MC #01 001090
	Status	S.I.S			3 PLU0001	.3.00
Payment	Cash	\$3.00		TL	- 3.00	
				CASH	.3.00	

Example 3

OPERATION				RECEIPT		
Item 1	Flat 4	\$2.00	<div style="display: flex; justify-content: center; gap: 10px;"> 2 00 004 </div> <div style="display: flex; justify-content: center; gap: 10px; margin-top: 5px;"> 001 </div> <p>The transaction is not finalized. Because another item is registered before the single item sales.</p>		REG	03-04-2003 15:40
	Quantity	1			C01	MC #01 001090
	Status	Normal			1 PLU0004	.2.00
Item 2	Flat 1	\$1.00		1 PLU0001	.1.00	
	Quantity	1		TL	- 3.00	
	Status	S.I.S		CASH	.3.00	
Payment	Cash	\$3.00	<div style="border: 1px solid black; padding: 2px 5px; display: inline-block;">CA/AMT /TEND</div>			

Advanced Operations

Addition

Addition (plus)

Example

Item 1	Flat 1	\$1.00
	Quantity	1
	Addition	\$0.10
Item 2	Flat 1	\$2.00
	Quantity	3
	Addition	3 × (\$0.20)
Payment	Cash	\$7.70

OPERATION

1 00 001
 1 0 +
 3 X
 2 00 001
 3 X
 +
 CA/AMT
 TEND

RECEIPT

REG	03-04-2003	15:50
C01	MC #01	001100
1 PLU0001		·1.00
+		·0.10
3 PLU0001		·6.00
+		·0.60
TL		-7.70
CASH		·7.70

Premium (%+)

Example

Item 1	Flat 1	\$1.00
	Quantity	1
	Premium	10%
Item 2	Flat 1	\$2.00
	Quantity	3
Subtotal	Premium	(15%)
Payment	Cash	\$8.17

OPERATION

1 00 001
 1 0 %+
 3 X
 2 00 001
 SUB
 TOTAL
 %+
 CA/AMT
 TEND

RECEIPT

REG	03-04-2003	15:50
C01	MC #01	001100
1 PLU0001		·1.00
10%		
%+		·0.10
3 PLU0001		·6.00
ST		·7.10
15%		
%+		·1.07
TL		-8.17
CASH		·8.17

Coupon transactions

Note that error occurs when the result of the coupon (not coupon 2) registration is negative, if the cash register is programmed to prohibit credit balances.

Coupon registration using <COUPON> (coupon key)

Example

			OPERATION	RECEIPT
Item 1	Flat 1	\$3.00	2 X 3 00 001 2 X 5 0 CPN 4 00 003 CPN CA/AMT TEND	<pre> REG 03-04-2003 16:00 C01 MC #01 001110 2 PLU0001 .6.00 COUPON -1.00 1 PLU0003 .4.00 COUPON -1.00 TL - 8.00 CASH .8.00 </pre>
	Quantity	2		
	Coupon	\$0.50 × 2		
Item 2	Flat 3	\$4.00		
	Quantity	1		
	Coupon	(\$1.00)		
Payment	Cash	\$8.00		

Coupon registration using <CPN2> (coupon 2 key)

Example

			OPERATION	RECEIPT
Item 1	Flat 1	\$15.00	CPN2 1 5 00 001 1 5 0 001 5 00 002 CPN2 5 0 002 CA/AMT TEND	<pre> REG 03-04-2003 16:05 C01 MC #01 001111 1 PLU0001 .15.00 CPN2 1 PLU0001 -1.50 1 PLU0002 .5.00 CPN2 1 PLU0002 -0.50 TL -18.00 CASH .18.00 </pre>
	Quantity	1		
	Coupon 2 Flat 1	\$1.50		
Item 2	Flat 2	\$5.00		
	Quantity	1		
	Coupon 2 Flat 2	(\$0.50)		
Payment	Cash	\$18.00		

Registering the second unit price

Second unit prices along with quantity modifiers can be programmed to PLUs. Pressing <1st@> (1st unit price key)/<2nd@> (2nd unit price key) calls up the first/second unit price, quantity modifier, and descriptor.

Totalizers and inventory are adjusted by multiplying the number of items being registered by the quantity modifier programmed to the PLU being registered.

- <1st@> or <2nd@> must be pressed before each registration of a PLU.
- Second unit price registration is not available with open PLUs when unit price is not preset.
- Second unit prices and quantity modifiers are assigned to PLUs using programming procedures described in the programming manual.

Example 1

	OPERATION	RECEIPT																																										
<table border="1" style="width: 100%; border-collapse: collapse;"> <tr> <td style="width: 15%;">Item 1</td> <td style="width: 15%;">Flat 1_{2nd@}</td> <td style="width: 15%;">(\$10.00)</td> </tr> <tr> <td></td> <td>Quantity</td> <td style="text-align: center;">1</td> </tr> <tr> <td></td> <td>2nd Q'ty</td> <td style="text-align: center;">1</td> </tr> <tr> <td style="vertical-align: top;">Item 2</td> <td>PLU 10_{2nd@}</td> <td style="text-align: center;">(\$5.00)</td> </tr> <tr> <td></td> <td>Quantity</td> <td style="text-align: center;">1</td> </tr> <tr> <td></td> <td>2nd Q'ty</td> <td style="text-align: center;">1</td> </tr> <tr> <td>Payment</td> <td>Cash</td> <td style="text-align: center;">\$15.00</td> </tr> </table>	Item 1	Flat 1 _{2nd@}	(\$10.00)		Quantity	1		2nd Q'ty	1	Item 2	PLU 10 _{2nd@}	(\$5.00)		Quantity	1		2nd Q'ty	1	Payment	Cash	\$15.00	<div style="display: flex; justify-content: center; gap: 10px;"> 2nd@ 001 </div> <p>The operation declares that the next input is a second unit price.</p> <div style="display: flex; justify-content: center; gap: 10px;"> 2nd@ 1 0 PLU </div> <div style="display: flex; justify-content: center; gap: 10px; margin-top: 10px;"> SUB TOTAL </div> <div style="display: flex; justify-content: center; gap: 10px; margin-top: 10px;"> CA/AMT /TEND </div>	<table border="1" style="width: 100%; border-collapse: collapse;"> <tr> <td style="width: 15%;">REG</td> <td style="width: 15%;">03-04-2003</td> <td style="width: 15%;">16:10</td> <td style="width: 15%;"></td> </tr> <tr> <td>C01</td> <td>MC #01</td> <td>001112</td> <td></td> </tr> <tr> <td>1</td> <td>PLU0001</td> <td style="text-align: right;">.10.00</td> <td rowspan="4" style="vertical-align: middle; padding-left: 10px;">2nd@ descriptor/ amount</td> </tr> <tr> <td>1</td> <td>PLU0010</td> <td style="text-align: right;">.5.00</td> </tr> <tr> <td></td> <td>TL</td> <td style="text-align: right;">- 15.00</td> </tr> <tr> <td></td> <td>CASH</td> <td style="text-align: right;">.15.00</td> </tr> </table>	REG	03-04-2003	16:10		C01	MC #01	001112		1	PLU0001	.10.00	2nd@ descriptor/ amount	1	PLU0010	.5.00		TL	- 15.00		CASH	.15.00
Item 1	Flat 1 _{2nd@}	(\$10.00)																																										
	Quantity	1																																										
	2nd Q'ty	1																																										
Item 2	PLU 10 _{2nd@}	(\$5.00)																																										
	Quantity	1																																										
	2nd Q'ty	1																																										
Payment	Cash	\$15.00																																										
REG	03-04-2003	16:10																																										
C01	MC #01	001112																																										
1	PLU0001	.10.00	2nd@ descriptor/ amount																																									
1	PLU0010	.5.00																																										
	TL	- 15.00																																										
	CASH	.15.00																																										

Example 2

	OPERATION	RECEIPT																																				
<table border="1" style="width: 100%; border-collapse: collapse;"> <tr> <td style="width: 15%;">Item</td> <td style="width: 15%;">Flat 2_{2nd@}</td> <td style="width: 15%;">(\$10.00)</td> </tr> <tr> <td></td> <td>Quantity</td> <td style="text-align: center;">5</td> </tr> <tr> <td></td> <td>2nd Q'ty</td> <td style="text-align: center;">3</td> </tr> <tr> <td>Payment</td> <td>Cash</td> <td style="text-align: center;">\$50.00</td> </tr> </table>	Item	Flat 2 _{2nd@}	(\$10.00)		Quantity	5		2nd Q'ty	3	Payment	Cash	\$50.00	<div style="display: flex; justify-content: center; gap: 10px;"> 5 X </div> <div style="display: flex; justify-content: center; gap: 10px; margin-top: 10px;"> 2nd@ 002 </div> <div style="display: flex; justify-content: center; gap: 10px; margin-top: 10px;"> 5 0 00 CA/AMT /TEND </div>	<table border="1" style="width: 100%; border-collapse: collapse;"> <tr> <td style="width: 15%;">REG</td> <td style="width: 15%;">03-04-2003</td> <td style="width: 15%;">16:15</td> <td style="width: 15%;"></td> </tr> <tr> <td>C01</td> <td>MC #01</td> <td>001113</td> <td></td> </tr> <tr> <td>5</td> <td>PLU0002</td> <td style="text-align: right;">.50.00</td> <td></td> </tr> <tr> <td></td> <td>TL</td> <td style="text-align: right;">- 50.00</td> <td></td> </tr> <tr> <td></td> <td>CASH</td> <td style="text-align: right;">.50.00</td> <td></td> </tr> <tr> <td></td> <td>CG</td> <td style="text-align: right;">.0.00</td> <td></td> </tr> </table>	REG	03-04-2003	16:15		C01	MC #01	001113		5	PLU0002	.50.00			TL	- 50.00			CASH	.50.00			CG	.0.00	
Item	Flat 2 _{2nd@}	(\$10.00)																																				
	Quantity	5																																				
	2nd Q'ty	3																																				
Payment	Cash	\$50.00																																				
REG	03-04-2003	16:15																																				
C01	MC #01	001113																																				
5	PLU0002	.50.00																																				
	TL	- 50.00																																				
	CASH	.50.00																																				
	CG	.0.00																																				

Example 3

The procedure shown on the previous page applies when the cash register is programmed not to maintain the 1st/2nd price shift. When the cash register is programmed to maintain the 1st/2nd price shift, the procedure below applies.

OPERATION

RECEIPT

Item 1	Flat 1 _{2nd@}	(\$10.00)
	Quantity	1
	2nd Q'ty	1
Item 2	Flat 2 _{2nd@}	(\$5.00)
	Quantity	1
	2nd Q'ty	1
Item 3	Flat 1	(\$1.00)
	Quantity	1
	2nd Q'ty	1
Payment	Cash	\$16.00

2nd@ 001
This operation shifts to registration of second unit price.

002
1st@ 001
This operation shifts to registration of normal (first) unit price.

1 6 00 CA/AMT /TEND

REG	03-04-2003	16:20
C01	MC #01	001114
1 PLU0001		.10.00
1 PLU0002		.5.00
1 PLU0001		.1.00
TL		- 16.00
CASH		.16.00
CG		.0.00

Preset tender amount

An amount up to six digits long can be programmed to <CASH> (cash/amount tendered key). Then, when <CASH> is pressed without inputting a value, the programmed value is automatically registered and the transaction is finalized. When an amount is programmed to <CASH>, attempting to manually input an amount results in an error.

Example 1

OPERATION			RECEIPT		
Item	Flat 1	\$8.00	8 00 001 CA/AMT /TEND	REG 03-04-2003 16:30 C01 MC #01 001120 1 PLU0001 .8.00 TL - 8.00 CASH .10.00 CG .2.00	
	Quantity	1			
Payment	Cash	(\$10.00)	The preset amount is tendered.		

Example 2

OPERATION			RECEIPT		
Item	Flat 1	\$15.00	1 5 00 001 1 0 00 CA/AMT /TEND (C) 5 00 CHK/ /TEND CA/AMT /TEND	REG 03-04-2003 16:35 C01 MC #01 001121 1 PLU0001 .15.00 TL - 15.00 CHECK .5.00 CASH .10.00 CG .0.00	
	Quantity	1			
Payment	Check	\$5.00	An error occurs by manual input		
	Cash	(\$10.00)			

Arrangement key registrations

Key (job/command) operations can be assigned to an <ARRANGE> (arrangement key). Then, simply pressing <ARRANGE> performs all of the key functions assigned to it.

Example

OPERATION			RECEIPT
Arrangement 1			<div style="border: 1px solid black; padding: 5px; width: fit-content;"> <div style="border: 1px solid black; display: inline-block; padding: 2px;">ARR</div> <pre> REG 03-04-2003 16:45 C01 MC #01 001130 1 PLU0010 -8.00 1 PLU0020 -5.00 TL -13.00 CASH 13.00 </pre> </div>
Item 1	PLU 10	(\$8.00)	
	Quantity	1	
Item 2	PLU 20	(\$5.00)	
	Quantity	1	
Payment	Cash	\$13.00	

Currency exchange function

When <CE> (currency exchange key) and <ST> are pressed, a current subtotal including tax is converted into foreign currency and the result is displayed.

Before using the currency exchange function, it is necessary to program the conversion rate and foreign currency amount symbol.

Registering foreign currency

Full amount tender in a foreign currency

* Pre-programmed exchange rate: ¥ 100 = \$0.9524

Important!

Tenders in a foreign currency can be registered using the **CA/AMT/TEND** and **CHK/TEND** only. Other finalize keys cannot be used.

OPERATION

1 0 00 **001**

← Enter the unit price and press the applicable flat-PLU key.

2 0 00 **002**

← Enter the next unit price and press the applicable flat-PLU key.

CE **SUB TOTAL**

← Press **CE** and **SUB TOTAL** without entering a numeric value. This operation converts the subtotal (including tax) dollar value into yen by applying a pre-programmed exchange rate. The result is shown on the display and printed on the receipt/journal by programming.

CE **5 0 00**
(¥5,000)

← Press **CE** and enter the amount tendered in yen. This operation converts the entered yen amount into dollars by applying a pre-programmed exchange rate. The result is shown on the display.

CA/AMT/TEND

← Press to finalize the transaction. Note that you do not need to reenter the dollar amount. The register automatically calculates the change amount due in dollars and shows it on the display, receipts and journal.

DISPLAY

REG	C01	03-04-03	17:00	001150
1	PLU0001			· 10.00
1	PLU0002			· 20.00
	TL			- 30.00
	CE			
	CASH			¥5,000
	CASH			· 47.62
	CG			· 17.62
CG				· 17.62

RECEIPT

REG	C01	03-04-2003	17:00
	MC #01		001150
1	PLU0001		· 10.00
2	DEPT02		· 20.00
	TL		- 30.00
	CE		
	CASH		¥5,000
	CASH		· 47.62
	CG		· 17.62

Partial tender in a foreign currency

* Pre-programmed exchange rate: ¥ 100 = \$0.9524

Important!

Tender in a foreign currency can be registered using **CA/AMT/TEND** and **CHK/TEND** only. Other finalization keys cannot be used, but the remaining tender in local currency can be finalized using any finalize key.

OPERATION

1 0 00 **001** ← Enter the unit price and press the applicable flat-PLU key.

2 0 00 **002** ← Enter the next unit price and press the applicable flat-PLU key.

CE **SUB TOTAL** ← Press **CE** and **SUB TOTAL** without entering a numeric value. This operation converts the subtotal (including tax) dollar value into yen by applying a pre-programmed exchange rate. The result is shown on the display and printed on the receipt/journal by programming.

CE **2 0 00** **(¥2,000)** ← Press **CE** and enter the partial amount tendered in yen.

This operation converts the entered yen amount into dollars by applying a pre-programmed exchange rate. The result is shown on the display.

CA/AMT/TEND ← Press **CA/AMT/TEND** to specify cash tender for the yen partial tender. Note that you do not need to reenter the dollar amount.

The register automatically deducts the dollar equivalent of the yen amount tendered from the total amount due and shows the rest amount on the display.

CHK/TEND ← Press to finalize the transaction.

DISPLAY

REG	C01	03-04-03 17:05	001151
1	PLU0001		- 10.00
1	PLU0002		- 20.00
	TL		- 30.00
	CE		
	CASH		¥2,000
	CASH		- 19.05
	CHECK		- 10.95
CHK			• 10.95

RECEIPT

REG	C01	03-04-2003 17:05	001151
		MC #01	
1	PLU0001		- 10.00
1	PLU0002		- 20.00
	TL		- 30.00
	CE		
	CASH		¥2,000
	CASH		- 19.05
	CHECK		- 10.95

Temporarily releasing compulsion

<OPEN> (open key) can release HDL (High Digit Limitation)/LDL (Low Digit Limitation) and can be programmed to release HAL (High Amount Limit).

<OPEN 2> (open 2 key) can be programmed to release specific compulsion.

Example 1

OPERATION			RECEIPT
Item	Flat 1	\$10.00	REG 03-04-2003 17:15 C01 MC #01 001160 1 PLU0001 .10.00 TL - 10.00 CASH .10.00
	HAL	\$1.00	
Payment	Cash	\$10.00	
1 0 00 001 ERROR occur * OPEN 1 0 00 001 CA/AMT /TEND			

* In this case, should be programmed to “release high amount limit”.

Example 2

OPERATION			RECEIPT
Input check No. compulsory			REG 03-04-2003 17:20 C01 MC #01 001161 1 PLU0001 .10.00 TL - 10.00 CHECK .10.00
Item	Flat 1	\$10.00	
	Quantity	1	
Payment	Check	\$10.00	
1 0 00 001 ERROR occur Input check No. compulsory OPEN 2 Compulsory is temporarily released. 1 0 00 001 1 0 00 CHK/ TEND			

VAT breakdown printing

You can force printing of the VAT breakdown at the finalize stage, regardless of whether the cash register is programmed to print or skip printing of the VAT breakdown. Every time you want to have VAT breakdown, press <VAT>.

Example

OPERATION			RECEIPT			
Item 1	Flat 1	\$1.00	1	00	001	REG 03-04-2003 17:20 C01 MC #01 001161 1 PLU0001 T1 -1.00 1 PLU0002 T2 -2.00 TA1 -0.90 TX1 -0.10 TA2 -1.90 TX2 -0.10 TL -3.00 CASH -3.00
	Taxable	1	2	00	002	
Item 2	Flat 2	\$2.00			VAT	
	Taxable	2			CA / AMT TEND	
Payment	Cash	\$3.00				

Advanced Operations

Registering loan amounts

Use this procedure to register loan or bank received from the office.

	OPERATION	RECEIPT												
<table border="1" style="width: 100%; border-collapse: collapse;"> <tr> <td rowspan="4" style="text-align: center; vertical-align: middle;">Item</td> <td style="text-align: center;">Note</td> <td style="text-align: right;">\$1.00</td> </tr> <tr> <td style="text-align: center;">Quantity</td> <td style="text-align: center;">10</td> </tr> <tr> <td style="text-align: center;">Note</td> <td style="text-align: right;">\$5.00</td> </tr> <tr> <td style="text-align: center;">Quantity</td> <td style="text-align: center;">5</td> </tr> <tr> <td style="text-align: center;">Media</td> <td style="text-align: center;">Cash</td> <td style="text-align: right;">\$35.00</td> </tr> </table>	Item	Note	\$1.00	Quantity	10	Note	\$5.00	Quantity	5	Media	Cash	\$35.00	<div style="display: flex; flex-direction: column; align-items: center; gap: 10px;"> <div style="display: flex; gap: 5px;"> 1 0 X </div> <div style="display: flex; gap: 5px;"> 1 00 LOAN </div> <div style="display: flex; gap: 5px;"> 5 X </div> <div style="display: flex; gap: 5px;"> 5 00 LOAN </div> <div style="border: 1px solid black; padding: 2px 5px; font-size: small;">CA/AMT TEND</div> </div>	<div style="border: 1px solid black; padding: 5px; font-family: monospace; font-size: small;"> REG 03-04-2003 11:25 C01 MC #01 000030 LOAN ·10.00 LOAN ·25.00 CASH - 35.00 </div>
Item		Note	\$1.00											
		Quantity	10											
		Note	\$5.00											
	Quantity	5												
Media	Cash	\$35.00												

Registering pick up amounts

Use this procedure to register pick up money from cash drawer.

	OPERATION	RECEIPT												
<table border="1" style="width: 100%; border-collapse: collapse;"> <tr> <td rowspan="4" style="text-align: center; vertical-align: middle;">Item</td> <td style="text-align: center;">Coin</td> <td style="text-align: right;">\$0.50</td> </tr> <tr> <td style="text-align: center;">Quantity</td> <td style="text-align: center;">10</td> </tr> <tr> <td style="text-align: center;">Coin</td> <td style="text-align: right;">\$0.10</td> </tr> <tr> <td style="text-align: center;">Quantity</td> <td style="text-align: center;">5</td> </tr> <tr> <td style="text-align: center;">Media</td> <td style="text-align: center;">Cash</td> <td style="text-align: right;">\$5.50</td> </tr> </table>	Item	Coin	\$0.50	Quantity	10	Coin	\$0.10	Quantity	5	Media	Cash	\$5.50	<div style="display: flex; flex-direction: column; align-items: center; gap: 10px;"> <div style="display: flex; gap: 5px;"> 1 0 X </div> <div style="display: flex; gap: 5px;"> 5 0 PICK UP </div> <div style="display: flex; gap: 5px;"> 5 X </div> <div style="display: flex; gap: 5px;"> 1 0 PICK UP </div> <div style="border: 1px solid black; padding: 2px 5px; font-size: small;">CA/AMT TEND</div> </div>	<div style="border: 1px solid black; padding: 5px; font-family: monospace; font-size: small;"> REG 03-04-2003 11:30 C01 MC #01 000031 P. UP ·5.00 P. UP ·0.50 CASH - 5.50 </div>
Item		Coin	\$0.50											
		Quantity	10											
		Coin	\$0.10											
	Quantity	5												
Media	Cash	\$5.50												

Changing media in drawer

Use this procedure to change media in drawer.

	OPERATION	RECEIPT							
<table border="1" style="width: 100%; border-collapse: collapse;"> <tr> <td rowspan="3" style="text-align: center; vertical-align: middle;">Media</td> <td style="text-align: center;">Check</td> <td style="text-align: right;">-10.00</td> </tr> <tr> <td style="text-align: center;">Cash</td> <td style="text-align: right;">\$8.00</td> </tr> <tr> <td style="text-align: center;">Charge</td> <td style="text-align: right;">\$2.00</td> </tr> </table>	Media	Check	-10.00	Cash	\$8.00	Charge	\$2.00	<div style="display: flex; flex-direction: column; align-items: center; gap: 10px;"> <div style="display: flex; gap: 5px;"> 1 0 00 MEDIA CHANGE </div> <div style="display: flex; gap: 5px;"> 8 00 CHK/ TEND </div> <div style="font-size: x-small;">Enter the amount to be changed.</div> <div style="display: flex; gap: 5px;"> 2 00 CA/AMT TEND </div> <div style="display: flex; gap: 5px;"> 2 00 CH </div> </div>	<div style="border: 1px solid black; padding: 5px; font-family: monospace; font-size: small;"> REG 03-04-2003 11:35 C01 MC #01 000032 MEDIA CHG ······ CHECK -10.00 CASH ·8.00 CHARGE ·2.00 </div>
Media		Check	-10.00						
		Cash	\$8.00						
	Charge	\$2.00							

Scanning PLU

Product barcodes are read by scanning with hand-held scanner, and are filed in the scanning PLU link file. The unit price, item descriptor, programming status, link department, totalizer and counter, the register are filed in the PLU link file.

When a barcode is entered by scanning, or from the keyboard by using <OBR> (OBR key), the register searches its scanning PLU link file and finds the preset unit price to accumulate to the PLU file.

Scanning PLUs include UPC-A/EAN-13/EAN-8, source marking, in-store marking code.

Item registration

By scanner/code input

	OPERATION	RECEIPT																																									
<table border="1" style="width: 100%; border-collapse: collapse;"> <tr> <td style="width: 20%;">Item 1 (scan)</td> <td style="width: 20%;">Scan-PLU</td> <td style="width: 20%;">(\$2.35)</td> <td style="width: 20%;"></td> </tr> <tr> <td></td> <td>PLU code</td> <td>49012347</td> <td></td> </tr> <tr> <td>Item 2 (code)</td> <td>Scan-PLU</td> <td>(\$2.00)</td> <td></td> </tr> <tr> <td></td> <td>PLU code</td> <td>123456</td> <td></td> </tr> <tr> <td>Payment</td> <td>Cash</td> <td>\$5.00</td> <td></td> </tr> </table>	Item 1 (scan)	Scan-PLU	(\$2.35)			PLU code	49012347		Item 2 (code)	Scan-PLU	(\$2.00)			PLU code	123456		Payment	Cash	\$5.00		<p>“Scanning”</p> <p>1 2 3</p> <p>4 5 6 OBR</p> <p>Scanning-PLU code and OBR key</p> <p>5 00 CA/AMT TEND</p>	<table border="1" style="width: 100%; border-collapse: collapse;"> <tr> <td>REG</td> <td>03-04-2003</td> <td>17:25</td> </tr> <tr> <td>C01</td> <td>MC #01</td> <td>001162</td> </tr> <tr> <td>1 PLU0100</td> <td></td> <td style="text-align: right;">.2.35</td> </tr> <tr> <td>1 PLU0101</td> <td></td> <td style="text-align: right;">.2.00</td> </tr> <tr> <td>TL</td> <td></td> <td style="text-align: right;">- 4.35</td> </tr> <tr> <td>CASH</td> <td></td> <td style="text-align: right;">.5.00</td> </tr> <tr> <td>CG</td> <td></td> <td style="text-align: right;">.0.65</td> </tr> </table>	REG	03-04-2003	17:25	C01	MC #01	001162	1 PLU0100		.2.35	1 PLU0101		.2.00	TL		- 4.35	CASH		.5.00	CG		.0.65
Item 1 (scan)	Scan-PLU	(\$2.35)																																									
	PLU code	49012347																																									
Item 2 (code)	Scan-PLU	(\$2.00)																																									
	PLU code	123456																																									
Payment	Cash	\$5.00																																									
REG	03-04-2003	17:25																																									
C01	MC #01	001162																																									
1 PLU0100		.2.35																																									
1 PLU0101		.2.00																																									
TL		- 4.35																																									
CASH		.5.00																																									
CG		.0.65																																									

Unit price inquiry

Use this operation to recall the unit prices of departments, subdepartments, PLUs, second unit price of PLUs, or scanning PLUs.

The unit prices appear on the display of the cash register when recalled.

Example

To check the unit price of flat-PLU 001.

OPERATION	DISPLAY																				
<p>PRICE INQ</p> <p>001</p>	<table border="1" style="width: 100%; border-collapse: collapse;"> <tr> <td>REG</td> <td>C01</td> <td>03-04-03</td> <td>17:30</td> <td>001162</td> </tr> <tr> <td>1</td> <td>PLU0004</td> <td></td> <td></td> <td style="text-align: right;">.10.00</td> </tr> <tr> <td>1</td> <td>PLU0002</td> <td></td> <td></td> <td style="text-align: right;">.20.00</td> </tr> <tr> <td colspan="4">PLU0001</td> <td style="text-align: right;">.10.00</td> </tr> </table>	REG	C01	03-04-03	17:30	001162	1	PLU0004			.10.00	1	PLU0002			.20.00	PLU0001				.10.00
REG	C01	03-04-03	17:30	001162																	
1	PLU0004			.10.00																	
1	PLU0002			.20.00																	
PLU0001				.10.00																	

Programming to clerk

You can program up to 4-digit clerk number (secret number), trainee status of clerk (i.e. training cashier) and clerk name (up to 16 characters) etc. for each clerk.

Programming procedure

- Step 1. Press <PGM MODE> three times to turn “PGM-3”, select “2.Clerk” YES, select “1.Clerk Feature” YES.
 Step 2. Select the appropriate clerk and press YES.

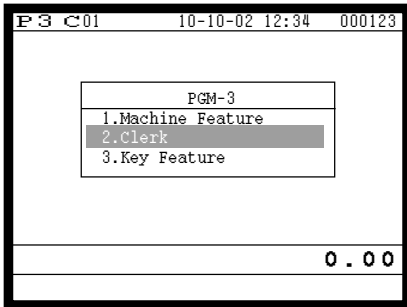

Step 1. screen

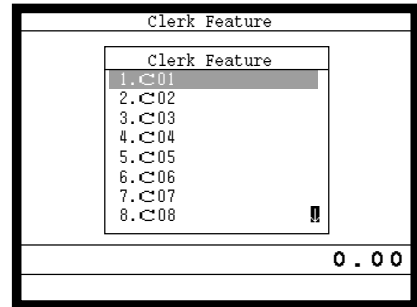

Step 2. screen

Step 3. Clerk descriptor programming:

Select “Descriptor” line, press YES, enter clerk name within 16 characters and YES.

Secret number programming:

Select “Secret number” line, and press YES, enter clerk sector number within 4 digits and YES.

Training status programming:

Select “Treat as Trainee” line, and select YES or NO.

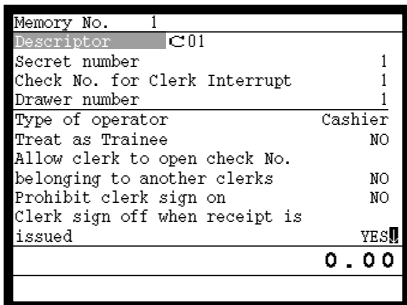

Step 3-1. screen

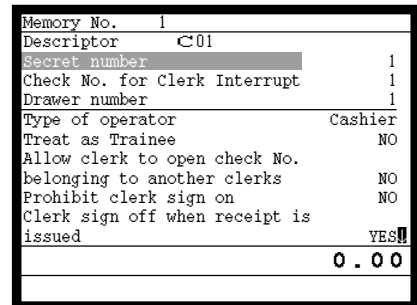

Step 3-2. screen

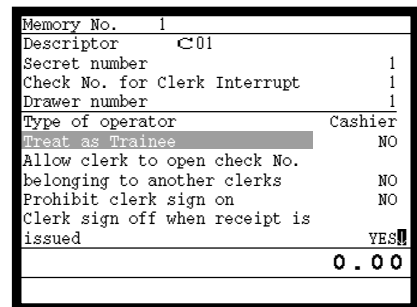

Step 3-3. screen

Step 4. Repeat the step 3., if you program the next record.

Press ESC/SKIP and repeat the step 2 and 3., if you program to the other record.

Step 5. Press ESC/SKIP repeatedly to return to the “Step 1. screen”.

Programming descriptors and messages

Programming item descriptor (flat-PLU) procedure

Step 1. Press <PGM MODE> two times to turn “PGM-2”, select “1.Item Descriptor” and press **YES**.

Step 2. Select “1.PLU” and press **YES**.

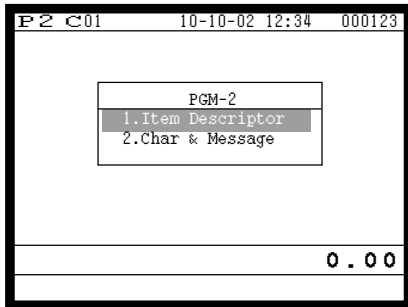

Step 1. screen

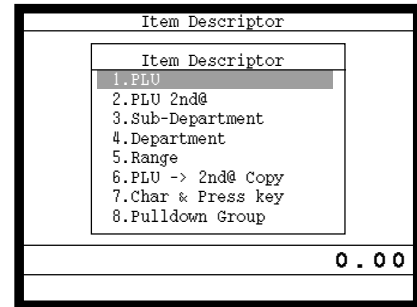

Step 2. screen

Step 3. Select the PLU record you want to program by pressing the flat-PLU key directly, by entering PLU record No. and **YES**, or by entering random PLU code and **PLU**.

Step 4. Enter characters and **YES**.

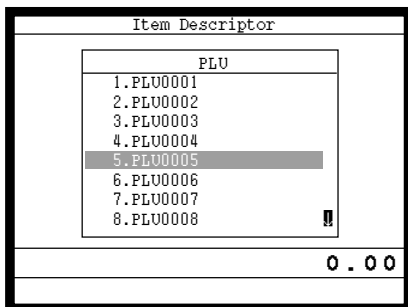

Step 3. screen

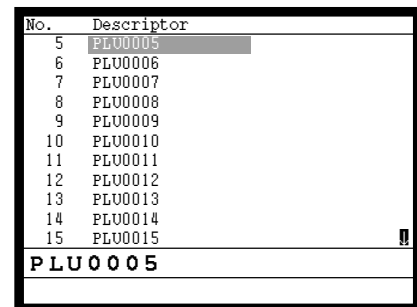

Step 4. screen

Step 5. Repeat the step 4., if you program the next record.

Press **ESC/SKIP** and repeat the step 3. and 4., if you program to the other record.

Step 6. Press **ESC/SKIP** repeatedly to return to the “Step 1. screen”.

Advanced Operations

Programming function key character procedure

- Step 1. Press <PGM MODE> two times to turn “PGM-2”, select “1.Item Descriptor” and press **YES**.
 Step 2. Select “7.Char & Press key” and press **YES**.

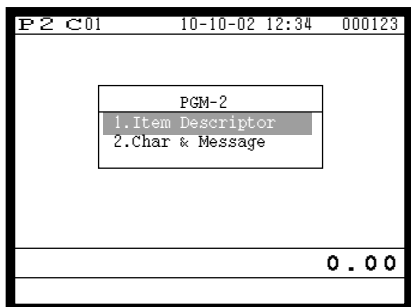

Step 1. screen

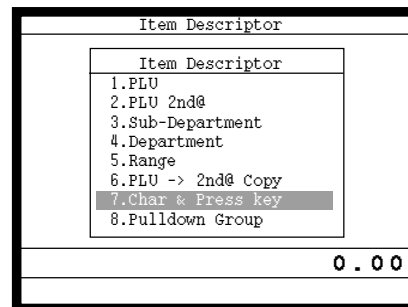

Step 2. screen

- Step 3. Enter key characters, press **YES**, and press the corresponding key.

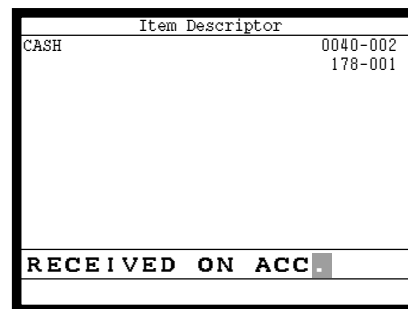

Step 3. screen

- Step 4. Repeat the step 3., if you have other keys to program.
 Step 5. Press **ESC/SKIP** repeatedly to return to the “Step 1. screen”.

The initial characters of function keys

Function	Code	Initial character	Function	Code	Initial character
Cash amount tendered	001	CASH	Non-add/No sale	041	#/NS
Charge	002	CHARGE	Customer number	043	CT
Check tender	003	CHECK	PLU	048	PLU#
Credit	004	CREDIT	Price	049	PRC
New balance	006	NB	Menu shift	064	MENU
Table transfer	014	TABLE TRANS	Open	067	OPEN
Received on account	020	RC	Subtotal	075	SUBTOTAL
Paid out	021	PD	Multiplication	082	X
Minus	027	-	New/Old check	093	NEW/OLD
Discount	028	%-	Media change	118	MEDIA CHG
Refund	033	RF	List number	137	LIST#
Error correct/Void	034	VOID	Cancel	236	CANCEL
Receipt	038	RCT			

Programming receipt/slip message procedure

Step 1. Press <PGM MODE> two times to turn “PGM-2”, select “2.Char & Message” and press **YES**.

Step 2. Select “1.Receipt/SLIP Msg” and press **YES**.

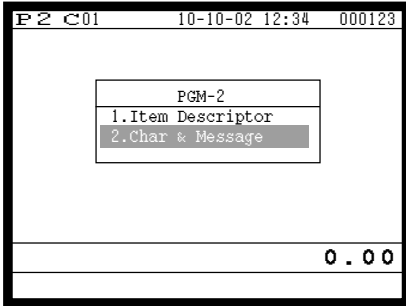

Step 1. screen

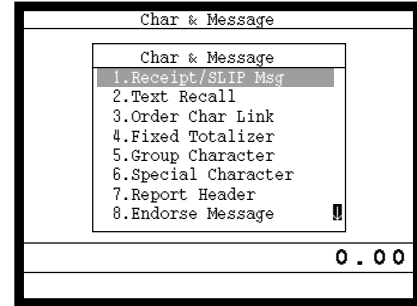

Step 2. screen

Step 3. Select the appropriate record, press **YES** and enter characters and press **YES**.

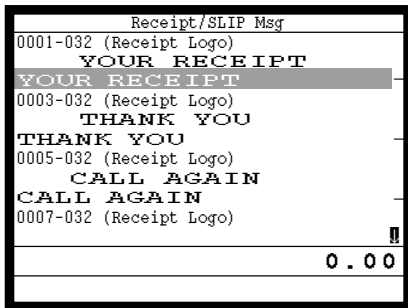

Step 3. screen

Select these lower (even number) record

Select these lower (even number) record

Select these lower (even number) record

Rec No.	Message
2, 4, 6, 8	Receipt logo message
10, 12, 14, 16	Receipt commercial message
18, 20, 22, 24	Receipt bottom message
26, 28, 30, 32	Bill top message
34, 36, 38, 40	Bill copy message
42, 44, 46, 48	Bill bottom message
50, 52, 54, 56	Slip logo message
58, 60, 62, 64	Slip intermediate message
66, 68, 70, 72	Slip bottom message
74	Post receipt
76, 78, 80, 82, 84, 86, 88, 90, 92, 94	Guest bottom message
96	E-journal copy receipt message

Odd records are used for external printer.

Step 4. Repeat the step 3., if you have other records to program.

Step 5. Press **ESC/SKIP** repeatedly to return to the “Step 1. screen”.

Entering characters

In this section, the method to enter descriptors or messages (characters) to the cash register during programming is described.

Characters are specified by character keyboard or by codes. In the first half of this section, the usage of character keyboard is described. In the latter half, inputting method by character code is described.

Using character keyboard

Example:

Input “ **A** p p l e J u i c e ”,
 enter “DBL” “A” “SHIFT” “DBL” “p” “p” “l” “e” “SPACE” “CAP” “J” “SHIFT” “u” “i” “c” “e” **YES** .

① Shift key

Press this key to shift the following characters from the uppercase letter to lowercase letter and returns to the uppercase letter in sequence.

② Left cursor key

Press this key to shift the character setting position to the left one by one. This key is used to correct already entered characters.

③ Right cursor key

Press this key to shift the character setting position to the right one by one. This key is used to correct already entered characters.

④ Double size letter key

Press this key to specify that the next character you input to a double size character.

⑤ Space key

Press this key to set a space.

⑥ CAP key

Press this key to shift the character to the uppercase letter.

⑦ Alphabet keys

Press these keys to input characters.

⑧ Numeric keys

Press these keys to enter program codes, memory number and character codes.

⑨ Yes key

Press this key when the alphabetic entry for a descriptor, name or message has been completed. This key is also used for editing the programmed characters.

TE-8000F

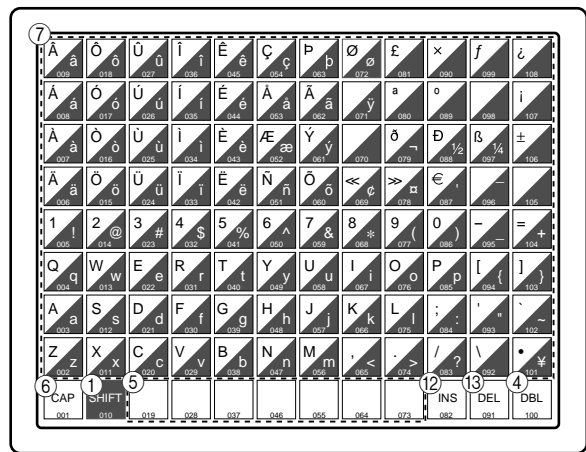
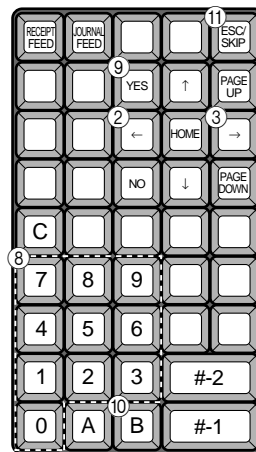

TE-8500F

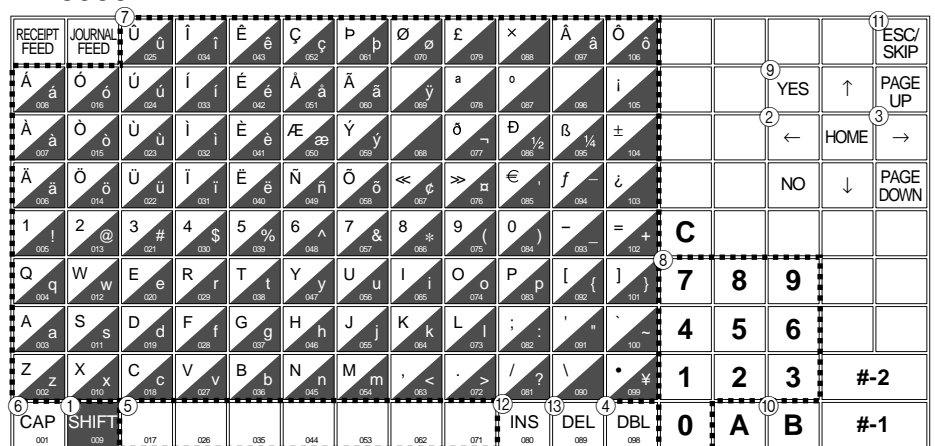

⑩ Backspace key

Press this key to move the character placed behind.

⑪ ESC/SKIP key

Press this key to terminate the character programming.

⑫ Insert key

Press this key to put one space between the original characters.

⑬ Delete key

Press this key to clear the designated character.

Entering characters by code

Every time you enter a character, choose character codes by the character code list (below) and press the **B** key to settle it. After you complete entering characters, press the **YES** key to fix them.

Example:

Input “ **A** p p l e J u i c e ”,
 enter “ 255 **B** 65 **B** 255 **B** 112 **B** 112 **B** 108 **B** 101 **B** 32 **B** 74 **B** 117 **B** 105 **B** 99 **B** 101 **B** **YES** ”

Character code list

Chara	Code	Chara	Code	Chara	Code	Chara	Code	Chara	Code	Chara	Code	Chara	Code
Space	32	0	48	@	64	P	80	'	96	p	112	Ç	128
!	33	1	49	A	65	Q	81	a	97	q	113	ü	129
”	34	2	50	B	66	R	82	b	98	r	114	é	130
#	35	3	51	C	67	S	83	c	99	s	115	â	131
\$	36	4	52	D	68	T	84	d	100	t	116	ä	132
%	37	5	53	E	69	U	85	e	101	u	117	à	133
&	38	6	54	F	70	V	86	f	102	v	118	â	134
'	39	7	55	G	71	W	87	g	103	w	119	ç	135
(40	8	56	H	72	X	88	h	104	x	120	ê	136
)	41	9	57	I	73	Y	89	i	105	y	121	ë	137
*	42	:	58	J	74	Z	90	j	106	z	122	è	138
+	43	;	59	K	75	[91	k	107	{	123	ï	139
,	44	<	60	L	76	\	92	l	108		124	î	140
-	45	=	61	M	77]	93	m	109	}	125	ì	141
.	46	>	62	N	78	^	94	n	110	~	126	Ä	142
/	47	?	63	O	79	_	95	o	111	⌘	127	Å	143

Chara	Code	Chara	Code	Chara	Code	Chara	Code	Chara	Code	Chara	Code	Chara	Code
É	144	á	160	I	176	Ł	192	Ǿ	208	Ó	224		240
æ	145	í	161	II	177	⊥	193	D	209	ß	225	±	241
Æ	146	ó	162	III	178	⊥	194	Ê	210	Ô	226		242
ô	147	ú	163		179	⊥	195	Ë	211	Ò	227		243
ö	148	ñ	164	⊥	180	—	196	È	212	ö	228		244
ò	149	Ñ	165	Á	181	+	197	€	213	Õ	229		245
û	150	ª	166	Â	182	ã	198	Í	214	μ	230	←	246
ù	151	º	167	À	183	Ã	199	Î	215	þ	231	→	247
ÿ	152	¿	168		184	⌘	200	Ï	216	þ	232	↑	248
Ö	153		169	≡	185	≡	201	⋄	217	Ú	233	↓	249
Û	154	↯	170		186	≡	202	⋄	218	Û	234	•	250
ø	155	1/2	171	≡	187	≡	203		219	Ü	235		251
£	156	1/4	172	≡	188	≡	204		220	ý	236		252
Ø	157	¡	173	¢	189	≡	205	¡	221	Ý	237		253
×	158	«	174	¥	190	≡	206	ì	222	—	238		254
f	159	»	175	⌘	191	≡	207		223	˘	239	Double size	255

Advanced Operations

Editing characters

Correcting a character just entered

	OPERATION	DISPLAY
“L” “E” “N” “O” “N”	↵ Enter LENON, instead of LEMON.	LENON
← ← ←	↵ Press left arrow key three times.	LENON
“M”	↵ Enter “M”.	LEMON

Correcting and adding/deleting an item descriptor already set

	OPERATION	DISPLAY
1 5 PLU	↵ Designate the item.	APPLE
YES	↵ Press <YES> to enter edit mode.	APPLE
→ →	↵ Press right arrow key two times.	APPLE
INS	↵ Press <INS> (insert) key.	AP LE
“p”	↵ Enter “p”.	APPLE

	OPERATION	DISPLAY
2 5 PLU	↵ Designate the item.	MOULSE
YES	↵ Press <YES> to enter edit mode.	MOULSE
→ → →	↵ Press right arrow key three times.	MOULSE
DEL	↵ Press (delete) key.	MOUSE

	OPERATION	DISPLAY
3 5 PLU	↵ Designate the item.	MOULE
YES	↵ Press <YES> to enter edit mode.	MOULE
→ → →	↵ Press right arrow key three times.	MOULE
BS	↵ Press <BS> (backspace) key.	MOLE

Printing read/reset reports

• Read (X) report

You can display or print read reports at any time during the business day without affecting the data stored in the cash register.

• Reset (Z) report

After issuing a reset report, the totals stored in the cash register are reset. So, you should not print reset reports during the business day.

Important!

- The reset operation issues a report and also clears all sales data from the cash register's memory.
- Be sure to perform the reset operations at the end of each business day. Otherwise, you will not be able to distinguish between the sales data for different dates.

The tree of X/Z menu window

You can issue these kinds of report by tracing this tree.

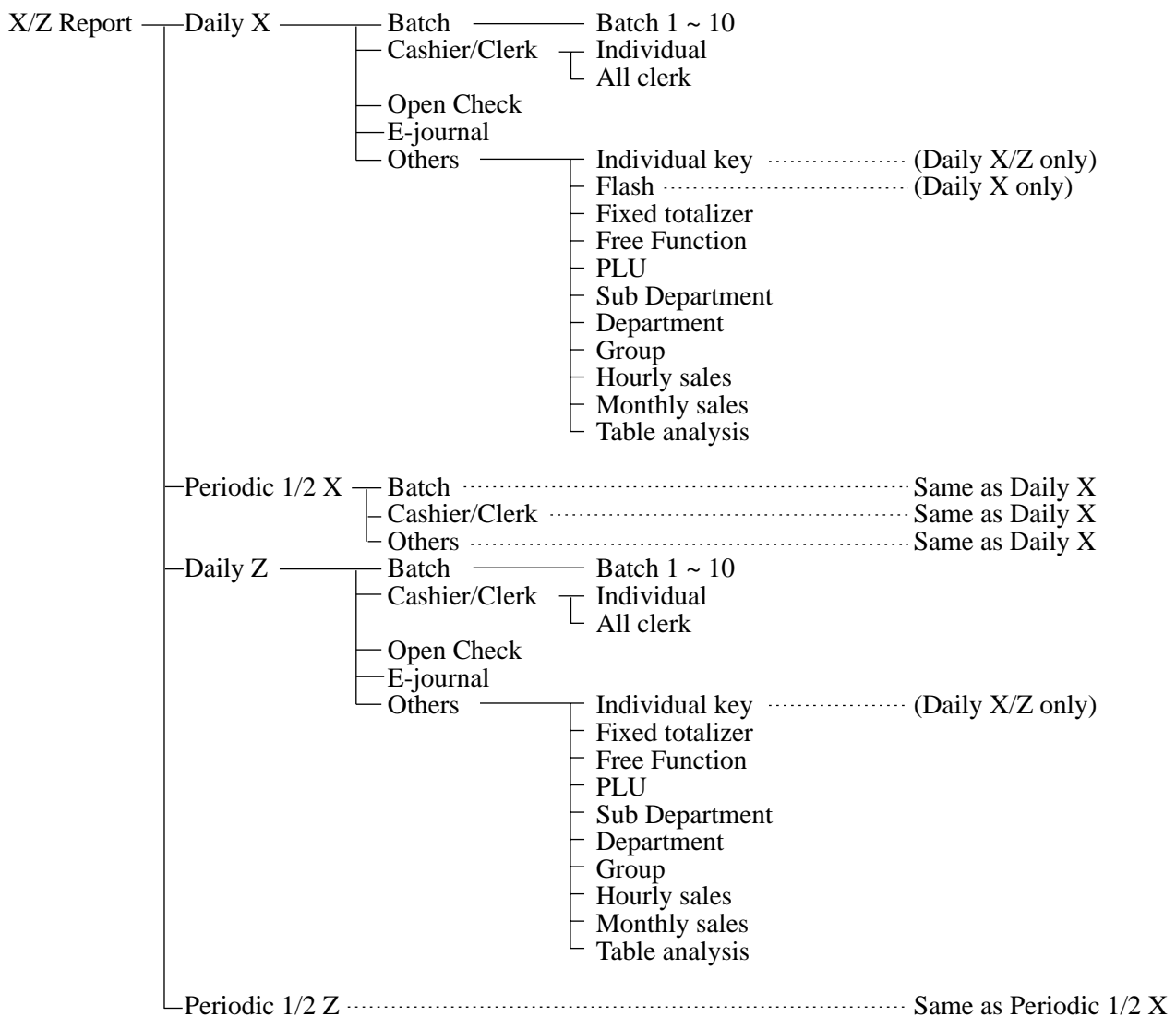

Advanced Operations

To print the individual key (department, subdepartment, PLU/flat-PLU, function) read report

This report shows sales for specific keys.

Procedure

Step 1. Press <X/Z MODE> to turn "X/Z Report".

Step 2. Select "1.Daily X" and press .

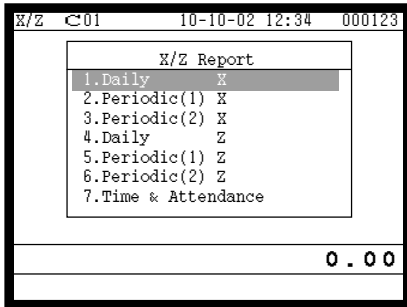

Step 1. screen

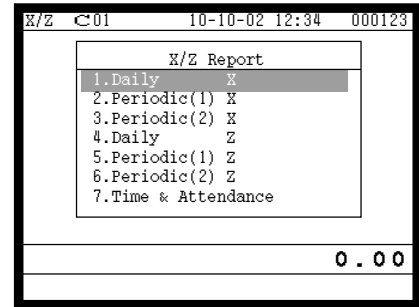

Step 2. screen

Step 3. Select "5.Others" and press .

Step 4. Select "1.Individual keys" and press .

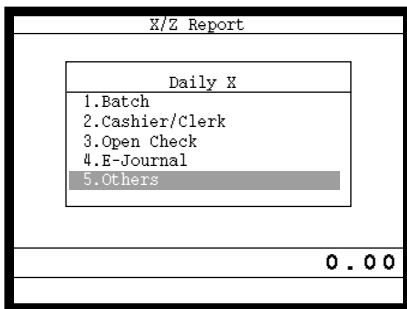

Step 3. screen

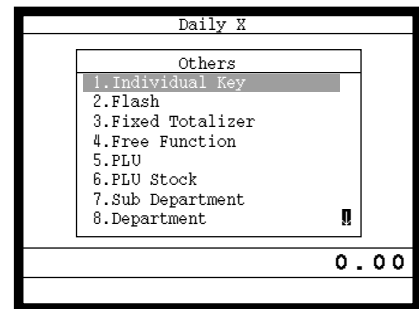

Step 4. screen

Step 5. Select keys you want to read. (The display shows totalizer/counter of the key.)

Step 6. After you finish to select keys, press to terminate this procedure – a report is issued.

Report

X		0000095	Read symbol
			Report code
PLU0001		17	PLU name/No. of items
		.17.00	Amount
DISCOUNT		.2.50	Discount amount
#000001	0.53%		PLU code/Sales ratio
DEPT01		38	Department name/No. of items
		.257.53	Amount
	8.13%		Sales ratio
DISCOUNT		.5.80	Discount amount
CASH	No	11	Key descriptor/Key count
		.128.03	Key total
%-	No	2	
		.10.29	
TL		88.618	Total No. of items
		.516.10	Total amount
DISCOUNT		.9.50	Discount amount total
	10.83%		Sales ratio

To print the financial read report

This report shows net sales, cash, charge, check and credit in drawer.

Procedure

Step 1. Press <X/Z MODE> to turn “X/Z Report”.

Step 2. Select “1.Daily X” and press .

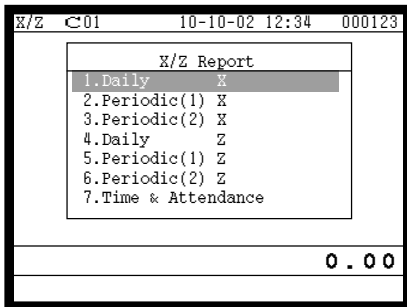

Step 1. screen

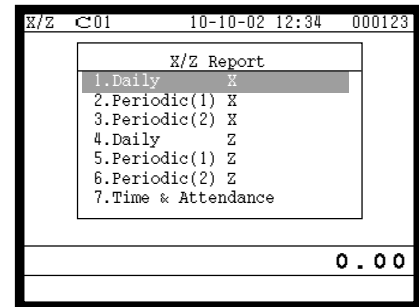

Step 2. screen

Step 3. Select “5.Others” and press .

Step 4. Select “2.Flash” and press . The declared drawer amount by <#> or <#/NS> should be entered before this step.

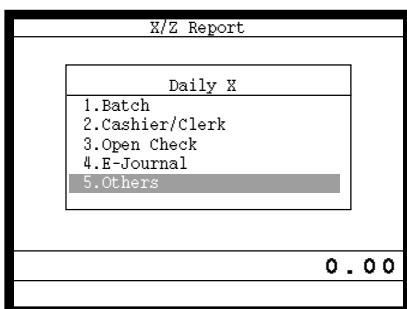

Step 3. screen

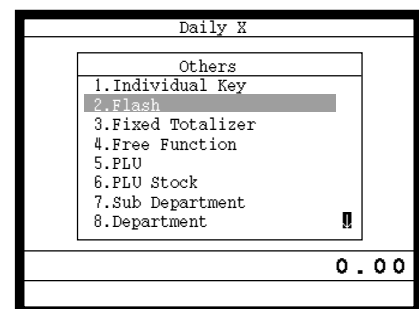

Step 4. screen

Step 5. Press repeatedly to return to the “Step 1. screen”.

Report

X	FLASH	0000071	Read symbol/Report title Report code
#		-6,919.04	Declared cash in drawer ^{*1}
		-0.00	Difference (= declared - accumulated) ^{*1}
NET	No	120	No. of net sales
		-7,263.20	Net amount
CAID		-6,919.04	Cash in drawer
CHID		-178.60	Charge in drawer
CKID		-172.85	Check in drawer
CRID		-6.00	Credit in drawer

^{*1} Money declaration:

Count how much cash is in the drawer and input this amount (up to 10 digits).

The cash register will automatically compare the input with the cash in drawer in the memory and print the difference between these two amounts.

Note that if money declaration is required by programming, you cannot skip this procedure.

Advanced Operations

To print the individual clerk read/reset report

This report shows individual clerk totals.

Procedure

Step 1. Press <X/Z MODE> to turn “X/Z Report”, select “1.Daily X” or “4.Daily Z” and press **YES**.

Step 2. Select “2.Cashier/Clerk” and press **YES**.

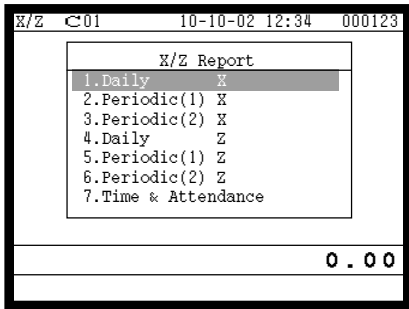

Step 1. screen

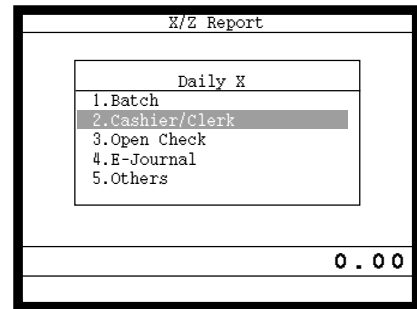

Step 2. screen

Step 3. Select “1.Individual” and press **YES**.

Step 4. Enter clerk No., press **YES** twice. The declared drawer amount by <#> or <#/NS> should be entered before this step.

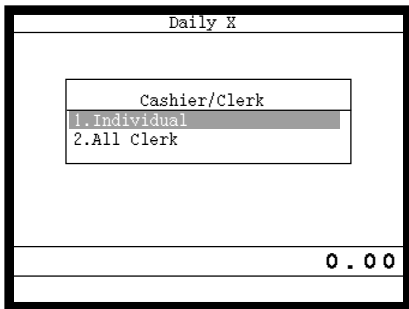

Step 3. screen

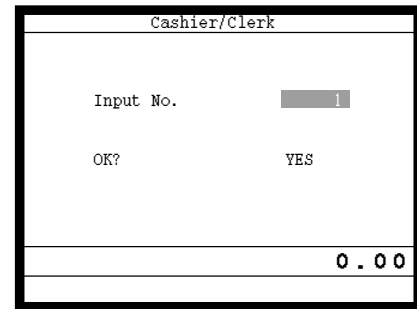

Step 4. screen

Step 5. Repeat the step 4., if you have other clerks to read.

Step 6. After you finish to select keys, press **ESC/SKIP** to terminate this procedure.

Report

X	CASHIER/CLERK	0020017	Read symbol/report title
			Command code
#		-6,919.04	Declared cash in drawer of main currency *1
		-0.00	Difference (= declared - accumulated) *1
C01	1	Clerk name/drawer No.
GROSS		23.498	Gross total
		-7,543.48	
NET	No	120	Net total
		-7,263.20	
CAID		-6,919.04	Cash in drawer
CHID		-178.60	Charge in drawer
CKID		-172.85	Check in drawer
CRID		-6.00	Credit in drawer

*1 Money declaration:

Count how much cash is in the drawer and input this amount (up to 10 digits).

The cash register will automatically compare the input with the cash in drawer in the memory and print the difference between these two amounts.

Note that if money declaration is required by programming, you cannot skip this procedure.

To print the daily sales read/reset report

Please refer to “Printing the daily sales reset report” section on page 48 of this manual.

To print the periodic 1/2 sales read/reset reports

These reports show breakdowns of sales by any two kinds of period you want.

Procedure

Step 1. Press <X/Z MODE> to turn “X/Z Report”.

Step 2. Select “2.Periodic(1) X”, “3.Periodic(2) X”, “5.Periodic(1) Z” or “6.Periodic(2) Z” and press .

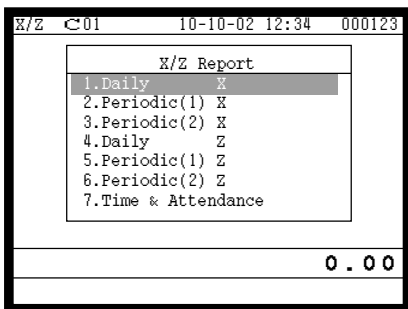

Step 1. screen

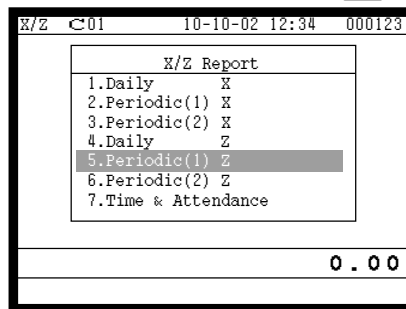

Step 2. screen

Step 3. Select “1.Batch” and press .

Step 4. Select “1.Batch(1)” and press .

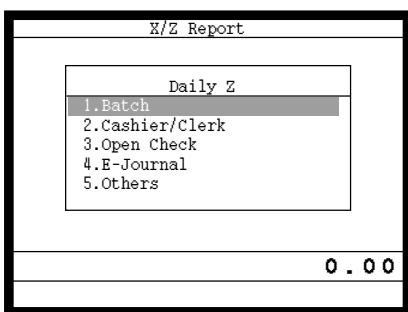

Step 3. screen

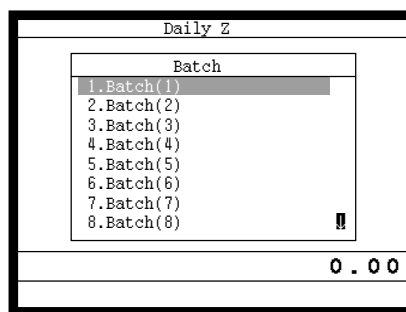

Step 4. screen

Step 5. Press repeatedly to return to the “Step 1. screen”.

Report

ZZ1 FIXED TTL	1	Mode*/report title/reset counter
	0001111	Report code
GROSS	981.250	Gross total
NET	No 111	Net total
CAID	·1,919.04	Cash in drawer
CK	·859.85	Check in drawer
EX10	-0.00	
ZZ1 FREE FUNCTION	1	Mode*/report title/reset counter
	0001112	Report code
CASH	No 362	Function key count/amount
	·1,638.04	
	No 5	
CANCEL	·100.28	

ZZ1 DEPT	1	Mode*/report title/reset counter
	0001115	Report code
DEPT01	203.25	Department count/amount
	·1,108.54	
	·10.00	
DISCOUNT	20	
TL	421.25	Department total
	·2,872.28	
DISCOUNT	·12.08	
ZZ1 CASHIER/CLERK	1	Mode*/report title/reset counter
	0001117	Report code
C011	Clerk name/drawer No.
GROSS	421.254	
	·2,872.28	
NET	No 111	
	·1,845.35	

* Mode:
 XX1 = Periodic(1) X
 ZZ1 = Periodic(1) Z
 XX2 = Periodic(2) X
 ZZ2 = Periodic(2) Z

Advanced Operations

To print the PLU read/reset report

This report shows sales for PLUs.

Procedure

Step 1. Press <X/Z MODE> to turn “X/Z Report”.

Step 2. Select “1.Daily X”, “2.Periodic(1) X”, “3.Periodic(2) X”, “4.Daily Z”, “5.Periodic(1) Z”, “6.Periodic(2) Z” and press **YES**.

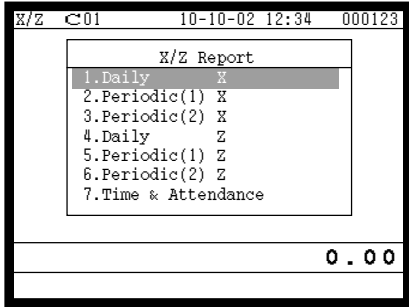

Step 1. screen

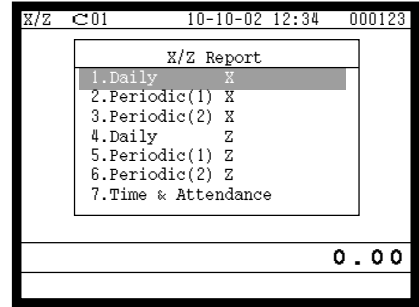

Step 2. screen

Step 3. Select “5.Others” and press **YES**.

Step 4. Select “5.PLU” and press **YES**, then select “1.All” and press **YES**.

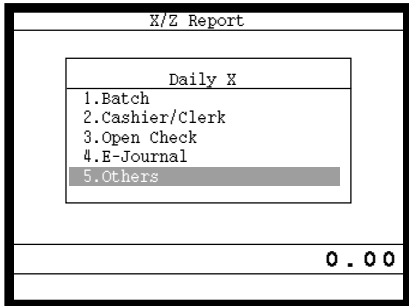

Step 3. screen

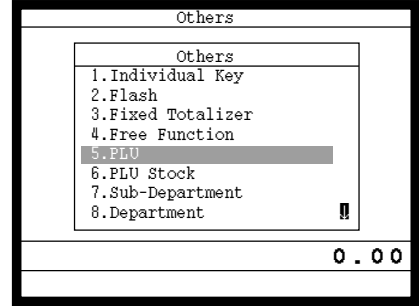

Step 4. screen

Step 5. Press **ESC/SKIP** repeatedly to return to the “Step 1. screen”.

Report

X	PLU	0000014	Read symbol/report title
			Report code
PLU0001		17	PLU name/No. of items
		.17.00	PLU amount
DISCOUNT		.2.50	Discount amount
HOUSE BON QTY		2	House Bon quantity
#000001	0.53%		PLU code/sales ratio/
<hr/>			
PLU0100		.69.00	
		.0.50	
DISCOUNT			
HOUSE BON QTY		0	
#000100	4.03%		
<hr/>			
TL		188.61	Total No. of items
		.516.10	Total amount
DISCOUNT		.9.50	Discount amount total
HOUSE BON QTY		17	House Bon quantity total
	17.92%		Sales ratio

To print the hourly sales read/reset report

This report shows hourly breakdowns of sales.

Procedure

Step 1. Press <X/Z MODE> to turn “X/Z Report”.

Step 2. Select “1.Daily X”, “2.Periodic(1) X”, “3.Periodic(2) X”, “4.Daily Z”, “5.Periodic(1) Z”, “6.Periodic(2) Z” and press .

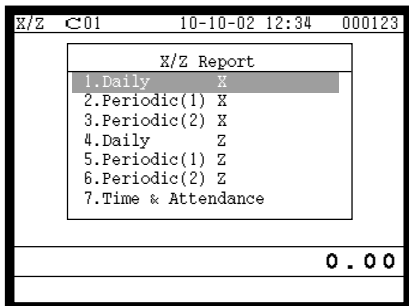

Step 1. screen

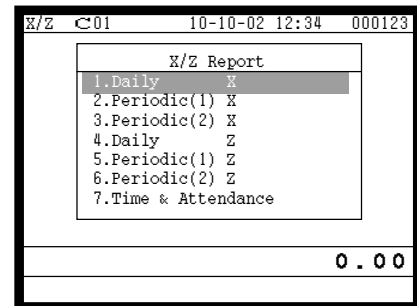

Step 2. screen

Step 3. Select “5.Others” and press .

Step 4. Select “10.Hourly Sales” and press .

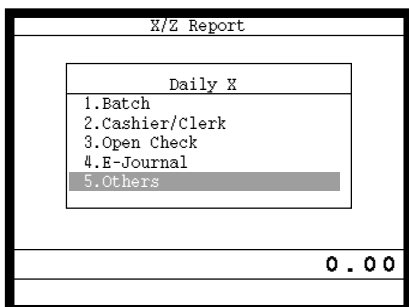

Step 3. screen

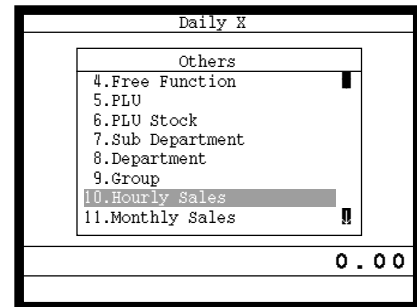

Step 4. screen

Step 5. Press repeatedly to return to the “Step 1. screen”.

Report

X	HOURLY			0000019	Read symbol/report title
					Report code
00:00->01:00		1			Time range/no. of net sales
				-1.20	Net sales amount
1.90%					Sales ratio
		CT	1		No. of customers
				-1.20	Sum. of merchandise subtotal
01:00->02:00			12		
				-12.00	
19.00%					
~~~~~					
23:00->00:00		1			
				-3.59	
3.90%					
		CT	1		
				-3.59	

# Advanced Operations

## To print the monthly sales read/reset report

This report shows monthly breakdowns of sales.

### Procedure

Step 1. Press <X/Z MODE> to turn “X/Z Report”.

Step 2. Select “1.Daily X”, “2.Periodic(1) X”, “3.Periodic(2) X”, “4.Daily Z”, “5.Periodic(1) Z”, “6.Periodic(2) Z” and press **YES**.

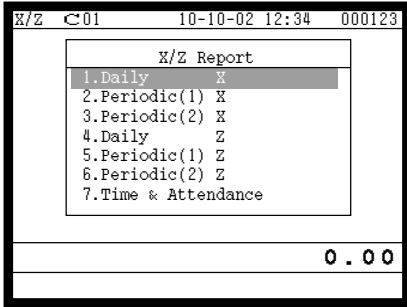

Step 1. screen

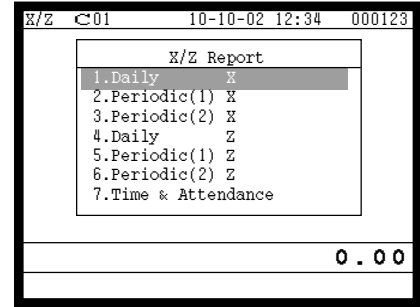

Step 2. screen

Step 3. Select “5.Others” and press **YES**.

Step 4. Select “11.Monthly Sales” and press **YES**.

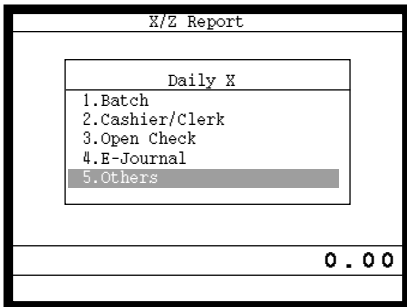

Step 3. screen

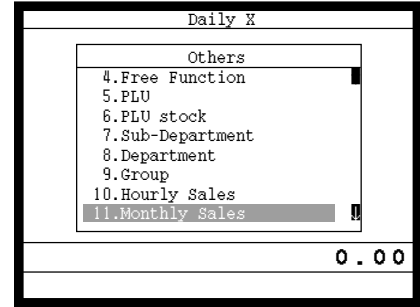

Step 4. screen

Step 5. Press **ESC/SKIP** repeatedly to return to the “Step 1. screen”.

### Report

X	MONTHLY	0000020	Read symbol/report title
			Report code
1.....			Date of a month
GROSS		1236.76	Gross symbol/No. of items
		- 12,202.57	Gross sales amount
NET	No	214	Net symbol/No. of net sales
		- 12,202.57	Net sales amount
<hr/>			
31.....			
GROSS		2132	
		- 14,187.57	
NET	No	205	
		- 13,398.76	
<hr/>			
TL			Total symbol
GROSS		9746.63	Gross symbol/No. of items
		- 161,022.49	Gross sales amount
		- 16.52	Average daily gross sales
NET	No	2351	Net symbol/No. of net sales
		- 161,022.49	Net sales amount
		- 68.49	Average daily net sales

# Reading the cash register's program

## The tree of P6 (program read) menu window

You can issue these kinds of report by tracing this tree.

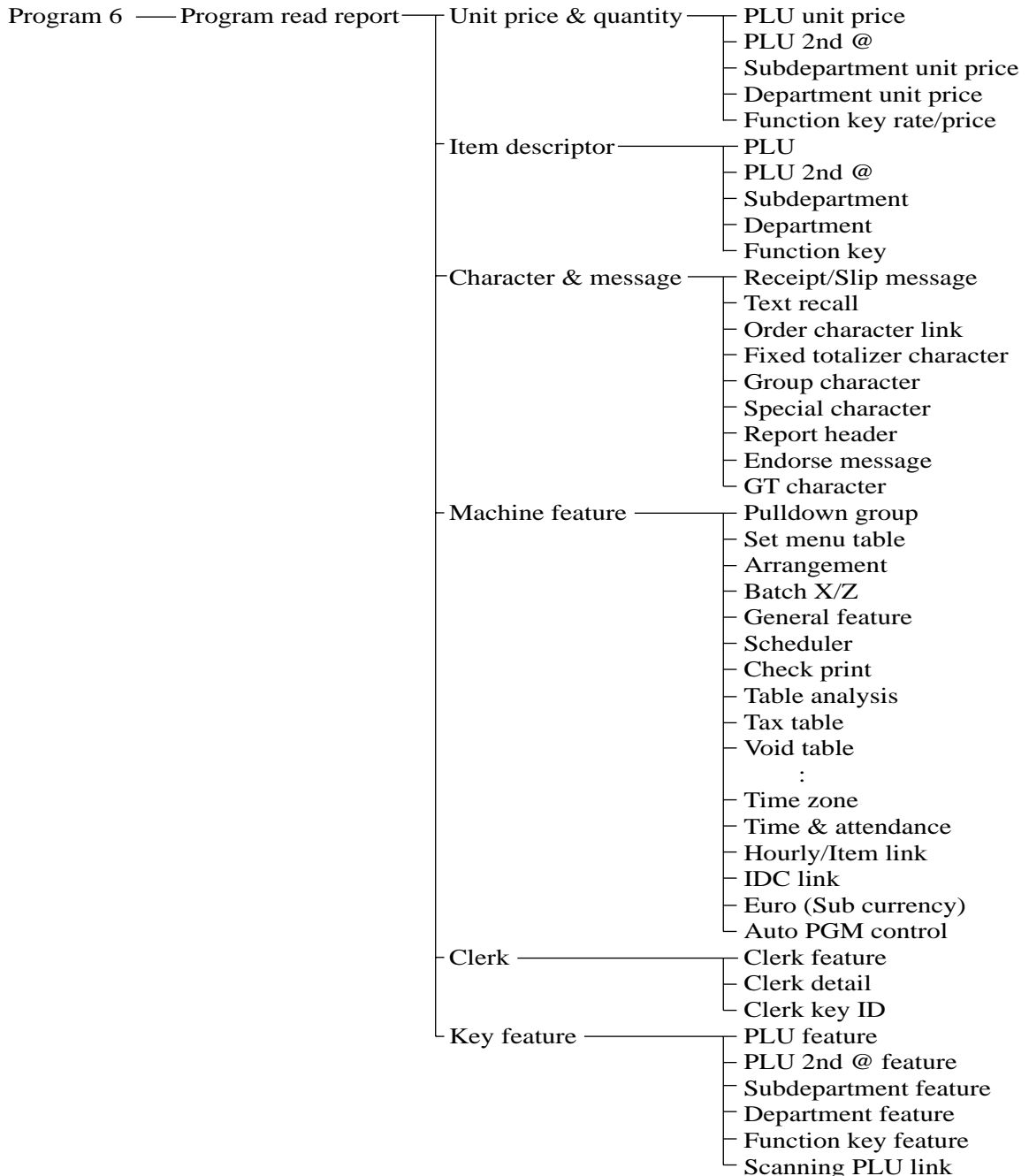

# Advanced Operations

## Procedure

Step 1. Press <PGM MODE> six times to turn Program 6 mode and press **YES**.

Step 2. Select an appropriate job and press **YES**.

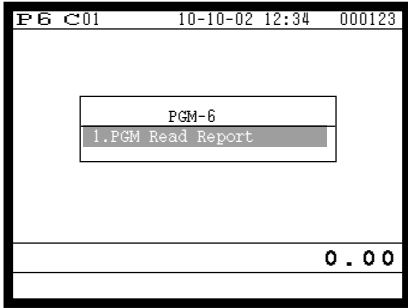

Step 1. screen

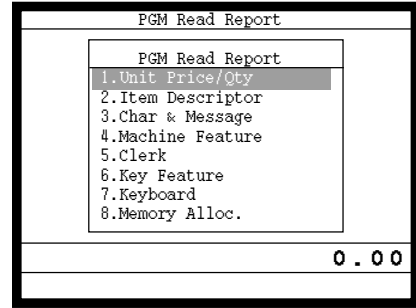

Step 2. screen

Step 3. Select an appropriate job and press **YES**. If the job requires range destination, Step 4 screen will appear.

Step 4. Enter the start/end range and press **YES**.

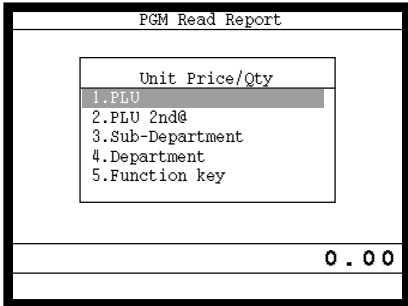

Step 3. screen

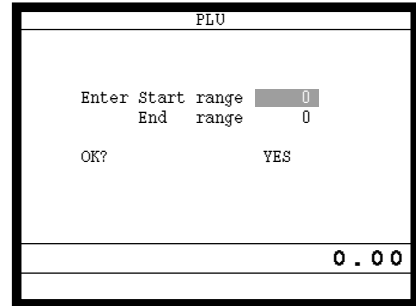

Step 4. screen

Step 5. Press **ESC/SKIP** repeatedly to return to the “Step 1. screen”.

## Report example

### Unit price and quantity

#### PLU unit price

PLU0001				PLU descriptor
0001-004			@12.34	Record No./File No./Unit Price
PLU0002				
0002-004			@1.00	

#### PLU 2nd @

PLU0001				PLU 2nd descriptor
0001-054	2		@23.45	Record No./File No./Unit quantity/2nd unit Price
PLU0002				
0002-054	1		@10.00	
PLU0003				
0003-054	0		@2.00	



### Subdepartment unit price

SUBDEPT01			Subdepartment descriptor
0001-003	@1.00		Record No./File No./Unit Price
SUBDEPT02			
0002-003	@2.00		
SUBDEPT03			
0003-003	@3.34		

### Department unit price

DEPT01			Department descriptor
0001-005	@12.34		Record No./File No./Unit Price
DEPT02			
0002-005	@2.34		
DEPT03			
0003-005	@1.34		

### Function key rate/price

%-	0013-002		Function key descriptor/Record No./File No.
	0%		Unit Price, percent rate or conversion rate
-	0018-002		
	@0.00		
CASH	0035-002		
	@0.00		

### Item descriptor

#### PLU

PLU0001			PLU descriptor
0001-004			Record No./File No.
PLU0002			

#### PLU 2nd unit price

PLU0001			PLU 2nd descriptor
0001-054			Record No./File No.
PLU0002			

### Subdepartment

SUBDEPT01	0001-003		Subdepartment descriptor/Record No./File No.
SUBDEPT02	0002-003		
SUBDEPT03	0003-003		

### Department descriptor

DEPT01	0001-005		Department descriptor/Record No./File No.
DEPT02	0002-005		
DEPT03	0003-005		

### Function key descriptor

RCT	0001-002		Function key descriptor/Record No./File No.
NEW/OLD	0002-002		
RC	0003-002		
DISP ON/OFF	0004-002		
CLK#1	0005-002		

# Advanced Operations

## Character and Message

### Receipt/Slip message

0001-032	YOUR RECEIP	Record No./File No.
T		Receipt message
0002-032	YOUR RECEIPT	
0003-032		

## Clerk

### Clerk feature

C01	001-007	Clerk name/Record No./File No.
	0001	Clerk secret code
	00	Drawer No.
	000111	
01-067	0000040000	Other program data
02-067	0000000000	
03-067	0000000000	
04-067	000000000000	
05-067	000000000000	
06-067	000000000000	
07-067	000000000000	
08-067	000000000000	
09-067	000000000000	
10-067	000000000000	
11-067	000000000000	
068	00000000	
069	000000000000	
C02	002-007	
	0002	

## Key feature

### PLU feature

PLU0001		PLU descriptor
0001-004	000000000000	Record No./File No./Elementary program
11-066	000000	Other program data
12-066	000000	
13-066	0000	
14-066	0	
	0	
15-066	@0.00	
16-066	00	
17-066	00	
20-066	0000	
21-066	000000000000	
22-066	000000	
PLU0002		

### PLU 2nd unit price feature

PLU0001		PLU 2nd @ descriptor
0001-054	000000000000	Record No./File No./Elementary program †
11-066	000000	Other program data
12-066	000000	Other program data
14-066	0	Other program data
PLU0002		
0002-004	000000000000	
11-066	000000	
12-066	000000	
14-066	0	
PLU0003		

### Subdepartment feature

SUBDEPT01			Subdepartment descriptor
0001-003	000000000000		Record No./File No./Elementary program
11-066	000000		Other program
15-066	@0.00		
16-066	00		
17-066	00		
20-066	0000		
21-066	00000000		
SUBDEPT02			

### Department feature

DEPT01			Department descriptor
0001-005	000000000000		Record No./File No./Elementary program
11-066	000000		Other program
15-066	@0.00		
16-066	00		
17-066	00		
20-066	0000		
21-066	00000000		
DEPT02			

### Function key feature

0001 CASH	000000000000	Record No./Key descriptor/Parameter
0002 CHARGE	000000000000	
0003 CREDIT	000000000000	
0004 %+	000000000000	
0005 CLEAR	000000000000	
0006 PGM MODE	000000000000	

# Troubleshooting

This section describes what to do when you have problems with operation.

## When an error occurs

Errors are indicated by an error codes. When this happens, you can usually find out what the problem is as illustrated below.

Press **C** and check the appropriate section of this manual for the operation you want to perform.

Prompt message	Meaning	Action
Operator mistake.	Operation error	Perform proper operation.
E001 Wrong mode.	Check tracking (Open mode error)	Return the mode to its original setting.
E003 Wrong operator.	Error clerk/Error clerk in check tracking	Input correct check number or assign the proper clerk.
E005 Insufficient memory.	Memory allocation over	Reallocate memory.
E011 Close the drawer.	Drawer compulsory	Close cash drawer.
E012 Journal paper end.	Journal paper end	Replace journal paper.
E014 Receipt paper end.	Receipt paper end	Replace receipt paper.
E015 Check R/J printer.	Internal R/J printer error	Check the internal R/J printer.
E016 Change back to REG mode.	Prohibit plural operation in RF/REG- mode	Switch to another mode and then back to the RF/REG- mode again.
E017 Enter Check/TBL number.	Check number compulsory	Input a check number.
E018 Enter Table number.	Table number compulsory	Input a table number.
E019 Enter Number of covers.	Cover compulsory	Enter the number of customers.
E020 Enter Seat number.	Seat number compulsory	Input a seat number.
E023 Stock running short.	Alarm when any item drops below its programmed minimum stock quantity during registration.	Perform stock maintenance.
E024 No stock is available.	Error when actual stock value for a registration items is a negative value.	Perform stock maintenance.
E028 Not found PLU or C/D is mismatch.	Scanning PLU is not found or OBR code is mismatched.	Re-enter the PLU code.
E029 No registration is possible while you are in the tender operation.	Attempted registration whilst partial tender operation is being done.	Finalize the transaction.
E031 Press ST key before Finalization.	ST compulsory	Press ST key.
E033 Enter tendered amount.	Amount tender compulsory	Enter tendered amount.
E035 Change amount exceeds the limit.	Change amount exceeds the limit.	Enter amount tendered again.
E036 Remove money from the drawer.	Contents of the drawer exceed the programmed limit — Sentinel function.	Perform pickup operation.
E037 Digit or Amount Limitation Over.	H.D.L., H.A.L., L.D.L. error	Enter correct unit price/amount.
E038 Perform Money Declaration	Money declaration compulsory	Perform money declaration.
E040 Issue Guest Receipt.	Guest receipt compulsory	Issue a guest receipt.
E041 Print Validation.	Validation compulsory	Perform validation operation.
E044 Print Cheque.	Check print compulsory	Perform check print operation.
E045 Print Check-Endorsement.	Check endorsement compulsory	Perform check endorsement operation.
E046 REG Buffer Full. Please Finalize or NB.	Registration buffer full	Finalize the transaction. Allocate sufficient buffer.
E047 Print bill.	Slip compulsory	Perform slip printing operation.
E048 Insert Slip Paper and retry.	Alarm when no paper is inserted in the Slip.	Insert new slip paper.
E049 CHECK memory full.	Check tracking index full/near end	Finalize and close the check number currently used.
E050 Detail memory full.	Check tracking memory full/near end	Finalize and close the check number currently used.
E051 CHK/TBL No. is occupied.	Attempt is made to use the <NEW CHECK> key to open a new check using a number that is already used for an existing check tracking memory.	Finalize and close the check that is currently under the number that you want to use or use a different check number.
E052 CHK/TBL No. is Busy.	Attempt to use the same check number whilst the specified number is being used in the other terminal.	Use another check number or close the check at that terminal.
E053 CHK/TBL No. is not opened.	Check number not found	Use the correct check number (if you want to reopen a check that already exists in the check tracking memory) or use <NEW CHECK> to open a new check.
E054 Out of CHK/TBL No. Range.	Check number range over	Enter correct number.
E056 Store range full.	All check number are occupied in range.	Recall the stored data.
E057 No item exists in detail.	Round repeat cannot be found in detail.	
E058 Enter post entry item.	Post entry item exists in detail.	Enter Post entry item.
E059 Press Eat-in or Take-out key.	Press eat-in or take-out key.	Press Eat-in or Takeout key.
*****	Printer offline. "*****" means ECR logical ID	
E060 Printer offline.	and priter number.	
*****	Printer downed. "*****" means ECR logical ID	
E061 Printer error.	and printer number.	The contents are printed on the backup printer.

# Troubleshooting

Prompt message	Meaning	Action
***** E061 Printer error. YES:Retry to print. NO :Backup to R/J printer. ESC:Discard data.	Printer downed. "*****" means ECR logical ID and printer number.	Follow the prompt message.
***** E062 Printer paper end.	Paper near-end/end "*****" means ECR logical ID and printer number.	The contents are printed on the backup printer.
***** E062 Printer paper end. YES:Retry to print. NO :Backup to R/J printer. ESC:Discard data.	Paper near-end/end "*****" means ECR logical ID and printer number.	Follow the prompt message.
E064 Printer buffer full. YES:Retry to print. NO :Backup to R/J printer. ESC:Discard data.	Print buffer full at sender side	Follow the prompt message.
***** E070 Terminal out of action. Cannot print.	Down at target ECR which has printer "*****" means ECR logical ID and printer number.	
***** E071 Target terminal printer BF full. YES:Retry to print. NO :Backup to R/J printer. ESC:Discard data.	Printer buffer full at target ECR which has printer "*****" means ECR logical ID and printer number.	Follow the prompt message.
***** E072 Target printer terminal is busy.	Busy at target ECR which has printer "*****" means ECR logical ID and printer number.	
***** E073 Your receipt/order may not be issued. YES:Retry to print. NO :Backup to R/J printer. ESC:Discard data.	Time out at ECR which has printer "*****" means ECR logical ID and printer number.	Follow the prompt message.
E075 Negative Balance, cannot be finalized.	Attempted finalization when balance is less than zero.	Register item(s) until the balance becomes positive amount.
E080 Electronic Journal Full Please clear E-Journal.	Electronic journal full	Reset the electronic journal memory.
E082 ***** Illegal Data *****	Illegal Electronic journal data	
E083 Cannot create E-Journal. Check Flash memory.	Electronic journal file cannot be created.	Check flash memory.
***** E105 Check/TBL tracking Master down. Please call Manager!! YES:Retry for connection. NO :Remove it from system.	CHK master down "*****" means ECR logical ID.	Follow the prompt message.
***** E106 Check/TBL tracking Backup master down. Please call Manager!! YES:Retry for connection. NO :Remove it from system.	CHK BM down "*****" means ECR logical ID.	Follow the prompt message.
***** E107 Both Master&Backup master down. CHK/TBL tracking or Clerk interrupt is not available.	CHK M/BM down "*****" means ECR logical ID.	
***** E108 CHK/TBL Master is removed from system.	Master down then take it off from system "*****" means ECR logical ID.	
***** E109 CHK/TBL Backup master is removed from system.	Backup master down then take it off from system "*****" means ECR logical ID.	
E110 CHK data mismatch between Master and Backup master.	Data mismatch has occurred.	
E130 Middle of Pick up or Loan Press Cancel Key.	During picking up	Follow the prompt message.
E131 Middle of <Bill Copy> Press Cancel Key.	During bill copy	Follow the prompt message.
E133 Middle of <Media Change> Press Cancel Key.	During media change	Follow the prompt message.

# Troubleshooting

Prompt message	Meaning	Action
E134 Middle of Clerk Transfer Press ESC Key.	During clerk transfer	Follow the prompt message.
E136 Middle of Separate Check Press ESC key.	During separate check	Follow the prompt message.
E139 Not allowed to be negative by Minus/Coupon key.	Credit balance error	Enter proper minus/coupon amount.
E140 Wrong menu.	This sheet holder is prohibited by program.	Set correct sheet holder.
E141 Press <TRAY TTL> twice before finalization.	<TRAY TOTAL> key is not pressed twice before finalization.	Follow the prompt message.
E145 Arrangement syntax error.	Arrangement syntax error	Program the arrangement again.
E150 Incorrect value entry.	Incorrect entry for PGM	Enter proper value again.
E151 Incorrect Key Pressed.	Linking is incorrect.	Enter proper key again.
E152 PGM File or Memory number does not Exist.	No such file, no such record	Enter file/record number again.
E164 Employee No. is not Found in the Employee File.	Employee No. is not set in the Employee File.	Enter employee number again.
E165 Employee No. is not Clocking-in.	Employee has not done CLOCK-IN operation yet.	Perform CLOCK-IN operation.
E166 Employee No. is Occupied.	Employee who has done CLOCK-IN operation attempts to operate CLOCK-IN again.	Enter the proper employee number again.
E167 Incorrect Job code.	Employee attempts to operate CLOCK-IN with incorrect JOB code.	Enter proper job code.
E168 Your Operation is out of Schedule. Please Call Manager.	Employees operate CLOCK-IN/OUT in not allowance time.	Follow the prompt message.
E169 Work Hours Exceeded. Please Call Manager.	Overtime work.	Follow the prompt message.
E170 No Shift Remains in the Schedule. You cannot Clock-in.	There is no available shift left.	
E171 Please Break-out and Retry.	Employee attempts to operate CLOCK-OUT whilst he/she is in a break time.	Follow the prompt message.
E172 Break Hours Exceeded. Please Call Manager.	Break hours are exceeded.	Follow the prompt message.
E173 This employee is at work now.	Employee is at work without break.	
E174 This employee is taking a break now.	Employee who has not done BREAK-OUT operation attempts to operate BREAK-IN.	
E175 Please Clock-in/Break-out before you sign on. or Please Call Manager.	Sign on after you clock-in or break out.	Follow the prompt message.
E176 You cannot Clock-in. Please reset Employee Report.	Employee Report has not been reset.	Follow the prompt message.
E177 Time&Attendance Data Communication Error. Please Call Manager.	Time & Attendance Data communication error.	Follow the prompt message.
E180 IDC FILE (1) memory full. Please clear IDC data.	IDC FILE (1) memory is full of items.	Follow the prompt message.
E181 IDC FILE (2) memory full. Please clear IDC data.	IDC FILE (2) memory is full of items.	Follow the prompt message.
E182 IDC FILE (3) memory full. Please clear IDC data.	IDC FILE (3) memory is full of items.	Follow the prompt message.
E200 Insert CF Card.	CF card is not inserted to the slot.	Insert CF card.
E201 Format error.	CF card data or formats illegal.	Check the CF card.
E203 Insufficient memory.	Insufficient memory is remained in CF card.	Format or use a new CF card.
E205 The file already exists. Do you replace? YES:Replace the file. NO :Input new name.	File name duplication error	Follow the prompt message.

## When the register does not operate at all

Perform the following check whenever the cash register enter an error condition as soon as you switch it on. The results of this check are required by service personnel, so be sure to perform this check before you contact a CASIO representative for servicing.

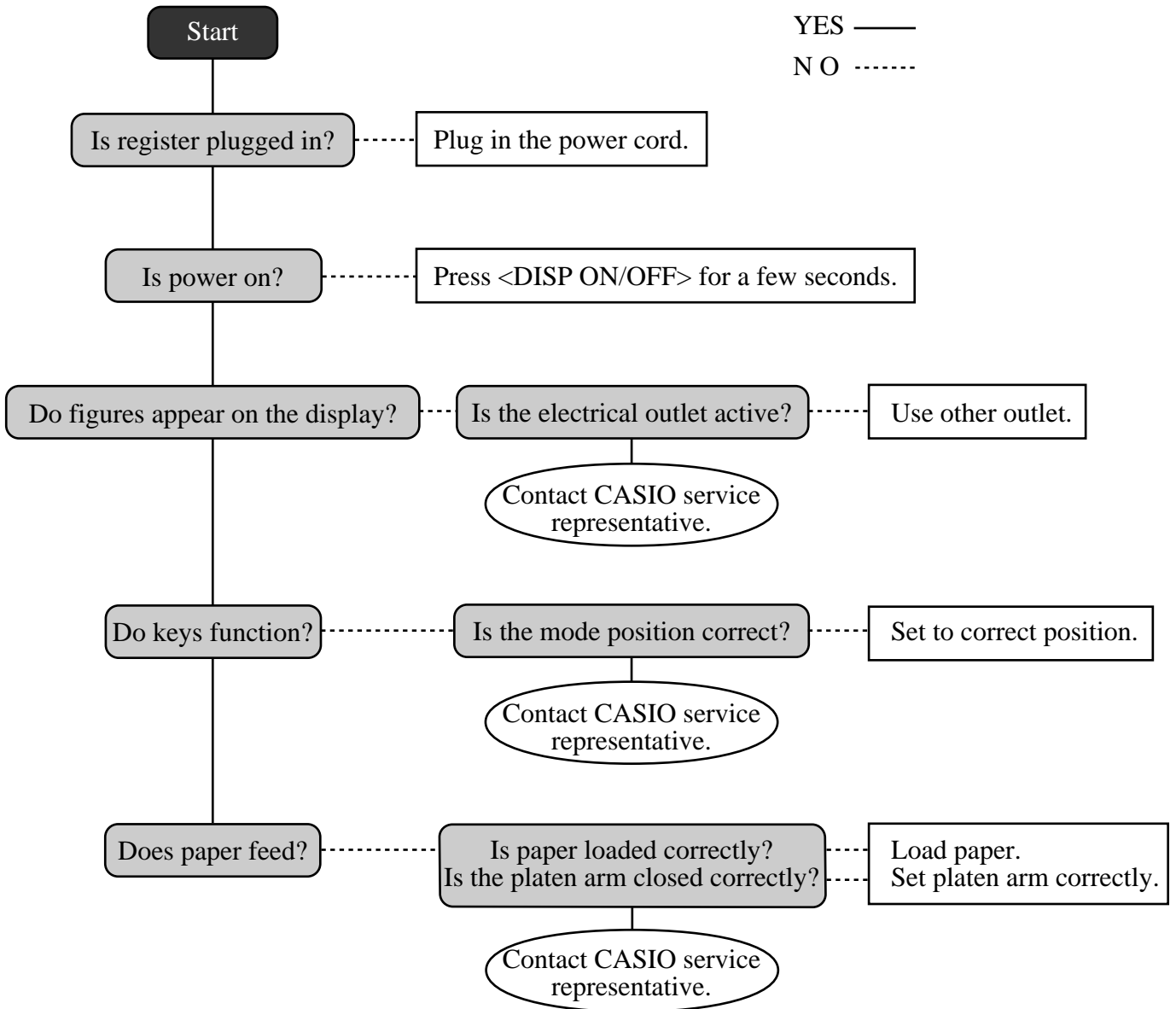

## In case of power failure

If the power supply to the cash register is cut by a power failure or any other reason, simply wait for power to be restored. The details of any on-going transaction as well as all sales data in memory are protected by the memory backup batteries.

- Power failure during a registration  
The subtotal for items registered up to the power failure is retained in memory. You will be able to continue with the registration when power is restored.
- Power failure during printing a read/reset report
- Power failure during printing of a receipt and the journal  
Printing will resume after power is restored. A line that was being printed when the power failure occurred is printed in full.

The memory protection battery is constantly charging and discharging as you switch the cash register on and off during normal operations. This causes the capacity of the battery to decrease after approximately five years of use.

### **Important !**

- Remember a weak battery has the potential of losing valuable transaction data.
- A label on the back of the cash register shows the normal service period of the battery installed in your cash register.
- Have the battery replaced by your dealer within the period noted on this label.



## To replace journal paper



### Step 1

Turn on the cash register and remove the printer cover. (If the cover is locked, unlock by using the printer cover key before this step.)



### Step 5

Slide the printed journal from the take-up reel.



### Step 2

Press **JOURNAL FEED** to feed about 20 cm of paper.



### Step 6

Open the platen arm.



### Step 3

Cut the journal paper at the point where nothing is printed.

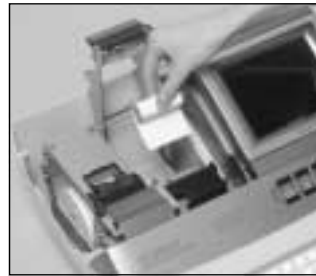

### Step 7

Remove the old paper roll from the cash register.



### Step 4

Remove the journal take-up reel from its holder.

### Step 8

Load new paper. Go to the step 3 described on page 13 of this manual.

## To replace receipt paper



### Step 1

Turn on the cash register and remove the printer cover.  
(If the cover is locked, unlock by using the printer cover key before this step.)



### Step 2

Open the platen arm.



### Step 3

Remove the old paper roll from the cash register.

### Step 4

Load new paper.  
Go to the step 3 described on page 12 of this manual.

## Options

Wetproof cover:	WT-78/79 (for TE-8000F) WT-62 (for TE-8500F)	Slip printer:	SP-1300
Remote display:	QT-2163D	Cable:	PRT-CB-8C
Sheet holder kit:	SH-KIT10 (for TE-8000F)	Power supply:	AD31U or AD31E
Hand held scanner:	HHS-15	External printer:	UP-350, UP-250
		Cable:	PRT-CB-8A or PRT-CB-8B
		Power supply:	PS-180 and AC-170

Consult with your CASIO dealer for details.

# Specifications

## Input method

Entry: 10-key system  
 Function: Full key system

## Display

Main: Color LCD: 320 × 240 dots  
 Customer: 10-digit 7-segment LED with 2 transaction indicators

## Printer

Receipt: Thermal alpha-numeric system 29 digits, receipt on/off key  
 Store name or slogan is printed automatically  
 Graphic logo: 20 (H) × 53 (W) mm  
 Journal: Thermal alpha-numeric system 29 digits  
 Automatic take up roll winding  
 Journal paper near end sensor (option)  
 Paper roll: 58 (W) × 83 (D) mm  
 Paper feed: Separate for receipt and journal  
 Print speed: About 20 l/s

## Listing capacity

Amount: 99999999  
 Quantity: 9999.999  
 Tended amount: 9999999999  
 Percent: 99.99  
 Tax rate: 9999.9999  
 Numbers: 9999999999

## Chronological data

Date print: Automatic date printout on receipt or journal, automatic calendar  
 Time print: Automatic time printout on receipt or journal, 24-hour system/12-hour system

## Alarm

Key catch tone, error alarm, sentinel alarm

## Memory protection battery

48-hour full charge protects memories for approximately 30 days.  
 Battery should be replaced every five years.

## Power supply/power consumption

See the rating plate.

## Operation temperature

0°C ~ 40°C (32°F ~ 104°F)

## Humidity

10 ~ 85%

## Dimensions and weight

215 mm (H) × 410 mm (W) × 491 mm (D) / 8kg ...without drawer  
 (8 15/32" (H) × 16 5/32" (W) × 19 11/32" (D)/ 17lbs. 10oz)

Totalizers	Contents					
Category	No. of totalizers	Amount (10 digits)	No. of items (6 integer/3 decimal)	Count (4 digits)	No. of customers (6 digits)	Periodic totalizers
Department	Up to 4	✓	✓			✓
PLU	Up to 324	✓	✓			
Clerk	6	✓	✓	✓	✓	✓
Hourly sales	24	✓			✓	
Monthly sales	32	✓	✓		✓	
Transaction	Variable with program					✓
Non resettable grand total	3	✓ (16 digits)				
Reset counter				✓		
Consecutive No.	1			✓ (6 digits)		

* Specifications and design are subject to change without notice.

## A

- add check 24, 58
- adding to check 55
- alphabet key 84
- arrangement 24, 73
- arrow key 22
- assigning a clerk 30
- auto new balance function 54
- Auto PGM 18

## B

- backspace key 84
- batch printing 53
- bill copy 24, 63
- bottom message 28
- break-in/out key 24

## C

- cancel 23, 47
- CAP key 84
- cash in drawer 49
- cash/amount tendered key 23
- CF (compact flash card) 18
- change 31, 32
- character code list 85
- character editing 86
- character entering 84
- character keyboard 84
- charge key 24
- check 39
- check endorsement key 24
- check in drawer 49
- check key 23
- check number 21
- check number method 54
- check print key 24
- check tracking 21, 54
- clear key 22
- clerk 28, 98
- clerk button 18, 19, 30
- clerk interrupt 52
- clerk number key 24, 30
- clerk programming 80
- clerk sign off 30
- clerk sign on 30
- clerk transfer 60
- clerk transfer key 24
- clock-in/out key 24
- closing check memory 56
- commercial message 28
- condiment PLU 61
- consecutive No. 28
- contrast control 16
- contrast control knob 16, 17
- correct not registered item 45
- correct previously registered item 47
- correct registered item 46
- correction 45

- coupon 24, 69
- coupon 2 24, 69
- credit 23, 39
- credit in drawer 49
- cube 24
- currency exchange 24, 74
- cursor key 84
- customer number 22, 28

## D

- daily sales report 48, 91
- Dallas key 16, 17, 18, 19, 30
- date set 14
- date/time key 23
- declaration key 24
- delete key 84
- department descriptor 97
- department key 24
- department number key 24
- deposit 24, 62
- descriptor programming 81
- discount 22, 36, 37
- discount total 49
- DISP ON/OFF 18
- display 20
- displaying the time and date 31
- double size letter key 84
- drawer 19
- drawer lock 19
- drawer open key 19
- Dutch account key 24

## E

- eat-in key 24
- electronic journal display key 24
- error code 100
- error correct key 23
- ESC/SKIP key 22, 84
- Euro 22, 40
- external printer 106

## F

- financial read report 89
- first unit price key 24
- flat-PLU 23, 32, 35, 81
- function key descriptor 82, 97

## G

- grand total 49
- gross total 49
- guest receipt 50, 56

## H

half height character 28  
hand held scanner 106  
high amount limitation 35  
home position key 22  
hourly sales report 93  
house Bon key 24

## I

individual clerk report 90  
insert key 84  
item descriptor 21  
item quantity 21

## J

journal 13, 28  
journal paper replacement 105

## K

Ketten Bon key 24  
key descriptor 21  
keyboard 16, 17, 22, 23

## L

list key 24  
list number 24, 62  
loan 24, 78  
local currency 40  
locking platen 12, 13  
logo message 28

## M

machine No. 28  
main display 16, 17, 20  
media change 24, 78  
menu sheet 16, 17, 27  
menu shift 22, 32  
merchandise subtotal key 24  
message programming 81  
minus key (reduction) 22  
mixed tender 39  
mode keys 16, 17, 18  
money declaration 88, 90  
monthly sales report 94  
multiplication 23, 33

## N

net total 49  
new balance 23, 55  
new check 24, 54  
new/old check 23, 54, 57  
no key 22  
no sale 23, 24, 47  
non-add 23, 24  
normal receipt key 24  
number of customer 21, 51

## O

OBR (optical barcode reader) key 24  
old check key 24, 54  
open 2 76  
open check 55  
open key 22  
operator number 60  
option 106

## P

page down key 22  
page up key 22  
paid out 22, 44  
paper feed key 22  
paper installation 12  
paper loading 12  
PGM MODE 18  
pick up 25, 78  
platen 13  
platen arm 13, 16, 17  
PLU 2nd descriptor 96  
PLU descriptor 96  
PLU report 92  
plus 25, 68  
pop-up display 16, 17, 20  
post entry key 25  
post receipt 22, 50  
power failure 104  
premium 25, 68  
preparation PLU 61  
preset amount tender 72  
preset price 35  
preset tax status 35  
price inquiry key 25  
price key 25  
printer 13, 16, 17  
printer cover 16, 17  
printer cover key 16, 17  
printing slip 53  
program reading 95

## Q

quantity/for key 25

## R

read report 87  
recall key 25  
receipt 12, 28  
receipt paper replacement 106  
receipt/slip message programming 83  
received on account 22, 44  
reduction 36, 38  
REF MODE 18, 43, 49  
reference No. print 39  
refund 22, 42  
REG MODE 18  
REG- MODE 18  
release HAL 76  
release specific compulsion 76  
remote display 106  
remove the sheet holder 26  
repeat 32  
replace the sheet holder 26  
report code 49  
report title 49  
reset counter 49  
reset report 48, 87  
reverse display key 25  
roll paper 16, 17  
roll paper installation 12  
round repeat key 25

## S

scanning PLU 79  
seat number key 25  
second unit price 25, 70  
selective item subtotal key 25  
separate check 25, 59  
set menu 65  
sheet holder 106  
shift key 84  
shift PLU key 25  
single item 67  
single item sale 32  
slip 53  
slip back feed/release key 25, 53  
slip feed/release key 25, 53  
slip print key 25  
slip printer 106  
space key 84  
square key 25  
stock (negative) 66  
stock (under minimum level) 66  
stock check 66  
stock inquiry 25, 66  
store key 25  
sub window 21  
subdepartment descriptor 97  
subdepartment key 25  
subdepartment number key 25  
substitution 25  
subtotal key 23

## T

table number 21, 25, 28, 55  
table number method 54  
table transfer 22, 60  
take-up reel 16, 17  
takeout key 25  
tax amount 49  
tax exempt key 25  
tax shift key 25  
tax status 21  
taxable amount 49  
taxable amount subtotal key 25  
ten key pad 23  
text print key 25  
text recall 25, 61  
tilt LCD 17  
time set 15  
tip key 25  
tips 65  
tray total 25, 64

## U

unit price inquiry 79

## V

validation key 25  
VAT breakdown 77  
VAT key 25  
void key 23

## W

wetproof cover 106

## X

X/Z menu window 87  
X/Z MODE 18

## Y

yes key 22, 84



**CASIO®**

**CASIO COMPUTER CO., LTD.**  
6-2, Hon-machi 1-chome  
Shibuya-ku, Tokyo 151-8543, Japan

TE-6000*E

MO0212-A Printed in Malaysia

Printed on recycled paper